



Department of
Veterans Affairs

Office of Construction & Facilities Management

designguide

December 2010

rev 12/01/2017

MENTAL HEALTH FACILITIES



Table of Contents

1.0 INTRODUCTION

1.1	Foreword	1-1
1.2	Acknowledgements	1-5
1.3	Design Guide Introduction	1-9
1.4	Definitions	1-11
1.5	Abbreviations	1-13
1.6	Legend of Symbols	1-16

2.0 GENERAL OPERATIONAL NARRATIVE

2.1	Operational Summary	2-1
2.2	Guiding Principles	2-5
2.3	Operational / Planning Recommendations	2-7
2.3.1	General Trends in Mental Health Design	
2.4	Design Recommendations	2-10
2.4.1	Flexibility	
2.4.2	Efficiency	
2.4.3	Patient Needs	
2.4.4	Risk Reduction	

3.0 PLANNING AND DESIGN CRITERIA

3.1	Introduction	3-1
3.2	Inpatient Mental Health Units	3-3
3.2.1	Introduction	
3.2.2	Current Examples	
3.2.3	Inpatient Mental Health Unit Relationship Diagram	
3.2.4	Inpatient Entrance/Reception	
3.2.5	Patient Room	
3.2.6	Patient Bathroom	
3.2.7	Patient Activity Areas	
3.2.8	Nursing Station Design and Operations	
3.2.9	Outdoor Courtyards	
3.2.10	Accommodations for Women Veterans and Other Patient Subgroups	
3.3	Mental Health Residential Rehabilitation Treatment Program (MH RRTP) Facility	3-38
3.3.1	Introduction	
3.3.2	Overall Facility Relationship Diagram	
3.3.3	Resident Room	
3.3.4	Multiple Occupancy Living Unit	
3.3.5	Resident Activity Areas	
3.3.6	Outdoor Activity Spaces	
3.4	Outpatient Services	3-46
3.4.1	Introduction	
3.4.2	Mental Health Clinic	
3.4.3	Substance Abuse Clinic	

- 3.4.4 Psychosocial Rehabilitation and Recovery Center (PRRC)
- 3.4.5 Psychology Services
- 3.4.6 Primary Care-Mental Health Integration Services

4.0 TECHNICAL NARRATIVE

4.1	Codes and Standards	4-1
4.1.1	National Codes and References	
4.1.2	Other Recommended References and Standards	
4.1.3	Local Codes and References	
4.1.4	HIPAA	
4.1.5	Emergency Provisions	
4.2	Site Design Guidelines	4-8
4.2.1	Introduction	
4.2.2	Planning	
4.2.3	Topography	
4.2.4	Zoning	
4.2.5	Archeological/Historic Features	
4.2.6	Roadways	
4.2.7	Site Signage/Wayfinding	
4.2.8	Proximity to Adjoining Facilities	
4.2.9	Shared Site Features	
4.2.10	Utility Access	
4.2.11	Services	
4.2.12	Landscaping	
4.2.13	Inpatient Exterior Spaces	
4.2.14	Covered Entry	
4.3	Architecture	4-15
4.3.1	Introduction	
4.3.2	Exterior Architecture	
4.3.3	Patient and Staff Safety/Security Overview	
4.3.4	Interior Wall and Ceiling Construction	
4.3.5	Door Construction and Hardware	
4.3.6	Windows and Glazing	
4.4	Interior Design	4-20
4.4.1	Introduction	
4.4.2	Lighting	
4.4.3	Acoustics	
4.4.4	Interior Finishes	
4.4.5	Wayfinding & Signage	
4.4.6	Wall Mounted Items	
4.4.7	Patient Furnishings	
4.5	Structural	4-30
4.6	Equipment	4-30
4.7	Heating, Ventilation and Air Conditioning	4-31
4.8	Plumbing	4-34
4.9	Electrical	4-37
4.10	Communications	4-40
4.11	Waste Management	4-42
4.12	Transportation	4-43

5.0 MENTAL HEALTH & BEHAVIORAL CARE UNITS

Reference Space Criteria Chapter 110

5.1	Patient Room, One Bed / Bathroom, Standard	5-2
5.2	Patient Room, One Bed / Bathroom, Accessible	5-10
5.3	Patient Room, One Bed / Bathroom, Bariatric	5-18
5.4	Patient Room, Two Bed / Bathroom, Standard	5-26
5.5	Seclusion Room: Isolation / Seclusion / Anteroom	5-34
5.6	Nursing Station / Nurse Workroom / Medication Room / Team Room	5-39
5.7	Dining Room / Serving / Pantry	5-47
5.8	Dayroom	5-53
5.9	Group Room	5-57

6.0 MENTAL HEALTH RESIDENTIAL REHABILITATION TREATMENT PROGRAM (MH RRTP) FACILITY

Reference Space Criteria Chapter 312 MH RRTP

6.1	Two Bedroom Suite	6-2
6.2	Bedroom, One-Bed / Bathroom, Standard	6-8
6.3	Bedroom, One-Bed, Accessible / Bathroom	6-14
6.4	Bedroom, One-Bed, Bariatric / Bathroom	6-20
6.5	Bedroom, Two-Bed, Standard / Bathroom	6-26
6.6	Resident Suite: Living Area / Dining Area / Kitchenette / Storage	6-32
6.7	Lounge, Resident	6-37
6.8	Multi-Purpose Room / Kitchenette	6-41
6.9	Resident Education / Conference / Group Room	6-47
6.10	Dining Room / Serving Line / Training Kitchen	6-51
6.11	Recreation Therapy Room	6-58

7.0 OUTPATIENT SERVICES

Reference Space Criteria Chapters 202, 260,261 and 272

7.1	Examination Room	7-2
7.2	Treatment Room	7-7
7.3	Group Therapy Room	7-12
7.4	Group Testing Room	7-16
7.5	Biofeedback Lab Treatment & Control Room	7-20
7.6	Office, Counselor	7-26
7.7	Social Activities / Dining / Multi-Purpose	7-30
7.8	Classroom/ Group Room	7-34
7.9	Occupational Therapy	7-38

Index of Figures and Tables

Figure No.	Description	Page No.
Figure 1.6.1	Legend of Symbols	1-16
Figure 1.6.2	Legend of Symbols	1-17
Figure 1.6.3	Legend of Symbols	1-18
Figure 1.6.4	Legend of Symbols	1-19
Figure 3.2.2.1	Proposed Inpatient Mental Health Facility VA Palo Alto – Overall View	3-5
Figure 3.2.2.2	Proposed Inpatient Mental Health Facility VA Palo Alto – Overall Floor Plan	3-6
Figure 3.2.2.3	Proposed Inpatient Mental Health Facility VA Palo Alto – Typical Inpatient Unit	3-7
Figure 3.2.3	Inpatient Mental Health Unit Relationship Diagram	3-9
Figure 3.2.5.1	Typical Patient Room	3-11
Figure 3.2.5.2	Typical Patient Room – Aerial View	3-12
Figure 3.2.5.3	Typical Patient Room – Aerial View	3-12
Figure 3.2.5.4	Sheet Vinyl Flooring	3-13
Figure 3.2.5.5	Wood Profile Rubber Floor Base	3-13
Figure 3.2.5.6	Wainscot Paneling	3-13
Figure 3.2.5.7	Standard Patient Platform Bed	3-14
Figure 3.2.5.8	Standard Recessed Fluorescent Fixture	3-16
Figure 3.2.5.9	Wet/Vandal Down-light	3-16
Figure 3.2.5.10	Over-bed Light Fixture	3-16
Figure 3.2.5.11	Typical Secure Diffuser	3-17
Figure 3.2.5.12	Secure Sprinkler Head	3-17
Figure 3.2.5.13	Anti-Ligature Door Hardware	3-18
Figure 3.2.5.14	Manual Patient Room Lock – Patient Side	3-18
Figure 3.2.6.1	Door Top Pressure Sensitive Alarm	3-19
Figure 3.2.6.2	Door Top Pressure Sensitive Alarm	3-19
Figure 3.2.6.3	Hinge Detail	3-19
Figure 3.2.6.4	Out-swinging Door with Sloped Top	3-20
Figure 3.2.6.5	Sloped Patient Door Detail	3-20
Figure 3.2.6.6	Sloped Door Elevation	3-20
Figure 3.2.6.7	Sliding Door	3-21
Figure 3.2.6.8	Porcelain Toilet Option	3-22
Figure 3.2.6.9	Bowl / Faucet	3-22
Figure 3.2.6.10	Standard Shower Control Panel	3-23
Figure 3.2.6.11	Solid Surface Shower Pan	3-23
Figure 3.2.6.12	Solid Surface Shower Wall Panels	3-23
Figure 3.2.6.13	Safety Mirror	3-25
Figure 3.2.6.14	Safety Toilet Paper Dispenser	3-25
Figure 3.2.6.15	Safety Grab Bar	3-25

Index of Figures and Tables (con't)

Figure No.	Description	Page No.
Figure 3.2.6.16	Collapsible Clothing Hooks	3-25
Figure 3.2.6.17	Recessed Paper Towel Dispenser	3-25
Figure 3.2.6.18	Safety Soap Dispenser	3-25
Figure 3.2.7.1	Handrails – Closure Detail	3-27
Figure 3.2.7.2	Handrails Example	3-27
Figure 3.2.7.3	Wall Guard Example	3-27
Figure 3.2.7.4	High Impact Panel Wainscot	3-27
Figure 3.2.7.5	Inpatient Living Room	3-28
Figure 3.2.7.6	View to Dining Area	3-29
Figure 3.2.7.7	Lounge Chair Example	3-29
Figure 3.2.7.8	Lounge Chair Example	3-29
Figure 3.2.7.9	Dining Room Chair Example	3-30
Figure 3.2.7.10	Dining Room Table Example	3-30
Figure 3.2.8.1	Nursing Station – Typical Option	3-32
Figure 3.2.8.2	Nursing Station – Optional Glass Partition	3-32
Figure 3.2.8.3	Nursing Station – VA Palo Alto	3-33
Figure 3.2.9.1	Enclosed Courtyard Example – VA Tuscaloosa, AL	3-35
Figure 3.2.9.2	Outdoor Courtyard Example - Sheppard-Pratt Towson, MD	3-35
Figure 3.3.1.1	Pittsburgh, PA – VA Domiciliary Main Entry View	3-40
Figure 3.3.1.2	Pittsburgh, PA – VA Domiciliary Reception Area	3-41
Figure 3.3.1.3	Pittsburgh, PA – Detail View of Residential Units	3-41
Figure 3.3.2	Overall Facility Relationship Diagram	3-42
Figure 3.3.3.1	Patient Room Example	3-43
Figure 3.3.3.2	Double Occupancy Room Example	3-43
Figure 3.3.4	Typical Living Unit Example – VA Pittsburgh	3-44
Figure 3.3.5.1	Recreation Therapy Room	3-45
Figure 3.3.5.2	Teaching Kitchen, Bedford VA	3-45
Figure 3.3.6	Outdoor Activity Spaces	3-45
Figure 3.4.2	Mental Health Clinic Relationship Diagram	3-48
Figure 3.4.3	Substance Abuse Clinic Relationship Diagram	3-51
Figure 3.4.4	Psychosocial Rehabilitation and Recovery Center	3-55
Figure 3.4.5	Psychology Services Relationship Diagram	3-57
Figure 4.4.2.1	Wet/Vandal Down-light	4-21
Figure 4.4.2.2	Standard Recessed Fluorescent Fixture	4-21

Index of Figures and Tables (con't)

Figure No.	Description	Page No.
Figure 4.4.4.1	Sheet Vinyl Flooring	4-23
Figure 4.4.4.2	Solid Surface Shower Pan	4-24
Figure 4.4.4.3	Wood Profile Rubber Floor Base	4-25
Figure 4.4.4.4	Wainscot Paneling	4-26
Figure 4.4.5.1	Standard Room Sign	4-27
Figure 4.4.5.2	Standard Room Sign	4-27



Department of
Veterans Affairs



Office of Construction &
Facilities Management

Section 1

INTRODUCTION

MENTAL HEALTH FACILITIES DESIGN GUIDE



1.0. INTRODUCTION

1.1. Foreword

Mental health facility design is a critical component of patient care. The design of mental health facilities affects how services are provided and the efficiency with which care is delivered. Equally, if not more important, than its direct functional impact, however, is the psychological impact mental health facility design has on its users. Facility design impacts the beliefs, expectations, and perceptions patients have about themselves, the staff who care for them, the services they receive, and the larger health care system in which those services are provided. Moreover, facility design can also have a significant impact on the beliefs, attitudes, and behaviors of staff and on how staff identify and interact with patients and the environment.

This Design Guide is intended to be a transformational document, reflecting the important psychological impact environments have on patients and staff. In addition to providing technical architectural and engineering specifications, this Design Guide emphasizes principles and strategies for building state-of-the-art, recovery-oriented environments for mental health settings in the Department of Veterans Affairs (VA). As such, this Design Guide reflects a new vision and philosophy for designing mental health facilities that is rooted in hope, healing, and recovery. This vision and philosophy is conveyed and operationalized in words and images on the pages that follow. Strong emphasis is placed on design approaches that incorporate home-like, non-institutional, and patient-centered environments that imbue healing, familiarity, and a sense of being valued.

The impact of mental health and other health care environments on users occurs at a number of levels, including the architectural and interior design levels. The architectural level includes aspects of the external facility, which serves as a user's (and non-user's) first introduction to the facility and impacts initial impressions and expectations. This also includes the external grounds and the degree of visual and physical access to nature incorporated into the design. The architectural level also includes the internal architectural environment, including the size, layout, and configuration of space. The interior design level includes furniture, flooring, wall color, texture, trim, use of artwork, and other aesthetic features. This Design Guide addresses each of these key components and provides guidance on creating home-like, warm, and welcoming settings and structures at each of these levels, based on available evidence and best practices.

In serving as a transformational resource, this Design Guide is intended to help advance a new treatment paradigm in inpatient psychiatry and residential and outpatient settings that emphasizes recovery, rather than symptom monitoring and stabilization, for patients with even the most severe mental illnesses. This new design approach is being implemented throughout the Veterans Health Administration and represents a significant departure from traditional approaches to mental health facility design.

The Design Guide also places important emphasis on patient safety. Developing mental health facilities that are safe and healing are not incompatible processes or goals. Healing environments can be designed as safe environments. Moreover, to the extent that the environment of care in inpatient and other mental health settings is healing and recovery-oriented, it is likely to enhance patient safety; warm, welcoming, and familiar environments often promote a sense of calm in patients and enhance their connection to their surroundings (often referred to as “place attachment”), rather than feel detached from or in opposition to it.

Patient engagement is also a critical component of patient safety. When patients feel connected to staff, they are more likely to respond to or seek out these individuals in moments of distress, which can prevent or deescalate personal crisis. For this reason, it is important that environmental design, as well as clinical processes, facilitate staff interaction and connection with patients and discourage isolation or detachment.

Significantly, the effort to promote healing and patient-centered mental health care environments nationally in VA occurs at the same time VA is working to transform its mental health care delivery system. As part of this transformation process, VA is working to develop a treatment culture that emphasizes recovery and a system where evidence-based mental health services are the standard of care and widely available from coast to coast. The delivery of such services in environments that send parallel messages of recovery and hope is critical to the success of this transformation process – and to promoting the likelihood that Veterans will seek these services!

Finally, mental health facility design should place important emphasis on the design *process*, particularly the membership and functioning of the design team, as this can significantly impact the final design, its functionality, and its adoption by staff. Specifically, it is strongly recommended that the design process include an interdisciplinary design team that involves active participation from clinical staff, as well as staff and external consultants from architecture, engineering, interior design, and other disciplines. Such an interdisciplinary approach allows for a truly dynamic process that can enhance creativity and problem-solving and promote usability, satisfaction, and acceptance with the designed space. In addition, including Veteran patient input and feedback in the design process through focus groups, interviews, and other methods is recommended.

We hope this Design Guide serves as a useful planning tool to those embarking on new design and major renovation projects. Through the development and application of this Design Guide and the creative vision and efforts of local design teams, VA can achieve a new paradigm for mental health design and, in so doing, further promote our patients' journeys toward recovery.

Bradley E. Karlin, PhD
National Mental Health Director,
Psychotherapy and Psychogeriatrics
Office of Mental Health Services

Foreword

The goal of the Design Guide is to facilitate the design process and to ensure excellent quality, effectiveness, efficiency, and consistency of VA facilities while controlling construction and operating costs. This document is intended to be used as a guide and to supplement VA Space Planning Criteria, technical criteria, and other related VHA policies for mental health services in VA Medical Centers and Clinics. Use of this Design Guide does not preclude the need for a functional and physical program for each specific project. It is the responsibility of the Project Architect/ Engineer to develop a complete and accurate project design that best meets the users' needs, applicable standards, and code requirements.

The material contained in this Mental Health Design Guide is the culmination of a partnering effort within the Department of Veterans Affairs by the Veterans Health Administration and the Office of Construction and Facilities Management to enable the transformation of the environment of care to a patient- and family-centered focus and culture. We would like to give special thanks to VHA's Dr. Bradley Karlin for his tireless efforts toward the creation of this Design Guide, which would not have been possible without his and his colleagues' dedication.

Lloyd H. Siegel, FAIA
Director
Strategic Management Office

1.2. Acknowledgements

The following individuals with the Department of Veterans Affairs are those whose guidance, insight, advice and expertise made this Mental Health Design Guide possible:

Office of Construction & Facilities Management (00CFM)

Lloyd H. Siegel, FAIA
Director Strategic Management Office

Kurt D. Knight, PE
Chief Director, Facilities Quality Services

Dennis Hancher, RA
Project Manager, Architect, VACO

Gary Fischer, AIA
Project Manager

Dennis Sheils
Team Leader, Project Planning & Development Office

Satish Sehgal, PE
General Engineer, Standards Program Manager

Orest Burdiak
Principal Interior Designer

Lam Vu, PE
Electrical Engineer

Lawanda J. Jones
Administrative Assistant

John Wasyluk
Senior Management Analyst

Dan Colagrande
Architect, Consulting Support Service

Office of Mental Health Services

Bradley E. Karlin, PhD
National Mental Health Director, Psychotherapy and Psychogeriatrics

William Van Stone, MD
*Associate Chief Consultant, Psychiatry, Professional Services,
Inpatient/Outpatient Services (Retired)*

Susan McCutcheon, RN, EdD
Director, Family Services, Women's Mental Health and Military Sexual Trauma

Paul Smits, MSW
*Associate Chief Consultant, Homeless and Residential Rehabilitation and
Treatment Programs (Retired)*

Laurent S. Lehmann, MD
*National Mental Health Director, Mental Health Disaster Response / Post
Deployment Activities / PTSD*

John-Paul Allen, PhD
National Mental Health Director, Addictive Disorders

Lisa Pape, LISW
*National Mental Health Director, Homeless and Residential Rehabilitation &
Treatment Services*

Daniel O'Brien-Mazza, MS
Director, Peer Support Services

VA National Center for Patient Safety

Peter Mills, PhD, MS
Director, Field Office

VA Primary Care – Mental Health Integration

Edward P. Post, MD, PhD
National Director

VA Care Coordination Services

John Peters
Telehealth Program Analyst

Women Veterans Health Strategic Health Care Group

Patricia M. Hayes, PhD
Chief Consultant

Mary Ann Woodward-Smith, RN, MSN, PMHCS, BC
Deputy Field Director

VA Office of Nursing Services

Suzanne Thorne-Odem RN, MS
Mental Health Clinical Nurse Advisor

VA Nutrition & Food Services

Ellen Bosley, MBA, MS, RD
National Director, Food Services

Mary Pat Lynch
Food Service Consultant

VA Environmental Services

Aubrey Weekes
Director, Environmental Services

VA Office of Academic Affiliations

Robert A. Zeiss, PhD
Director, Associated Health Education

Prime Consultant

HDR Architecture, Inc.

James R. Langlois, AIA
Principal-In-Charge

Charles Reed, AIA
Senior Project Manager

April McKinley, RN
Behavioral Healthcare Consulting

Julian Jones, AIA
Healthcare Planning

Ronald Villasante
Senior Project Manager

Jeff Getty, AIA
Healthcare Designer

Laura Lycan
Healthcare Operations Planner

Keith Strunk
Senior Mechanical Engineer

Tracy Atkinson, AIA
Project Architect

Allen Myers
Administrative Assistant

Peer Review Team

The Design Partnership LLP

Christie Coffin
Senior Architect/Planner

Lisa Bruce
Project Manager

Neval Javed
Designer

1.3. Design Guide Introduction

The Mental Health Design Guide is intended to be a graphic consolidation of new and existing Department of Veterans Affairs standards and criteria. It contains data from the following sources:

1. Standards and Criteria Sources
 - a. Master Construction Specifications PG-18-1
 - b. Construction Standards H-18-3
 - c. Standard Details PG-18-4
 - d. Equipment Guide List PG-7610
 - e. List of Equipment Symbols PG-18-6
 - f. VHA Space Planning Criteria
 - i. Chapter 110: Mental Health and Behavioral Patient Care Units
 - ii. Chapter 202: Substance Abuse Clinic
 - iii. Chapter 260: Mental Health Clinic
 - iv. Chapter 261: Day Treatment (renamed “Psychosocial Rehabilitation and Recovery Center” - (PRRC))
 - v. Chapter 272: Psychology Service
 - vi. Chapter 312: Domiciliary (renamed “Mental Health Residential Rehabilitation Treatment Program” (MH RRTP))
 - g. Barrier-Free Design Handbook H-18-13
 - h. Room Finish and Door Hardware Schedule PG-18-14
 - i. Various Technical Criteria (Design Manuals) pertaining to Architectural, HVAC, Plumbing and Electrical
 - j. Consensus Information from various VA mental health centers

The Design Guide refers to the above-mentioned sources when data are either too detailed or too broad to be included in this guide. This Design Guide was developed as a design tool to assist mental health staff and local leadership and design teams in better understanding the choices that designers ask them to make, and to help designers understand the functional requirements necessary for proper operation of center and clinics where Mental Health Services are provided.

The Guide Plates contained in the Design Guide are intended as illustrations of space needs for patients and personnel. Furniture and equipment required for each space is shown along with required minimum clearances. These guide plates are not meant to limit design opportunities. The Design Guide is not meant to be project specific, though the concepts identified in this Design Guide should be employed. While it does contain the vast majority of department/program specific spaces required in a mental health facility or clinic, it is not possible to foresee all future requirements. Additionally, this Design Guide does not include every room listed in the VHA Space Planning Criteria.

The project-specific space program is the basis for an individual project design. It is important to note that the guide plates are a generic graphic representation only. Equipment manufacturer's should be consulted at time of design to ensure specific dimensions and utility requirements.

Use of this Design Guide should not supersede the project architect's and project engineer's responsibilities to develop a complete and accurate design that meets the user's needs and all applicable VA design requirements.

1.4. Definitions

Assignable Space	A measurement of space attributable to a distinct function or service including support areas and intradepartmental circulation. Defines Net Square Feet
Circulation Area	Entrances, vestibules, (interdepartmental) corridors, passages, elevators, escalators, stairs, etc; included in gross areas and excluded in net areas.
Community Based Outpatient Center (CBOC)	Services provided at Community Based Outpatient Centers vary widely. Very Large CBOCs serve 10,000 Veterans or more per year. Large CBOCs serve 5,000-10,000 Veterans per year. Mid-size serve 1,500-5,000 Veterans, and small CBOCs serve fewer than 1,500 Veterans per year.
Departmental Gross Square Feet (DGSF)	The sum gross square footage in a department including circulation and wall thicknesses within that department.
Domiciliary	A residential care program for Veterans with a wide range of needs. This program is now referred to under the umbrella of Mental Health Residential Rehabilitation Treatment Programs (MH RRTP)
Evidence-Based Approaches	Facility design and/or operational decisions based on research data that establishes proven benefits for patient care and safety, staff safety, and/or operational efficiency.
Gross Square Feet (GSF)	Total building area measured from the exterior face of the exterior walls. Large floor openings within the footprint are deducted from this total. Shafts and other miscellaneous openings are included in the gross square footage calculation.
Mental Health Residential Rehabilitation Treatment Program (MH RRTP)	<p>MH RRTP provides residential rehabilitative and clinical care to eligible Veterans who have a wide range of problems, illnesses, or rehabilitative care needs which can be medical, psychiatric, vocational, educational or social. A MH RRTP provides 24 hour per day, 7 days per week, (24/7) structured and supportive residential environment as a part of the rehabilitative treatment regime.</p> <p>The term MH RRTP refers to the bed category and includes the following models:</p> <p>Domiciliary Residential Rehabilitation Treatment Programs (DRRTP), Domiciliary Care for Homeless Veterans (DCHV), Psychosocial Residential Rehabilitation Treatment Programs (PRRTP), Substance Abuse Residential Rehabilitation Treatment Programs (SARRTP), PTSD Residential Rehabilitation Treatment Programs (PTSD RRTP), Seriously Mentally Ill Residential Rehabilitation Treatment Programs (SMI-RRTP)</p>
Net Area	The area of rooms or spaces as measured from inside wall to inside wall and assigned to functional use by occupants.

Patient-Centered Approach	Facility design model that focuses care resources around the individual and considers the perspective of the patient. Essential services are near or are brought to the resident as compared to taking the patient to the point of care.
Psychosocial Rehabilitation & Recovery Center (PRRC)	Replaces Day Treatment and Day Hospital units in VA Medical Center. The mission of a PRRC is to provide a center for Veterans challenged with serious mental illness and significant functional impairment to develop skills that will allow them to integrate into meaningful self-determined community roles.
Uniform Federal Accessibility Standards (UFAS)	This document along including the VA supplement for Barrier-Free Design addresses accessibility for VA facilities, some requirements are unique to the VA system.
Veterans Integrated Service Network (VISN)	The VA health care system consists of 21 integrated networks across the US and Puerto Rico that are focused on pooling and aligning resources to better meet local health care needs and provide greater access to care.

1.5. Abbreviations

A	Amps
ABA	Architectural Barriers Act
AC/HR	Air Changes per Hour
ADA	Americans with Disability Act
ADAAG	ADA Accessibility Guidelines
AFF	Above Finished Floor
AHJ	Authority Having Jurisdiction
AIA	American Institute of Architects
ANSI	American National Standards Institute
ALOS	Average Length of Stay
AR	As Required
CARES	Capital Asset Realignment for Enhanced Services
CBOC	Community Based Outpatient Clinic
CFM	Cubic Feet per Minute
CFM	Office of Construction & Facilities Management
DGSF	Departmental Gross Square Footage
EPA	Environmental Protection Agency
FC	Foot Candle
FTEE	Full Time Equivalent Employee
GSF	Gross Square Feet
GSM	Gross Square Meters
HIPAA	Healthcare Insurance Portability and Accountability Act
HP	Horsepower
HPD	Hours per Day
HVAC	Heating, Ventilating and Air Conditioning
IAQ	Indoor Air Quality
IBC	International Building Code
JSN	Joint Section Number

Abbreviations (cont'd)

LB	Pound
LEED	Leadership in Energy and Environmental Design
LUX	Lumen Per Square Meter
MDS	Minimum Data Set
MHICM	Mental Health Intensive Care Management
MH RRTP	Mental Health Residential Rehabilitation Treatment Program
NCPS	VA National Center for Patient Safety
NFPA	National Fire Protection Association
NSF	Net Square Feet
NSM	Net Square Meters
NTS	Not to Scale
OSHA	Occupational Safety and Health Administration
PG	Program Guide
PRRC	Psychosocial Rehabilitation and Recovery Programs
PTSD	Post Traumatic Stress Disorder
RH	Relative Humidity
SF	Square Feet, Square Foot
SMI	Serious Mental Illness
SqM	Square Meters
SUD	Substance Use Disorder
TBI	Traumatic Brain Injury
TIL	Technical Information Library
TJC	The Joint Commission
TV	Television
UBC	Uniform Building Code
UFAS	Uniform Federal Accessibility Standards
UPS	Uninterruptible Power Supply
USGBC	United States Green Building Council
V	Volts
VA	Department of Veterans Affairs

Abbreviations (cont'd)

VACO	Veterans Affairs Central Office
VAFM	Veterans Affairs Facilities Management
VAMC	Veterans Affairs Medical Center
VHA	Veterans Health Administration
VISN	Veterans Integrated Service Network
VSO	Veterans Service Organizations
W	Watts

LOGISTICAL CATEGORIES (LOG CATS)

VV	VA furnished and installed - Medical Care Appropriations
VC	VA furnished and Contractor Installed - Medical Care Appropriations for Equipment and Construction Appropriations for Installation
CC	Contractor Furnished and Installed - Construction Appropriations
CF	Construction Appropriations - VA furnished. Installed by the Department of VA or Contractor

1.6. Legend Of Symbols






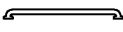







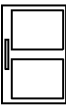


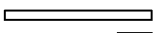
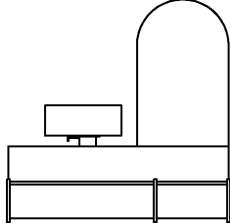

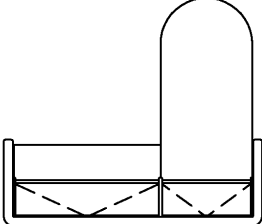

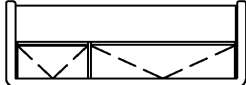

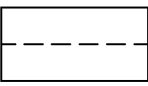

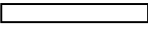

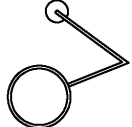






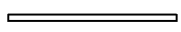


	NURSE CALL DOME LIGHT		PAPER TOWEL DISPENSER A5080
	SINGLE SWITCH		WASTE DISPOSAL UNIT; SHARPS WITH GLOVES DISPENSER A5106
	DIMMER SWITCH		GRAB BAR FOR ACCESSIBLE AND BARIATRIC; VARIABLE SIZE; SEE GUIDE PLATE A5109 / A5110
	RECEPTACLE		ONE WAY OBSERVATION WINDOW A5120
	RECEPTACLE; GFI		WALL HOOK A5145
	RECEPTACLE; QUAD PLEX		ROOM TO ROOM INTERCOM A6330
	TELEVISION CABLE OUTLET		DOUBLE COMPARTMENT SINK CS230
	TELECOM OUTLET A1010		SINGLE COMPARTMENT SINK CS240 & CS250
	SUPPLY DIFFUSER		WALL MOUNTED L-SHAPED PENINSULA WORKSTATION E0063
	SUPPLY DIFFUSER		FREE STANDING L-SHAPED W/PENINSULA WORKSTATION E0078
	RETURN DIFFUSER		FREE STANDING WORKSTATION E0123
	RECESSED CAN LIGHT		48" W COMPUTER WORK SURFACE E0222
	2X2 FLUORESCENT LIGHT		DISPLAY, TACKBOARD & MARKER BOARD WALL MT E0851
	2X4 FLUORESCENT LIGHT		
	CEILING MOUNTED EXAM LIGHT WITH ARM OVER STRETCHER LOCATION		
	TRAY RETURN/WASTE CONTAINER		
	STOVE TOP		
	WALL-MOUNT TELEVISION		
	DESK PHONE A1010 / A1011 / A1015		
	WALL PHONE A1012 / A1014 / A3200		
	MIRROR A1066		
	ACCESSORY MOUNTING RAIL A1132		
	SOAP DISPENSER A5070		
	SOAP DISPENSER, DISPOSABLE A5075		

Figure 1.6.1
Legend of Symbols

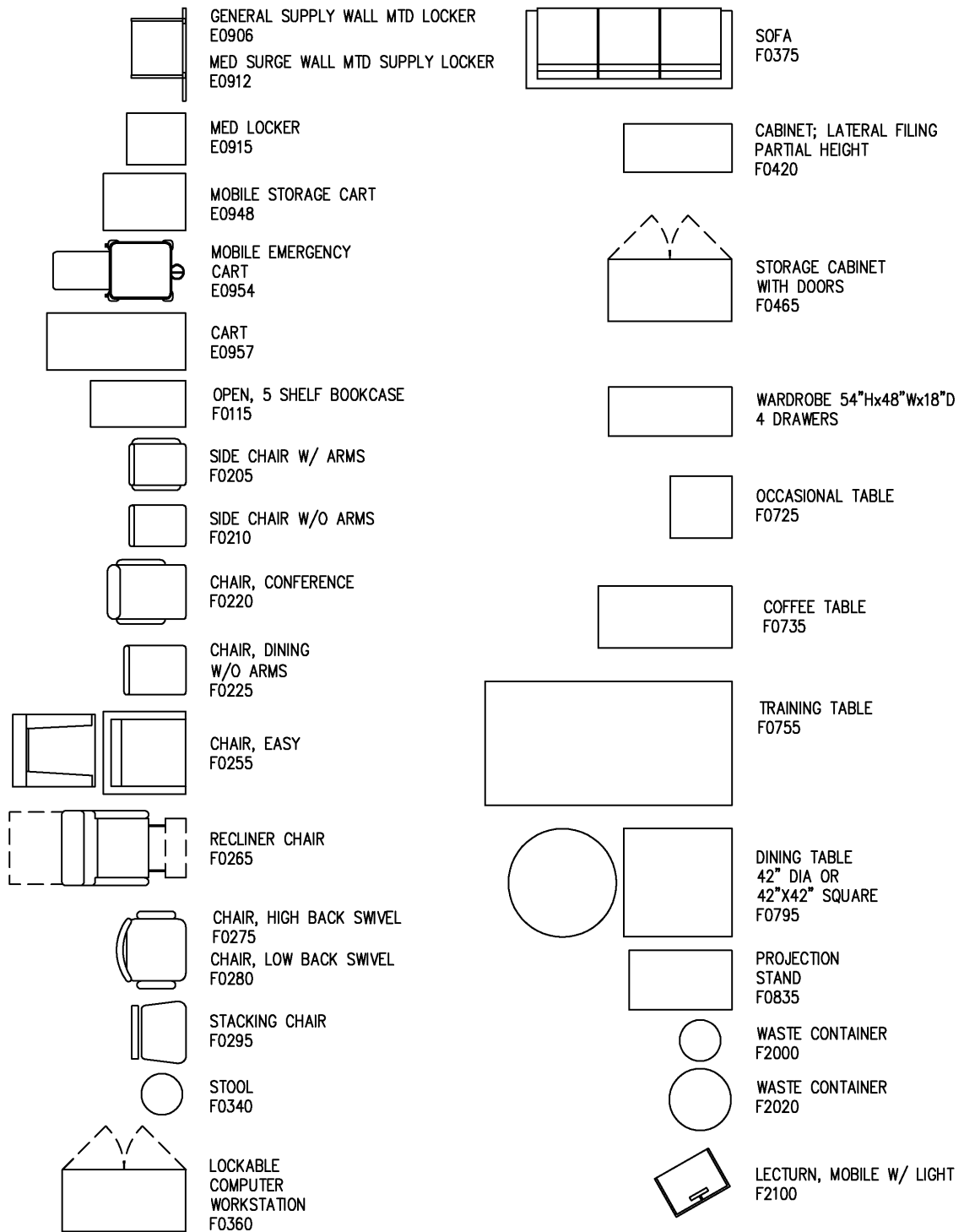


Figure 1.6.2
Legend of Symbols

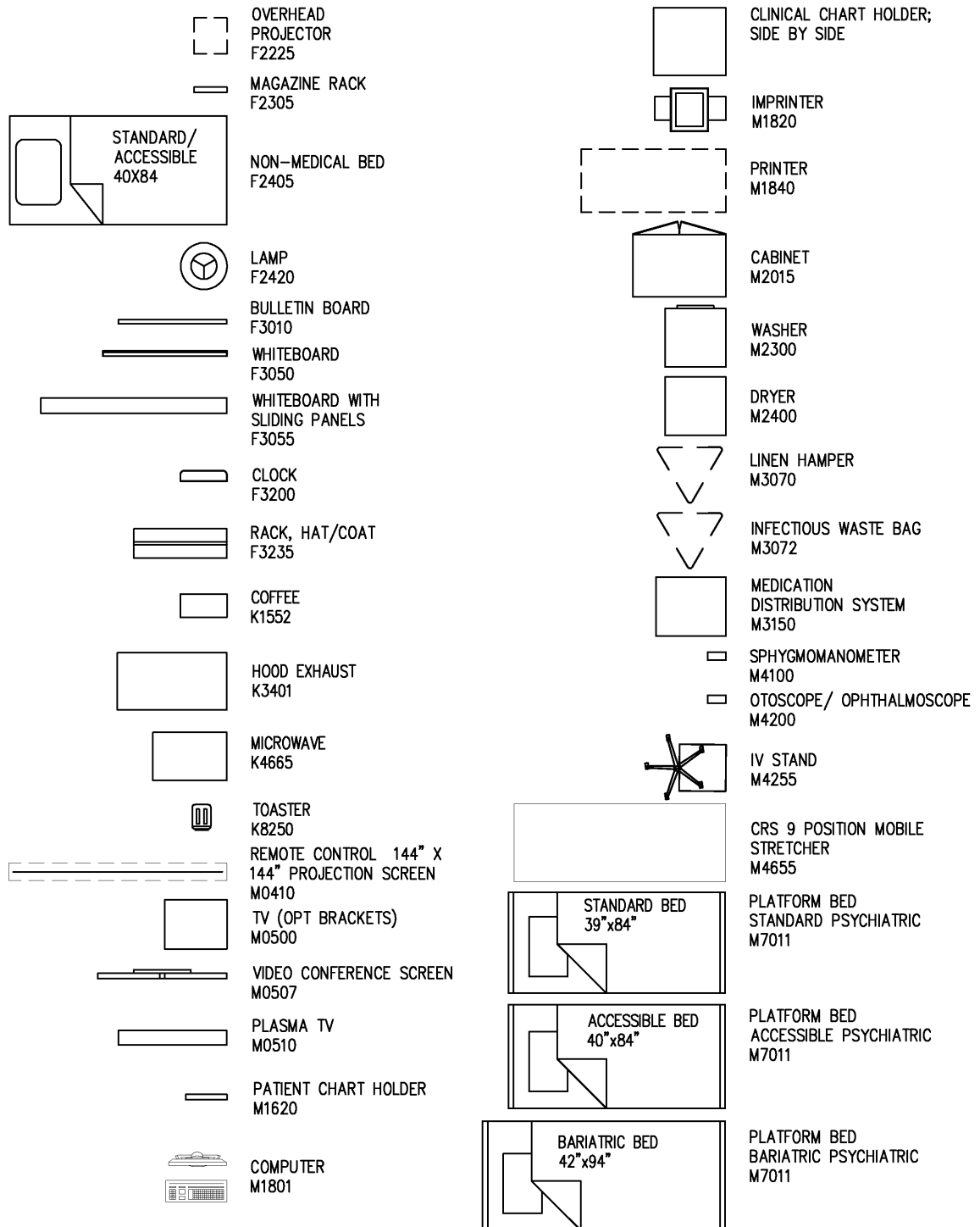


Figure 1.6.3
Legend of Symbols

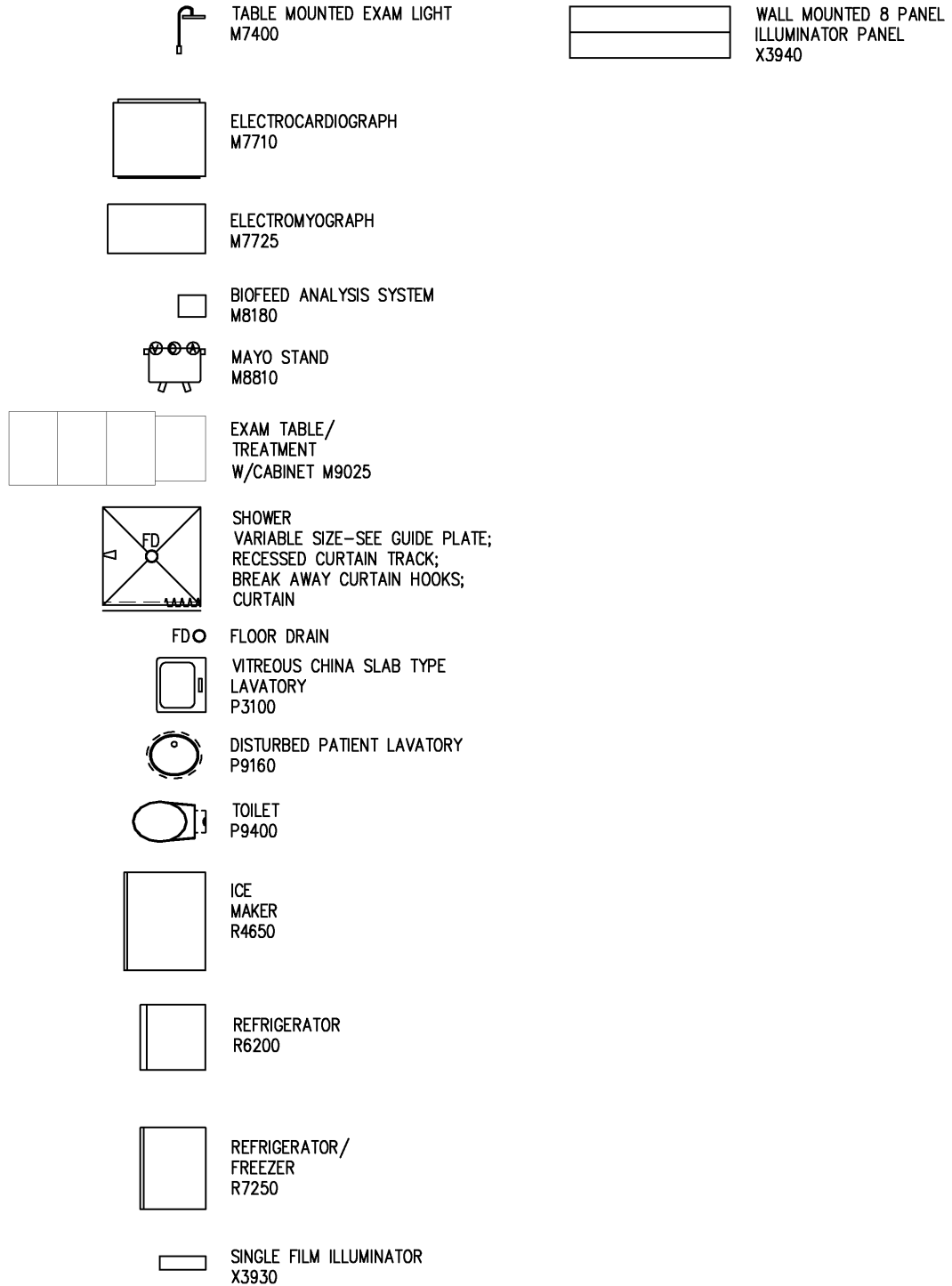


Figure 1.6.4
Legend of Symbols

(This page intentionally left blank)



Department of
Veterans Affairs

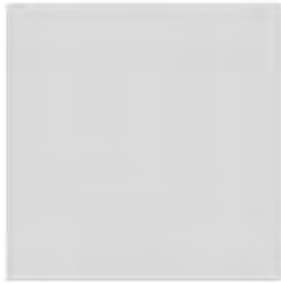
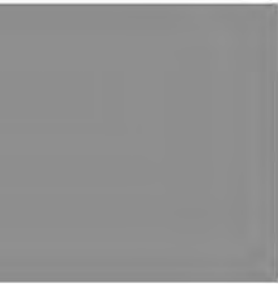
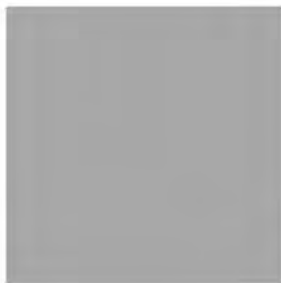
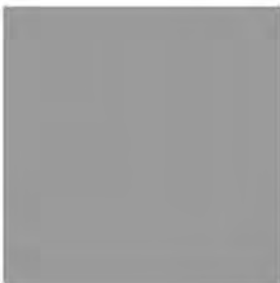


Office of Construction &
Facilities Management

Section 2

GENERAL OPERATIONAL NARRATIVE

MENTAL HEALTH FACILITIES DESIGN GUIDE



2.0. GENERAL OPERATIONAL NARRATIVE

2.1. Operational Summary

The Veterans Health Administration (VHA) operates one of the world's most comprehensive mental health care delivery systems. The VA mental health care continuum covers the full range of mental health problems experienced by Veterans. Access to the appropriate level of care and ongoing continuity of care are vital facility design issues. Mental health services in VHA are offered along a continuum of service settings that include Inpatient, Residential, and Outpatient settings. Within each of these settings, services are provided to promote recovery and individual potential, with an emphasis on evidence-based practices.

Within the inpatient sector, VHA provides a vast array of individualized mental health services, including but not limited to inpatient services provided in general psychiatric units and psychiatric intensive care units. In addition to inpatient services provided on psychiatric units, VHA provides 24-hour, non-acute, residential rehabilitative and clinical care in Mental Health Residential Rehabilitation Treatment Programs (MH RRTPs) to eligible Veterans who have a wide range of problems, illnesses, or rehabilitative care needs.

The outpatient component of the VA mental health care delivery system includes a wide range of specialized mental health treatment settings, including, but not limited to, the Mental Health Clinic, Substance Abuse Clinic, Psychology Service (at many facilities), and Psychosocial Rehabilitation and Recovery Center (PRRC), which promotes recovery in Veterans with serious mental illness and replaces Day Treatment and Day Hospital units in VA Medical Centers. Through efforts to promote innovation in mental health care delivery and enhance service access and quality, mental health services are also increasingly being provided in non-mental health specialty settings. This includes, but is not limited to, Primary Care, Community Living Centers, Spinal Cord Injury Centers, and Blind Rehabilitation Centers. For those Veterans with mental health needs who are also being actively treated for serious medical conditions, mental health services are provided in a medical setting as appropriate. Additionally, VA has integrated mental health services into Community Based Outpatient Clinics.

Some of the most common mental health conditions treated in this continuum of care include:

- Mood disorders, including major depressive disorder;
- Substance use disorders (SUDs);
- Posttraumatic stress disorder (PTSD), conditions related to military sexual trauma (MST), and other trauma-related conditions;

- Other anxiety disorders, such as panic disorder, obsessive-compulsive disorder, and specific phobias; and
- Serious mental illness (SMI), including bipolar disorder, schizophrenia-related disorders, and other psychotic disorders.

Veterans presenting for mental health treatment often have multiple mental health, as well as physical health, problems.

There is currently an important focus on meeting the mental health needs of an increasing number of younger Veterans returning from Iraq and Afghanistan that are seeking care in VHA. At the same time, however, current enhancements to mental health care services have been developed with the goal of improving access and care for older Veterans, as well, so that Veterans of all combat eras have timely access to a full continuum of effective mental health services. Currently, the average age of VA patients is approximately 60. Moreover, it is important to note that there are an increasing number of female patients receiving care in VHA.

Accordingly, sensitivity to gender-specific and geriatric issues is very important in terms of both therapeutic programming and facility design. Furthermore, it can be contraindicated to treat some patient populations together in the same physical space (e.g., older patients with dementia or severe depression and younger patients with traumatic brain injury (TBI)). Appropriate accommodations for the diversity of patients and their clinical needs, privacy, dignity and security are a high priority. Specific considerations for special populations are provided in this Design Guide. It is strongly recommended that the Women Veterans Program Manager be involved in the design process.

Specific subgroups of mental health patients that can require specific facility and/or operational accommodations include:

- Older Veterans
- Women Veterans
- Veterans with physical disabilities (e.g., spinal cord injuries)
- Veterans with traumatic brain injury (TBI)
- Bariatric patients
- Airborne infection isolation patients

Some Veterans who require more acute mental health services may not be best treated in an inpatient mental health setting due to serious physical mobility limitations and/or co-morbid medical conditions that require highly skilled medical care. These patients should typically be treated in an appropriate inpatient medical unit with mental health services and appropriate accommodations provided in that setting. Care for patients with medical or physical needs is provided within an inpatient mental health unit only to the extent that patient

safety and overall care is not compromised. For example, grab bars in patient bathrooms rooms with a solid panel between the bar and the wall to prevent them from being used as an anchor point should be available to help support Veterans with mild-to-moderate physical limitations. This patient safety feature is essential in an inpatient mental health unit but cannot be used by all disabled patients. Additionally, medical gases, patient lifts, and other medical equipment and devices that may be required for a patient's care also create a patient safety risk within an inpatient mental health unit. When the inpatient mental health design features detailed in this Design Guide are not adequate for the accommodation or treatment of an inpatient, that patient should generally be treated elsewhere.

A central theme of this Design Guide is that creating a physical, interpersonal, and psychological environment that supports the therapeutic milieu is essential to the recovery process. Recovery is promoted not only in the therapeutic program, but also in the facility design. Patient care areas that incorporate natural light, access to exterior environments, color, art, pleasant furnishings, and other components of a warm environment have been shown to advance healing and recovery. Additionally, promoting positive socialization and engagement, while also providing opportunities for controlling one's social environment, is critical to successful treatment and the recovery process.

Mental health care delivery in VHA is often delivered within an interdisciplinary team context, where team members interact and work together as partners in the treatment process. Interdisciplinary treatment teams may be comprised of mental health professionals from the core mental health disciplines (psychiatry, psychology, social work, nursing), as well as other professions. These professionals include, but are not limited to:

- Psychiatrists
- Psychologists
- Social Workers
- Advance Practice Nurses/Nurse Practitioners
- Registered Nurses
- Licensed Practical Nurses
- Licensed Vocational Nurses
- Dieticians
- Chaplains
- Vocational Rehabilitation Specialists
- Rehabilitation Technicians
- Recreational Therapists
- Peer Support Technicians

The treatment team offers therapeutic programming in a variety of settings throughout the levels of care in order to accommodate specific patient needs as well as support the patient population as a whole. Private treatment areas for

individual therapy, family therapy, group rooms, day/community areas and family visiting areas are all important in the treatment process. In addition, having “off-stage” areas for staff to support their duties and responsibilities is also important.

2.2. Guiding Principles

Mental health care in VHA is provided in a treatment culture that is built around the concept of recovery. In the recovery-oriented treatment culture, emphasis is placed on maximizing hope, meaning, and individual potential. VHA is committed to promoting recovery in all patients, including those with even the most severe mental illnesses. Mental health services in VHA reflect and advance the following fundamental principles of recovery.

Ten Fundamental Components of Recovery:

- 1. Self-direction**
- 2. Individualized and person-centered**
- 3. Empowerment**
- 4. Holistic**
- 5. Achievement of full potential**
- 6. Strength-based**
- 7. Peer support**
- 8. Respect**
- 9. Responsibility**
- 10. Hope**

Source: VHA Handbook 1160.01, Uniform Mental Health Services in VA Medical Centers and Clinics, September 11, 2008; National Consensus Statement on Mental Health Recovery (found at: <http://mentalhealth.samhsa.gov/publications/allpubs/sma05-4129/>)

This Mental Health Design Guide was developed based on the premise that the environment of care can significantly impact the recovery process – either in a facilitatory or inhibitory fashion. The specific principles and approaches emphasized in this Guide are based on a recovery-oriented, evidence-based design paradigm. Specific guiding principles for the development of this Design Guide and related attributes are summarized below:

Principle #1: Mental health services should be recovery-oriented

- **Patient and family-centered**
- **Rehabilitation/recovery-focused**
- **Evidence-based**
- **Emphasis on community reintegration**

Principle #2: Mental health services should be provided in a therapeutically enriching environment

- **Home-like**
- **Familiarity**

- Visual and physical access to nature to promote healing
- Patient autonomy, respect, and privacy

Principle #3: Mental health services should be provided in a safe and secure environment

- Minimize potential physical hazards
- Enhance staff visibility and engagement with patients
- Use of abuse-resistant materials, furnishings, and fixtures
- Incorporate safety-promoting technologies (e.g., personal duress alarms, pressure sensitive door head alarms)

Principle #4: Mental health services should be integrated and coordinated

- Promote collaboration among care providers
- To the largest extent practical, treat the patient for multiple diagnosis in the same setting
- Use of technologies to promote continuity of care

Principle #5: Mental health services should be provided in settings that respect and can accommodate a diverse range of patient populations and care needs

- Provide appropriate accommodations for specific patient groups
- Promote safety, privacy, and dignity of female Veterans
- Provide separation within inpatient units or provide distinct units, where necessary

2.3. Operational / Planning Recommendations

2.3.1 General Trends in Mental Health Design

Bring the services to the patients and maximize therapeutic opportunities

Consistent with the goal of recovery and the desire to treat patients in the least restrictive setting possible, there is a general trend for patients in inpatient mental health settings to have shorter lengths of stays. To maximize treatment services, patient engagement, and interdisciplinary care processes in an inpatient setting, there should be adequate treatment, therapy, and staff space on the inpatient unit, thereby minimizing movement and separation of the patient and service provider.

Create Non-Institutional Treatment Environment

Creating a more familiar, therapeutic environment helps reinforce the recovery focus of the program and reduce institutional stigma often associated with mental health treatment facilities. To this end, interior and exterior features of mental health facilities are increasingly home-like in appearance and feel. Inpatient and residential facilities, where feasible, are single story or village-like, with multiple exterior courtyards bringing in more natural light and views of nature. The interior design embodies safe, residential components, with improved aesthetics, ventilation, and noise control. Traditional inpatient environments with enclosed areas and physical barriers between staff and patients, such as enclosed nursing stations, are typically not needed or favored in most inpatient facilities today and are being replaced with open concept nursing stations of reduced size that blend into a more open environment and promote normal social interaction and engagement.

Private Patient Rooms and Bathrooms

Many inpatient mental health facilities in the private sector are moving toward having exclusively, or primarily, single occupancy rooms. An inpatient facility with all private patient rooms allows more patient assignment flexibility, enhances patient privacy, and reduces disruptions and incidents related to a shared patient bedroom. Single occupancy patient rooms have the benefit of being more private and having less noise, which may be agitating to some patients and can disturb sleep.

In VHA, double occupancy rooms may be desirable for some patients for social or clinical reasons. The common military service background and the longer average length of stay in some VA inpatient facilities support having some double occupancy rooms in inpatient units. Based on discussions with VA mental health staff and contemporary approaches to inpatient mental health facility design in other public and private mental health care systems, it is recommended to

provide approximately 50% of the beds (25% of the total rooms) in an inpatient unit in double occupancy rooms.

Flexible Census Units

This trend is based on the inclusion of “flex rooms”, patient rooms between two units that can be “given” over to the other unit when a change in census occurs. Therefore, the facility is not locked into a 10 or 12 bed unit concept, but can be eight or even 14 without modification to the plan.

This flex wing concept is useful in a VA inpatient unit as they house a range of patient types. The flex wing may be used to house women or frail patients to separate them from younger, male patients.

Mall Treatment and Neighborhood Concepts

To reinforce the goal of normalizing a patient’s experience, “treatment malls” are being developed in some mental health facilities as a part of the daily programming routine for patients. This destination event promotes independence, life skills building, and appropriate behavior modeling. These “malls” are wider than average corridors with abundant natural light and ideally access to an exterior courtyard. There are attractive waiting alcoves for patient families and the full range of outpatient services and clinics are accessed directly off of this mall.

On Stage and Off Stage Design

The “on-stage, off-stage” concept separates, where possible, patient pathways (“on-stage”) throughout the facility from materials management, food service and clean materials delivery within the facility, as well as staff support areas (“off-stage”). This minimizes noise, disruption and distractions in areas actively used by patients.

Use of Technology

Technology in mental health facilities provides benefits in enhancing security, communications, and patient care. Security enhancements include: door control, inventory control, and facility monitoring.

Communication enhancements include: access to continuously updated patient treatment documentation by all appropriate members of a patient’s interdisciplinary care team.

A key component of the VA’s patient care includes “telemental health.” “Tele-mental health” refers to remote visual/audio communication between the patient and care team professionals. Individual consultations may utilize personal

computers with a camera. This technology is important to ensuring continuity of care for those patients living in remote or rural areas. All inpatient, residential, and outpatient facilities should have audio- and video-conferencing capability for both individual and group use. Appropriate band-width capability should be available at the facility to allow for maximal use of telemental health care.

Furthermore, computer access is an important component of recovery and rehabilitation and should be incorporated into the design of inpatient, residential, and appropriate outpatient (e.g., PRRC) mental health facilities.

2.4. Design Recommendations

2.4.1 Flexibility

The design of a mental health facility needs to respond to changing workloads, care objectives, and technologies, such as wireless technologies for staff.

- Spaces should be universally designed to accommodate a range of related functions.
- Standardization of unit layouts should be developed to reduce care team orientation to different units and to streamline maintenance of each unit.
- Group spaces in particular need to be designed and grouped to accommodate a range of functions and to accommodate change if possible.

2.4.2 Efficiency

- Support spaces, such as storage and utility rooms, should be designed to be shared where possible to reduce the overall need for space.
- Minimize unnecessary travel distances for nursing staff to use support space and to reach patient rooms in an inpatient setting. Place most frequently used support areas closest to the central nursing area.

2.4.3 Patient Needs

Patient and resident dignity, respect for individuality, and privacy should be maintained without compromising the operational realities of close observation, safety, and security. Patient and resident vulnerability to stress from noise, lack of privacy, poor or inadequate lighting, ventilation and other causes, and the subsequent harmful effect on well being, are well-known and documented

A key architectural objective should be to reduce emphasis on the institutional aspects of care and to surround the patient with furniture, furnishings, and fixtures that are appropriate from a safety standpoint but are more residential in appearance. Proper planning and design should appeal to the spirit and sensibilities of both patients and care providers. A spirit of community should be encouraged. Mental health facilities should be environments of healing that allow the building itself to be part of the therapeutic setting and process. The technical requirements to operate the building should be unobtrusive and integrated in a manner to support this concept.

2.4.4 Risk Reduction

The following facility detailing, planning, and design concepts should be integrated into the project to reduce the following risks in mental health facilities:

Eloperments:

1. Allowing one way in and out of congregate areas, as allowed by code.
2. Courtyards instead of fenced outdoor areas.
3. Electronic door controls for emergency egress as allowed by code.
4. Simple circulation with no blind spots.
5. Casual observation (visibility from staff offices and work areas that are not directly responsible for observing patients)

Patient Behavioral Incidents

1. Visibility
2. Specify products for the facility that can not be used as a weapon or used in a suicide attempt.
3. Design appropriate abuse resistance in areas where patients are left alone for periods of time.
4. Integrate technology to assist in observing and maintaining security in areas not readily visible to staff.
5. Equipment, carts, and other supplies should be adequately stored in locked rooms. Alcoves should not be used for storing or parking of equipment, carts and assistive devices in corridors and other unsecured areas.

Reducing Patient/Staff Injuries:

1. Appropriate accommodations for disabled and bariatric patients.
2. Eliminate balconies, openings, etc. that would allow a patient to jump from an elevated platform.
3. Patient rooms and other areas where patient is alone have enough abuse resistance to allow time for an appropriate response team to arrive before a patient harms themselves or is able to exit the space.

Reducing Patient and Staff Stress:

1. Natural light in staff/patient areas.
2. Noise control.
3. Open layout, with no unnecessary barriers between staff and patient.
4. Space for both patients and staff is designed so neither feels trapped or vulnerable; overcrowding is avoided.
5. Attractive views of the exterior.
6. Use of natural materials, a soothing color palette and residential character in the interior design of the facility.
7. Familiar and healing environments.
8. Patient and staff areas that allow for relaxation and controlling one's social environment (e.g., quiet rooms, staff lounges, secure outdoor space).

NOTE: In addition to architectural design principles and strategies, this Design Guide includes information about appropriate furnishings, equipment, and other items. More detailed guidance and information on such specific items has been developed by the VA Mental Health Environment of Care (EOC) Design Work Group. Design teams and interior designers are strongly encouraged to access this guidance, which includes specific product examples.



Department of
Veterans Affairs



Office of Construction &
Facilities Management

Section 3

PLANNING AND DESIGN CRITERIA

MENTAL HEALTH FACILITIES DESIGN GUIDE



3.0 PLANNING AND DESIGN CRITERIA

3.1 Introduction

This chapter identifies key planning and design criteria and strategies for inpatient, residential, and outpatient mental health settings in VHA. These criteria and design strategies should be incorporated in all new construction and major renovation projects of mental health facilities in VHA.

Although the focus of this Design Guide is on new construction and major renovation projects, several elements identified in this Design Guide can be easily and relatively inexpensively implemented into existing mental health facilities that can have a significant impact on the physical environment and on the reactions of patients, family members, and staff. This includes the use of wood-tone vinyl flooring, wall color, artwork, and attractive and safe furnishings, which are described in more detail below and in referenced companion documents. Facilities are strongly encouraged to incorporate these elements into existing designs.

The specific design criteria and approaches described in this chapter emphasize establishing healing and patient-centered environments of care, while promoting the functional and operational missions of the facility.

Patient and staff safety and security, including physical safety and security requirements, infection control, and fall prevention, are also integral components of mental health facility design. However, these approaches should not and need not detract from the healing environment. Specific strategies and design approaches are provided for promoting safety and security in the environment of care without compromising the healing and welcoming quality of the environment.

Additional VA documents and guidance addressing specific safety and security requirements for inpatient mental health facilities that designers should review are:

VA Mental Health Environment of Care Checklist (11/2009)

VHA Patient Safety Alerts and Advisories
VHA National Center for Patient Safety
<http://www.patientsafety.gov/alerts.html>

VA Mental Health Environment of Care Design Work Group Guidance –
Guidance on appropriate furnishings, equipment, and other items for inpatient mental health units

Designers may also wish to consult:

VA Handbook 1330.01 Health Care Services for Women Veterans (5/2010)
http://www1.va.gov/vhapublications/ViewPublication.asp?pub_ID=2246

Design Guide for the Built Environment of Behavioral Health Facilities, distributed by the National Association of Psychiatric Health Systems
<http://www.naphs.org>.

3.2 Inpatient Mental Health Units

3.2.1 Introduction

Inpatient mental health units will typically be located within existing VA Medical Centers and within relatively close proximity to the Emergency Department. This allows convenient access for patients, families, and staff and facilitates transport and the ability to treat co-morbid medical issues. Where feasible, inpatient mental health units may be located in a distinct facility that is part of a VA Medical Center campus. The information contained in this Design Guide is intended to be applied to locked inpatient mental health facilities, with the goals of promoting safe and recovery-oriented environments.

Key design concepts for designing inpatient mental health units include:

- Create a non-institutional, home-like environment through careful attention to external and internal architectural features and interior design elements.
- Layout should incorporate an open and bright design.
- Unit configuration should be based on a pod-like design and should be absent of long corridors in order to promote social engagement and interaction with staff and provide for a more domestic and less institutional feel.
- Layout should be free of blind corners. Portions of the unit, such as the office suite, should be designed to be closed off after hours to reduce the amount of area within the unit required to be supervised by staff.
- Provide ample visual and physical access to nature, which promotes healing. Provide attractive, secure outdoor spaces directly off the unit. In addition to ample courtyard space for patient activities, consideration should be given to incorporating healing gardens. Indoor patient activity areas should have access to natural light and views, as well as appropriate acoustic control.
- Incorporate wall color, trim, accent colors, and securely-anchored artwork in common areas and patient rooms.
- Minimize the potential for furnishings, fixtures, and equipment within the unit to be used as a weapon or anchor point for hanging.
- Develop multiple patient room clusters within the unit to allow for separation of different patient sub-groups.

- The nursing station should blend in both in scope and design with the therapeutic environment. The nursing station should have direct visibility of all patient wings and activity areas. The station itself should be designed to allow for informal interaction with patients without compromising the confidentiality of patient records.
- Include an identifiable reception area for greeting patients and their families in a lobby area just outside the unit. In addition to functional benefits, a reception area sends a welcoming message to users. Sufficient signage should be placed to direct patients and families to this area.

For additional information and elaboration on principles identified above and throughout this Guide with respect to designing therapeutic, home-like, and safe inpatient mental health units, see:

Karlin, B. E., & Zeiss, R. A. (2006) Environmental and therapeutic issues in psychiatric hospital design: Toward best practices. *Psychiatric Services*, 57, 1376-1378.

3.2.2 Current Examples

The VA has several new generation mental health inpatient facilities underway either in design or construction. Included in this section is a project that embodies key design and planning criteria referenced in this Design Guide.

The facility shown in Figure 3.2.2.1 is a stand-alone inpatient mental health facility proposed to be located on the VA Palo Alto campus. This aerial view illustrates the preferred design approach for new inpatient mental health facilities. This facility is one-story facility with multiple courtyards that allow for direct patient access.

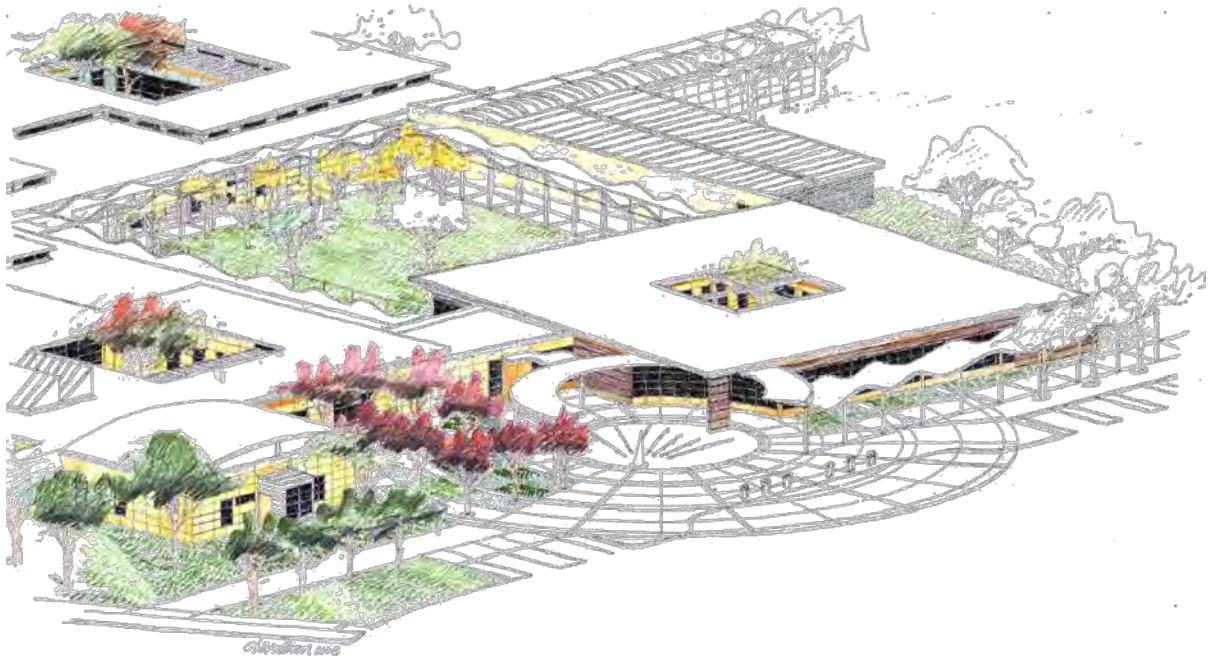


Figure 3.2.2.1
Proposed Inpatient Mental Health Facility
VA Palo Alto
Overall View

Architect: The Design Partnership, LLP

When at all possible, inpatient mental health facilities should be constructed at ground level, incorporating a village-type design. This allows for a more home-like feel and greater visual access to the outdoors. In addition, a single story design allows direct access to and use of designated outdoor areas by patients.

Figure 3.2.2.2 illustrates the plan for the proposed inpatient mental health facility at VA Palo Alto. Facility support and four inpatient units are organized around a large central courtyard. Each inpatient unit has courtyards within the unit as well.

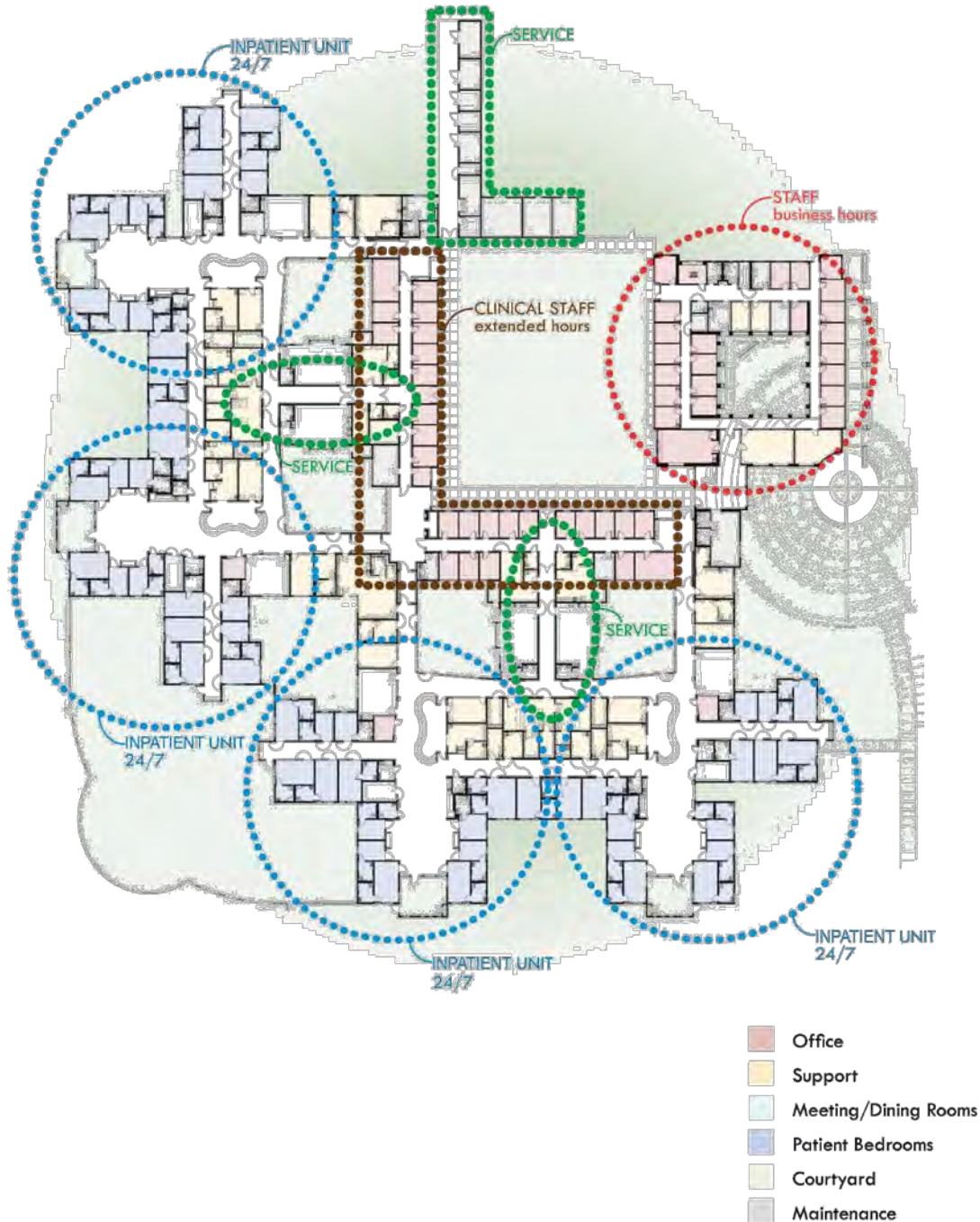


Figure 3.2.2.2
Proposed Inpatient Mental Health Facility
VA Palo Alto
Overall Floor Plan
Architect: The Design Partnership, LLP

A typical inpatient unit for the proposed VA Palo Alto facility is shown in Figure 3.2.2.3. The floor plan incorporates an open, pod-like design, with a residential feel. A central nursing station has visibility down the three patient wings and direct observation of patient activity areas, the entrance to the unit and a central outdoor courtyard.



Figure 3.2.2.3
Proposed Inpatient Mental Health Facility
VA Palo Alto
Typical Inpatient Unit
Architect: The Design Partnership, LLP

One patient room wing has a large open dayroom/activity space directly off of the bedrooms. The second wing acts as a “flex” wing. This unit and the adjacent unit are able to adjust the number of beds in this wing based on patient occupancy at the time.

3.2.3 Inpatient Mental Health Unit Relationship Diagram



Figure 3.2.3

3.2.4 Inpatient Entrance/Reception

A secure vestibule consisting of two interlocking doors at the entrance is required to prevent patient elopement. The design of this entry to the unit should be developed so that the image is welcoming to family and other visitors and the impact of the security provisions is minimized. Ideally, during the daytime, a ward clerk will be adjacent to the entrance to the unit to welcome visitors in addition to performing administrative tasks. A small waiting area should be provided near by for visitors and family to wait before being admitted to the unit. Beyond its functional benefits, the inclusion of designated reception and waiting areas is an important aspect of patient-centered design and creates initial perceptions and expectancies of a welcoming environment and that the patient is valued.

During hours when a reception area is not staffed, an intercom and a security camera by the entrance to the unit should be incorporated to allow visitors to contact the nursing station. The secure entry vestibule should have a small locker area for storing any personal items a visitor may have that are not allowed in the unit. Card readers at the entrance and other access points to the unit should be installed so that authorized staff can enter and exit the unit unassisted. The nursing station should not have the ability to open the entry doors remotely.

3.2.5 Patient Room

General:

A minimum of 20% of the total number of patient bedrooms and bathrooms should be accessible for Veterans with disabilities. This percentage may be increased if the patient profile necessitates it or if the project allows for all patient rooms and bathrooms to be sized initially to accommodate Veterans with disabilities. The VA currently requires 100% of medical patient rooms to be accessible for Veterans with disabilities. ADA guidelines only require 10% of the total number of both medical and mental health patient rooms and bathrooms meet standards for accessibility for patients with disabilities.

Ceiling-mounted patient lifts should not be installed in patient rooms or other areas in inpatient mental health units, as they may present an anchor point threat. Rather, portable lifts should be used and stored when not in use and supervised by an appropriate staff member. Bariatric and disabled patients with severe physical or medical conditions compromising basic living activities should generally be treated in a medical or med-psych setting.

Overall Image:

Figures 3.2.5.1 and 3.2.5.2 illustrate a typical inpatient room.

The inpatient room in Figure 3.2.5.1 illustrates the intent for a typical inpatient room both from an aesthetic and a safety standpoint.

Room features include:

1. Exterior window with integral blinds and laminated glass on interior face.
2. Bathroom door with pressure sensitive alarm at door head, continuous hinge and anti-ligature lever with a magnetic latch.
3. Patient room features such as secured, non-breakable artwork, marker board and area rug are optional features that make the room more homelike with out compromising patient safety.
4. Secure trim, headboard and soothing colors contribute to the residential feel of this room.
5. Built in desk and shelving unit to store patient clothing is both attractive and secure.
6. Wood grain pattern sheet vinyl flooring and molding profile rubber base enhance the residential feel.



Figure 3.2.5.1
Typical Patient Room



Figure 3.2.5.2
Typical Patient Room – Aerial View



Figure 3.2.5.3
Typical Patient Room – Aerial View

Finishes:

Flooring/Base: Sheet vinyl flooring now comes in a range of colors and textures. The wood grain patterns in particular create a more residential feel and are **strongly recommended** for inpatient units. Use of wood-toned vinyl flooring can significantly brighten up the area and enhance the aesthetic environment. Similarly, rubber base manufactures now produce a base that simulates wood base profiles which creates a residential image without sacrificing safety.

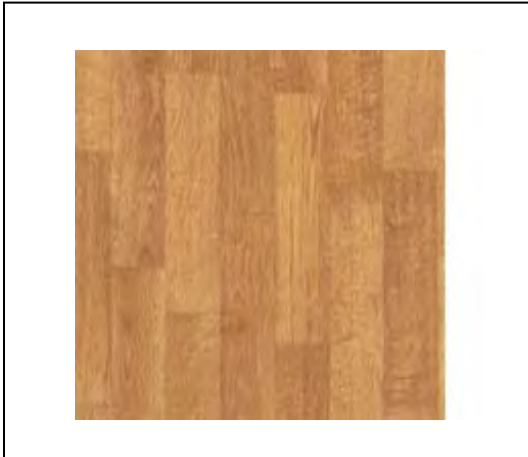


Figure 3.2.5.4: Sheet Vinyl Flooring



Figure 3.2.5.5: Wood Profile Rubber Floor Base

Wall/Ceiling Finishes: Basic wall finishes in the patient rooms should be painted gypsum board. At least one of the walls should have a soothing warm color accent to avoid an all neutral, institutional look. High impact panels with a wood grain texture create the appearance of wood wainscot. This is an excellent feature that can add great warmth throughout the unit and to exterior areas leading to the unit.



Figure 3.2.5.6: Wainscot Paneling

Standard Patient Beds: Beds for mental health inpatients without mobility or other medical needs should consist of a heavy duty platform bed (Fig. 3.2.5.7). Edges should be rounded. Provisions for restraints on the sides of the bed frame may need to be incorporated. Beds for bariatric patients should be similar but larger dimensionally. Electric hospital beds may be substituted for platform beds where appropriate for gero-psychiatric patients and other patients with medical needs requiring this type of bed. All cords on this bed should be less than 12" [304.8 mm] in length to prevent abuse.



Figure 3.2.5.7: Standard Patient Platform Bed

Desk: Desks in patient areas should consist of a simple writing surface. Built in desks with solid surface tops are recommended to eliminate exposed sides. Desk storage should be limited to open shelving on one side.

Desk Chairs: Desk chairs are the primary loose piece of furniture in a patient room. Durable but attractive chairs with arms are recommended for most patient rooms. These chairs should have rounded edges and should not be easily dismantled. They should also be enclosed so that openings do not serve as potential areas for securing a sheet for hanging. In patient rooms, where abuse is a concern, a molded plastic chair may be substituted but is discouraged as the typical type of furniture used in the facility.

Clothing Storage: It is recommended that clothing storage consist of plastic bins stored in open shelving units either built in or furniture. If a wardrobe unit is desired, only spring loaded hooks designed for mental health areas should be utilized in lieu of closet rods and hangers. If wardrobes are used, they should be built in with a gypsum board soffit above to prevent an elevated surface to climb on. Wardrobes should not have doors which could be used as an anchor point.

Marker Boards: Marker Boards should be securely attached in each patient room. The marker boards allow members of the care team to write their name for patient reference as well as list key appointments.

Lighting:

General Illumination: 2'x2' [.6 m x .6 m], 2'x4' [.6 m x 1.21 m] recessed fluorescent fixtures (*Figure 3.2.5.8*) or 9" diameter [228.6 mm] (*Figure 3.2.5.9*) vandal/wet-lensed down-lights may be used with a high strength acrylic lens and flush trim anchored with tamper resistant screws.

Over-bed lighting: Wall mounted over bed lighting, especially for semi-private rooms should be installed above the bed. These fixtures should be designed so they can not be used as an anchor point, should be securely fastened to the wall with tamper resistant screws and have high strength acrylic lenses. *Figure 3.2.5.10* illustrates a custom fixture currently used on a VA facility in Puerto Rico that incorporates both uplighting and downlighting. Correctional type wall mounted lights should not be used for overbed lighting.

Night lighting: Night lighting should be provided in all patient rooms and bathrooms to prevent patient falls and injury and also to allow staff to verify a patient's well being during the night without turning on additional lights.



Figure 3.2.5.8: Standard Recessed Fluorescent Fixture



Figure 3.2.5.9: Wet/Vandal Down-light



Figure 3.2.5.10: Over-bed Light Fixture

Mechanical Supply/Return Diffusers:

Mechanical supply and return diffusers should be located in the ceiling. Diffusers should have small perforations behind the louvers so they are not used as an anchor point (*Figures 3.2.5.11*). Sprinklers should be vandal-resistant and not able to be used as an anchor point (*Figure 3.2.5.12*).



Figure 3.2.5.11: Typical Secure Diffuser



Figure 3.2.5.12: Secure Sprinkler Head

Exterior Windows:

Exterior windows in patient rooms shall be heavy gauge commercial units with insulated double glazing. Patient bedroom windows are required by VA standards to be operable for emergency ventilation. These windows should be able to be locked with a custodial lock with the custodial wrench located at the nurse's station. Operable window openings should not exceed 4" [101.6 mm] to prevent elopement or to allow an unauthorized visitor into the facility. All exterior windows in patient bedrooms should have integral blinds. The interior face of the glazing should be laminated glass. The glazing thickness and composition should be based on attack rating requirements, as established by NCPS.

Patient Bedroom Doors:

Doors to patient bedrooms should be out-swinging unless existing conditions prevent sufficient egress width in the corridor. In all circumstances though, patient bedroom doors must be able to be opened to the corridor to prevent a patient from barricading themselves in the room.

Patient Bedroom Door Hardware: Hardware used on inpatient bedroom and bathroom doors, and doors in rooms where patients may be left unattended, should follow VA hardware guidelines to prevent this hardware being used as an anchor point.

New anti-ligature door hardware has recently become available on the market (Figure 3.2.5.13). Anti-ligature hardware should be used for patient room doors to prevent tampering or use as an anchor point. The door hinge should be continuous to prevent the hinge from being used as an anchor point.



Figure 3.2.5.13: Anti-Ligature Door Hardware



Figure 3.2.5.14: Manual Patient Room Lock – Patient Side

3.2.6 Patient Bathroom

The inpatient bathroom design is one of the biggest design challenges within an inpatient mental health unit. The bathroom should present itself as a normal environment, respecting patient privacy and dignity, with important provisions to maintain patient safety.

Bathroom Floors: 2" x 2" [50.8 mm x 50.8 mm] ceramic tile is recommended for the floor of the bathroom for its superior slip resistance. It is not recommended to be used on the walls where it can be more easily dislodged and abused. A shower drain and a bathroom floor drain is recommended in applications where only a small slab depression (2" [50.8 mm] or less) to slope the floor to the drain can be achieved. Where a slab depression in the bathroom area of 4" [101.6 mm] or greater can be achieved, sloping the entire bathroom floor to the shower drain is the preferred method. In this instance, the shower floor would also be ceramic tile, not the solid surface shower pan shown in this section.

Bathroom Doors: While a door from the patient room to the bathroom is essential for privacy, this door can be the most likely room feature to be used as an anchor point. Listed below are three options, under consideration by VA that an individual facility may consider.

Option 1: Door-Top Pressure Sensitive Alarm: This option allows a standard door to be installed in inpatient rooms. A sensor either mounted on the door top or within the door frame, signals the nursing station if weight is applied to the door. This technology is evolving, and experience to date with this option has been limited. Designers should reference the VA's Patient Safety Alerts (<http://www.patientsafety.gov/alerts.html>) for specific products that have been evaluated by VA.



Figure 3.2.6.1: Door Top Pressure Sensitive Alarm



Figure 3.2.6.2: Door Top Pressure Sensitive Alarm



Figure 3.2.6.3: Hinge Detail

Option 2: Out-Swinging Door with Sloped Top:

The second option, currently installed in several VA inpatient mental health units, utilizes a standard swinging door with the top of the door cut at a 30 degree angle or greater to prevent the top of the door being used as an anchor point.

This modified door is not as visually appealing and home-like as a straight edge door and provides more limited privacy. Figure 3.2.6.5 shows the door cut at an angle. Figure 3.2.6.6 shows a 3” [76.2 mm] gap between the door and frame, which is critical with this door to prevent the latch side of the door from being used as an anchor point.



Figure 3.2.6.4: Out-swinging Door with Sloped Top

As with Option 1, the bathroom door should swing out into the patient room, the door hinge should be continuous, and the door hardware should be a lever type with no return for use as an anchor point. The door latch should release when attempted to be used as an anchor point.



Figure 3.2.6.5: Sloped Patient Door Detail

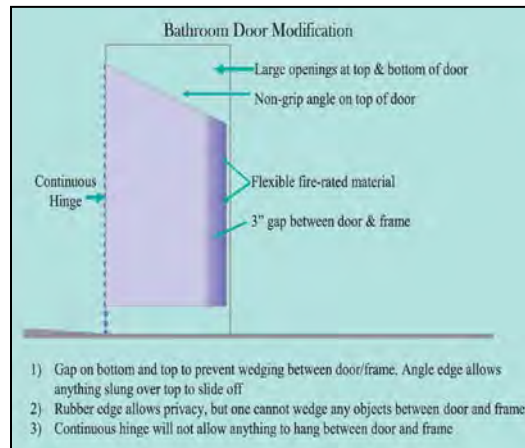


Figure 3.2.6.6: Sloped Door Elevation
TJC – Environment of Care News, 7/05

Option 3: Sliding Door: A third option for a patient bathroom door is a sliding door. This option requires the top sliding track be inset within the wall and have a receiving wall on the patient room side. A pocket door installation is not recommended. With this option, the top of the door cannot be accessed to use as an anchor point. This door also has the advantage of maintaining privacy and having visual appeal. A potential disadvantage to this option is that use of a track on the floor may present an infection control concern, though this may be effectively managed and may not present a major issue. Use without a track is not recommended, as this may provide the potential for the door to be kicked out by a patient. The sliding door option may not be appropriate for patients with limited upper body strength.

This option has appeal though has not yet been evaluated by VA for use in this context; it is currently being evaluated for use in inpatient mental health settings by some facilities. Designers and facility staff should check the VA Patient Safety Alerts (<http://www.patientsafety.gov/alerts.html>) website for updated information about this option.



Figure 3.2.6.7: Sliding Door

Toilets: Toilets in patient rooms should not have any exposed piping. As defined in the plumbing section, controls should be utilized to prevent excessive flushing and flooding. To maintain a normalized environment, porcelain toilets with fixed seats are recommended with push-button flush actuators. Stainless steel toilets should only be used in seclusion rooms.



Figure 3.2.6.8: Porcelain Toilet Option

Lavatory: Lavatories should be solid surface material with an integral sink. All piping below the sink should be concealed behind a panel fastened with tamper-resistant screws, accessible only to maintenance staff. Faucets should be simple sensor activated with preset temperature mix of 110° F [43.34° C].



Figure 3.2.6.9: Bowl / Faucet

Shower:

Shower Controls: Shower controls should be recessed stainless steel panels with no part of the assembly able to be used as an anchor point. Accessible showers should have a dual-head in accessible rooms (*Figure 3.2.6.10*).

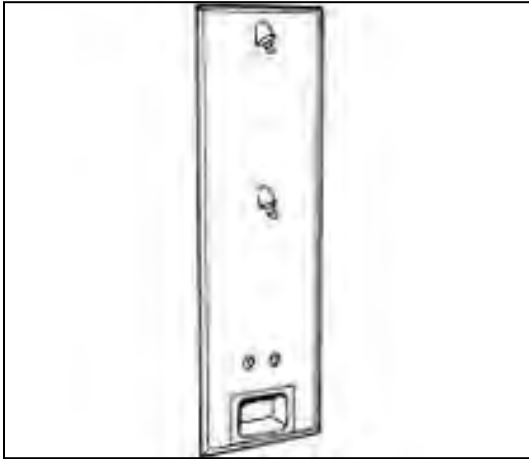


Figure 3.2.6.10: Standard Shower Control Panel

Finishes: Solid surface wall panels and solid surface shower pans are recommended for patient bathrooms. The material is attractive yet durable.



Figure 3.2.6.11: Solid Surface Shower Pan



Figure 3.2.6.12: Solid Surface Shower Wall Panels

Shower Curtains: Showers should be designed in new and renovated construction to prevent the need for shower curtains. However, in some conditions, shower curtains may be necessary to prevent water from spilling on the patient bathroom floor and creating a slip hazard. The shower curtain should be suspended from a recessed track with plastic clips or Velcro tabs that will allow the curtain to collapse, with less than 4 lbs [1.81kg] of weight applied.

Bathroom Accessories:

Mirror: Mirrors in patient bathrooms should be reflective polycarbonate with a stainless steel frame firmly anchored to the wall. No shelf should be part of this frame assembly (*Figure 3.2.6.13*).

Toilet Paper Dispenser: A safety toilet paper dispenser consisting of a soft spindle should be used in all patient bathrooms. Recessed toilet paper holders without a spindle should not be used for infection control concerns (*Figure 3.2.6.14*).

Grab Bars: Grab bars, as required for accessible rooms, should be fixed to the wall with a welded horizontal plate on the bottom of the bar to prevent using these bars as anchor points. Because of patient safety concerns, swinging grab bars recommended in VA facilities at toilets should not be used (*Figure 3.2.6.15*).

Clothing Hooks: Clothing or towel hooks should be designed to collapse when any weight above 4 lbs [1.81 kg] is applied (*Figure 3.2.6.16*).

Shower/Floor Drains: Drains should be attached with security screws to prevent removal by patients.

Paper Towel Dispenser: Paper towel dispensers in patient bathrooms shall be recessed (*Figure 3.2.6.17*).

Soap Dispensers: Soap dispensers shall be wall-mounted with sloped tops to prevent this fixture from being used as an anchor point. The VA is working with manufacturers to develop a suitable recessed soap dispenser (*Figure 3.2.6.18*).



Figure 3.2.6.13: Safety Mirror



Figure 3.2.6.14: Safety Toilet Paper Dispenser



Figure 3.2.6.15: Safety Grab Bar



Figure 3.2.6.16: Collapsible Clothing Hooks



Figure 3.2.6.17: Recessed Paper Towel Dispenser



Figure 3.2.6.18: Safety Soap Dispenser

3.2.7 Patient Activity Areas

Patient activity areas consist of living room/dayroom, dining, therapy, group and family meeting room spaces, a quiet room for retreating, and secure outdoor spaces.

The key design priority in these areas is to create an inviting non-institutional environment without features that may facilitate assaults or self-harm. These areas are typically supervised by staff and consequently present less of a safety/security threat than patient bedrooms, bathrooms and other areas where a patient may be left unsupervised for a period of time. Criteria to maintain patient safety in these areas include:

- Lighting and other ceiling mounted items should be recessed or surface mounted to the ceiling with vandal resistant fixtures.
- There should be no sharp wall, furniture or fixture edges that patients could injure themselves on.
- Finishes and furniture should be attractive yet durable, able to resist some abuse and allow for cleaning (see specific guidance from the EOC WG).
- All wall mounted items should be flush mounted and securely fastened with security screws.
- Adequate secure storage rooms should be provided on the unit to prevent carts and other equipment from being stored in the corridor or open alcoves off the corridor.
- Equipment used by patients while supervised, such as computer equipment, and other facility equipment, should be located in rooms that can be locked when not in use.

Corridor Areas:

Handrails/Wall Protection: Corridors in patient areas should have handrails for patient use as required and to protect the wall. Additionally, corner guards and exterior wall corners help protect the wall but also soften a hard edge that a patient could harm themselves on. Handrail and corner guard selections should enhance the aesthetic image of corridors (*Figures 3.2.7.1 & 3.2.7.2*). Use of stained wood incorporated into the handrail system is one example. High impact panels in wood grain patterns or other attractive finish may be used as wainscoting in these corridors to also enhance the wall protection while creating the feeling of wood paneling (*Figure 3.2.7.4*). Along with wood-toned floors, paneling, and accents, this can have a significant positive impact on the aesthetic environment and promote a warm and home-like environment.

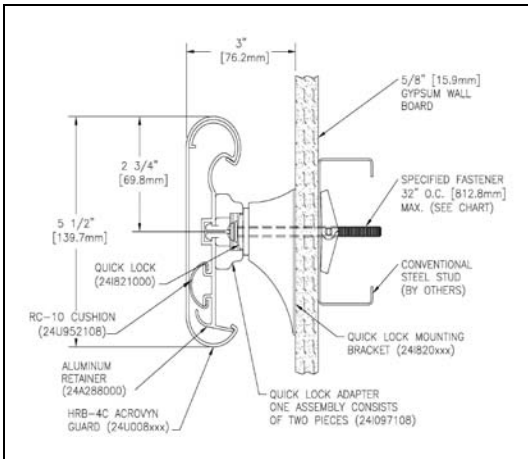


Figure 3.2.7.1 Handrails- Closure Detail

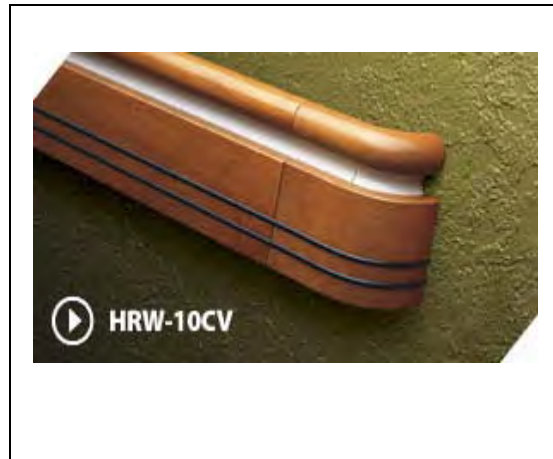


Figure 3.2.7.2: Handrails Example

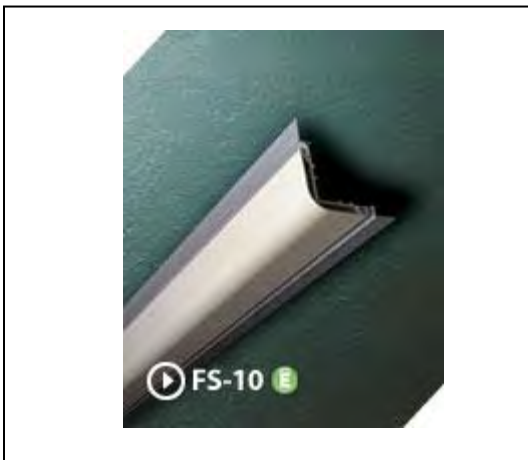


Figure 3.2.7.3: Wall Guard Example



Figure 3.2.7.4: High Impact Panel Wainscot

Inpatient Congregate Areas: (Living Room/Dayroom, Dining Room, Multipurpose):

Living room and dayroom: The aggregate dayroom area programmed for each patient unit should be broken down into a mixture of open and enclosed spaces, including a living room and a dayroom. The unit living room should be open, attractively furnished, and visible from the entry into the unit (see Figure 3.2.7.5). This area may be used for informal socializing, conversing, reading, and relaxing. The dayroom represents an additional small, enclosed area for watching television and engaging in recreational activities of a non quiet type. The separation of the living room and dayroom areas allows for distinct quiet and “loud” spaces.



Figure 3.2.7.5: Inpatient Living Room

Living rooms and dayrooms should be furnished with comfortable chairs and tables that cannot be easily thrown or taken apart and used as a weapon. Lamps, coffee tables and other loose accessories should not be used. To allow defensible personal space, it is recommended that seating consist primarily of single chairs with sofas being long enough to allow space between patients. Furniture edges should be rounded and not easily damaged. Fabrics should be stain resistant, easily cleaned and able to withstand abuse, including punctures. Comfortable, supportive, and residential style furniture (as opposed to plastic or other institutional furniture) should be used to promote a warm and therapeutic environment. Flat-screen televisions should be located within a niche and fastened to the wall with the cord length being less than 12" [304.8 mm] and not accessible to patients. Furniture such as book cases should be built-in with fixed shelves to prevent patients from climbing on, or overturning, this type of furniture.

Dining Room: The dining room may be enclosed or open. Dining tables should be heavy enough not to be thrown and should have pedestal type support to accommodate Veterans with disabilities more easily.



Figure 3.2.7.6: View to Dining Area

Product examples of furniture items are provided below. Additional images and guidance on furniture for inpatient congregate areas is provided in guidance document developed by the VA EOC Design Work Group



Figure 3.2.7.7: Lounge Chair Example



Figure 3.2.7.8: Lounge Chair Example

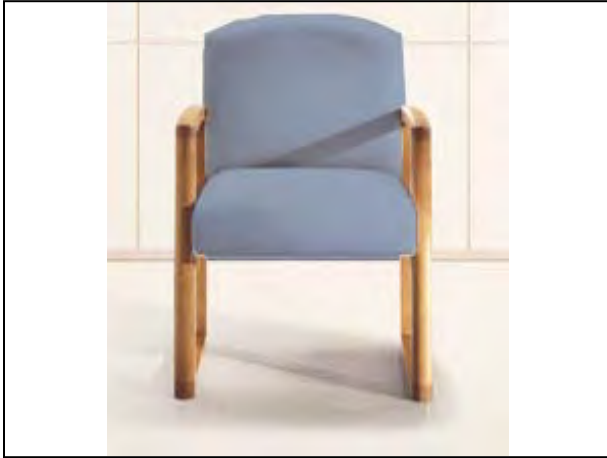


Figure 3.2.7.9: Dining Chair Example



Figure 3.2.7.10: Dining Room Table Example

Group Therapy Rooms: Group therapy rooms are typically only used for scheduled programs with staff present. Furniture and fabrics in these rooms may consist of appropriate heavy-duty commercial furniture that can not be easily thrown or damaged. There are several options for furniture pieces in this space that are durable, aesthetically pleasing, and comfortable. (See also guidance and product examples established by the VA EOC Design Work Group)

In group therapy rooms where video-conferencing is utilized, special provisions for lighting, acoustics, and interior finishing should be provided as summarized below:

Lighting: Auxiliary lighting should be provided to allow soft, diffuse front lighting so a patient's face can be clearly seen on the remote conference screen. In rooms with natural light, window shades with full black out capability should be provided to control glare and shadow in the room during a video-conference.

Acoustics: At least one wall in the room should be covered with a sound absorbing material to minimize reverberation and acoustical tile ceilings may also be used. The room itself should be acoustically isolated from external noise sources such as mechanical noise, street noise or corridor noise.

Interior Finishes: The room should use solid colors preferably in a medium tone color to allow for the best backdrop during video conferences.

3.2.8 Nursing Station Design and Operations

It is essential that the nursing station blend in with the unit in scale and physical appearance. Large nursing stations that overtake the physical space and that are based more on a medical model environment should be avoided. Smaller, more integrated space should be developed for the nursing station on an inpatient mental health unit, to fit with a recovery-oriented model. It is recommended that computer tablets and/or computers-on-wheels (COWs) be incorporated on the unit as supplements to the smaller nursing station and be used for most routine charting purposes.

The nursing station should be open and not enclosed. Enclosed nursing stations were more common in traditional inpatient design approaches. Open nursing stations promote nursing staff engagement with patients and involvement on the unit. Open nursing stations send an important message that staff are accessible and often lead to reduced attention seeking behavior by patients. Nursing staff and patients have been shown to prefer open nursing stations after a change from closed to open nursing stations. If necessary, laminated glass can be installed in the counter top to prevent patients from accessing the nurse work areas (see *Figure 3.2.8.2*). This glass should be as open as much as possible to allow patients to interact with staff – typically 18” laminated glass above the highest counter (frameless to minimize its visual impact) is recommended in such situations.

Bedroom corridors and primary patient activity areas should be directly visible from the nursing station. The primary design focus for the nursing station is to maintain patient confidentiality during significant inputting or reviewing of patient information that requires stationary computer access. The opportunity for equipment within the nursing station to be used as a weapon by the patient should be minimized by integrating computer equipment and storage area into the hardware of the nursing station. Moreover, the nursing station should not serve as a physical barrier that prevents normal interaction between patient and caregiver and sends unintended messages to patients. In addition large spaces behind, or adjacent to, the nursing station should be avoided, as this often serves as a place for staff to congregate rather than to be out on the floor with patients.

Within the nursing station, the task chairs and keyboards should be adjustable to accommodate different staff. The following pages illustrate a circular and linear nurse station approach. These design are included as examples but should not be construed as a prototype. Each example does include key elements such as the provision for a laminated glass counter extension, a workspace alcove directly behind the nursing station and clear visibility to patient activity areas and bedroom wings.



Figure 3.2.8.1: Nursing Station – Typical Option

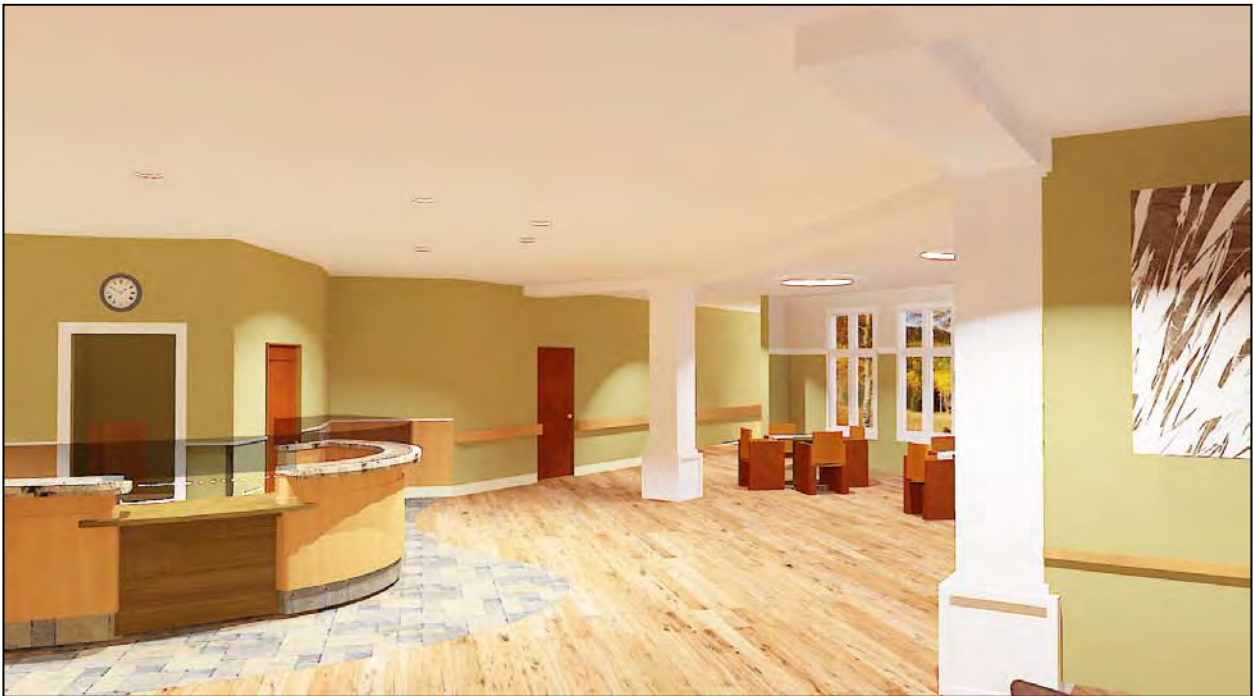


Figure 3.2.8.2: Nursing Station – Optional Glass Partition



Figure 3.2.8.3: Nursing Station – VA Palo Alto
Architect: The Design Partnership LLP

3.2.9 Outdoor Courtyards

An essential component of any inpatient mental health facility should be direct, yet secure access by patients to the outdoors. Outdoor spaces should be designed with three key principles in mind:

1. Located within the unit to be visible by staff from the nursing station.
2. Sufficiently enclosed to discourage the threat of patient elopement.
3. Designed with hard-scape and landscape features that do not support self-harm or assaultive behavior.

In all new construction, and to the greatest extent possible in renovated construction, there should be a secure and safe outdoor space directly accessible from every inpatient unit. It is preferred, when at all possible, that inpatient mental health units be on the ground level to allow for easy access to the outdoors and for incorporation of nature in a village design concept. If it is not at all possible for the inpatient units to be on the ground floor, every effort should be made to establish designated ground floor recreational space to which patients may be escorted. Outdoor courtyard space should be large enough to allow for greater functionality, including walking pathways for patients, and to limit confinement or overcrowding.

Security and safety considerations for outdoor spaces used by inpatients are as follows:

1. Courtyards are preferred over fenced areas for aesthetic, privacy, and security reasons.
2. An enclosure height of 14 feet [4.27 m] is recommended. The design of the enclosure should prevent climbing or use as an anchor point. (EoC 7.2.13.10.1) If a fence is utilized, it should be securely anchored at the bottom to prevent elopement under the fence. Exit/service gates or doors should be strong enough to withstand force and should be locked and alarmed. Any courtyard doors or gates that constitute part of an egress path should have remote unlocking capability and an adjacent intercom to communicate with staff in the event of an emergency.
3. Trees within the area should not facilitate climbing over a wall or fence. Shrubs should be small and low enough that a patient can not hide behind them.
4. Do not use rocks, gravel, dirt and other planting bed or pathway material that could be used as a weapon.

5. Toxic plants and materials should not be used.
6. The outdoor space should be well lit. Light fixtures should be equipped with tamper resistant enclosures and light poles should be avoided particularly near the perimeter of the space.
7. Surveillance cameras should be installed to have a 180 degree view of the outdoor area and should be high enough to prevent patients from tampering with the cameras.
8. Outdoor furniture should either be anchored to concrete pads or too heavy to be moved. Furniture should not be located adjacent to a fence or wall to prevent patient escape. The fixed seating/table shown in Figure 3.2.9.1 may be difficult to use for shorter women, or patients of both genders, with mobility limitations.
9. Elevated outdoor porches must have all openings covered with security screening and/or railings to prevent the potential for jumping. The enclosure must withstand tampering and force.
10. All exposed fasteners in the courtyard area shall receive tamper resistant screws. Devices with exposed fasteners include camera housings, drainage grates, furnishings and light fixtures.



Figure 3.2.9.1: Enclosed Courtyard Example – VA Tuscaloosa, AL



Figure 3.2.9.2: Outdoor Courtyard Example Sheppard-Pratt, Towson, MD

3.2.10 Accommodations for Women Veterans and Other Patient Subgroups

General:

Female patients that are housed in the same unit as other male patients should have separate and secured sleeping accommodations. Female patient rooms, as well as those for geriatric patients, should be in a separate wing or pod, whenever possible, and within close view of the nursing station. A separate small dayroom area should be included to allow for private and safe activity space.

Rooms for geriatric patients should have accessible bathrooms and higher lighting levels.

Locked Entry to Patient Room

All female patient rooms and bathrooms on mixed gender units should have door locks. This requirement is included in VHA Handbook 1160.01, *Uniform Mental Health Services in VA Medical Centers and Clinics*, as follows:

“All inpatient and residential care facilities must provide separate and secured sleeping accommodations for women. Mixed gender units must ensure safe and secure sleeping and bathroom arrangements, including, but not limited to door locks and proximity to staff” (p. 11).

Similar policy is also outlined in VHA Handbook 1330.01, *Healthcare Services for Women Veterans*.

In addition to the requirement for door locks for female patient rooms on mixed gender units, facilities may also consider door locks for rooms for other vulnerable patient populations, including but not limited to geriatric patients. Refer to page 3-17 for patient door locking criteria.

In rare cases, the treatment team may determine that it is contraindicated to place a female patient in a sleeping room that has a corridor door that locks. In such instances, the reasons for not placing the patient in a locking room must be documented in the chart. In addition, when such action is taken, a chart note or e-mail message must be sent to notify the facility Women Veteran Program Manager of the patient and ward location.

Additional information can be found in the Mental Health Environment of Care Checklist for Treating Suicidal Patient dated: 06.04.2010, Item 23.e.

Accommodations in Patient Bathroom:

Nurse Call: Nurse call cords should not be used for inpatient rooms or bathrooms. Nurse call buttons should be provided in patient rooms and bathrooms where nurse call is desired.

Accommodations in Congregate Areas:

Furniture: At least a portion of chairs in all congregate areas should have arms and an appropriate seat height to assist geriatric, and other frail patients, in getting into and out of chairs. Arms in chairs should be solid to prevent them from being used as an anchor point.

Natural Light Control: It is essential that natural light be controlled in the congregate areas for both the comfort of all patients and to ensure visually impaired patients are not adversely impacted by glare.

For additional information on design specifications for older patients, see:

Karlin, B. E., & Zeiss, R. A. (2006) Environmental and therapeutic issues in psychiatric hospital design: Toward best practices. *Psychiatric Services*, 57, 1376-1378.

3.3 Mental Health Residential Rehabilitation Treatment Program (MH R RTP) Facility

3.3.1 Introduction

The Mental Health Residential Rehabilitation Treatment Program (MH R RTP) bed services includes the following models of residential care: Psychosocial Residential Rehabilitation Treatment Programs (PR RTP), Domiciliary Residential Rehabilitation Treatment Programs (DR RTP), Post-Traumatic Stress Disorder R RTP (PTSD-R RTP), Domiciliary Care for Homeless Veterans (DCHV), Substance Abuse R RTP (SAR RTP), and Compensated Work Therapy – Transitional Residence (CWT-TR) Programs. The mission of the MH R RTPS is to provide a 24-hours-per-day, 7 days-per-week, (24/7) structured and supportive residential environment as a part of the rehabilitative treatment regime. Specifically, MH R RTP's provide residential rehabilitative and clinical care to eligible Veterans who have a wide range of problems, illnesses, or rehabilitative care needs which can be mental health, SUD, co-morbid medical, homelessness, vocational, educational, or social. The average length of stay at this facility is approximately 2-3 months. The MH R RTP identifies and addresses goals of rehabilitation, recovery, health maintenance, improved quality of life, and community integration in addition to specific treatment of medical conditions, mental illnesses, addictive disorders, and homelessness (VHA Handbook 1162.02).

The recommended minimum number of accessible resident bedrooms and bathrooms for VA MH R RTP facilities shall be 20 percent. This percentage may be increased if the resident profile necessitates it. ADA guidelines require a minimum of 10 percent for psychiatric residential facilities.

MH R RTPs are required to provide services to women Veterans at a level on par with male Veterans at each facility. Women Veteran capacity in MH R RTPs must be, at a minimum, equivalent to the current proportion of the women Veteran utilization rates or the specific VISN utilization rate for that site, whichever is greater (VHA Handbook 1162.02). As with inpatient facilities, separate and secured sleeping and bathroom arrangements – with provisions for locking – must be provided in these facilities.

Key design concepts for this facility include:

Independent living:

MH R RTP facilities are recommended to have clusters of four residents share a multiple living unit with living/dining and kitchenette facilities. Bedrooms should have no more than two residents per room. Some residents will have jobs outside the facility and may be coming and going at different hours. While the mental health design guide focuses on single bedrooms, VA medical centers

may choose to have two residents per bedroom to foster peer support and a therapeutic community. Residents are encouraged to begin to accumulate personal possessions they can then in turn take with them to furnish a residence outside the MH RRTP; however, the amount and types of items must be reasonable and their presence must have no impact on the cleanliness, safety and security of the living areas.

Institutional occupancy:

While the image of the facility is desired to be residential and non-institutional, the facility should be constructed to institutional building code and life safety standards.

Resident amenities:

Residents will be working at full-time or part time jobs while living here or undergoing intensive therapy or educational programs. Accommodations should be made for constructive use of unscheduled time. This includes indoor and outdoor recreational areas, access to telephone, computers and internet service, television, and reading material.

Facility security/control:

For the safety of all residents and to maintain a successful treatment outcome, access in and out of the facility should be through the main entry, utilizing keyless entry, for all residents and visitors. All other entrance and egress doors must be alarmed (to alert staff to an emergency or unauthorized opening) and monitored by Closed Circuit TV (CCTV). This helps the MH RRTP staff limit the threat of contraband or unauthorized visitors in the facility. CCTV cameras with recording capability are required in MH RRTPs for access points and public areas. Public areas include access points, hallways, and stairwells. They should also be strategically placed to allow staff to monitor portions of the facility they can not directly supervise. CCTV may not be installed in areas where treatment or other clinical activities are conducted or in private spaces, such as bedrooms and bathrooms. Attractive fencing should also be installed to prevent access from the exterior to patient rooms. *NOTE: Specific guidance regarding environment of care requirements for MH RRTPs is outlined in VHA Handbook 1162.02.*

Resident safety/security:

MH RRTPs provide the least intensive level of VA inpatient care and differ from acute inpatient and nursing home beds as Veterans in MH RRTPs do not require bedside nursing care and are generally capable of self-care. While incidences of self-harm or assault should be less than patients in a mental health inpatient unit, provisions should be made to minimize the risk of suicide or injury. Provisions

include shatterproof glazing, no open balconies or stair wells in multi-story buildings and resident room and bathroom doors that can open out in an emergency to prevent resident barricading.

This MH RRTP has recently opened in Pittsburgh, PA. The photo below of the exterior facility conveys the residential feel desired for this type of facility, which is emphasized in the interior as well (*Figure 3.3.1.1*). At this site, the attractive residential character of the exterior also blended in well with the surrounding community. For resident Veterans staying at this facility, as a part of their treatment protocol, the design reinforces the recovery-oriented mission of this facility.



Figure 3.3.1.1
Pittsburgh, PA
VA Domiciliary - Main Entry View
Architect: Astorino
Photographer: Denmarsh Photography



Figure 3.3.1.2
Pittsburgh, PA
VA Domiciliary – Reception Area
Architect: Astorino
Photographer: Denmarsh Photography



Figure 3.3.1.3
Pittsburgh, PA
VA Domiciliary – Detail View of Residential Units
Architect: Astorino
Photographer: Denmarsh Photography

3.3.2 Overall Facility Relationship Diagram

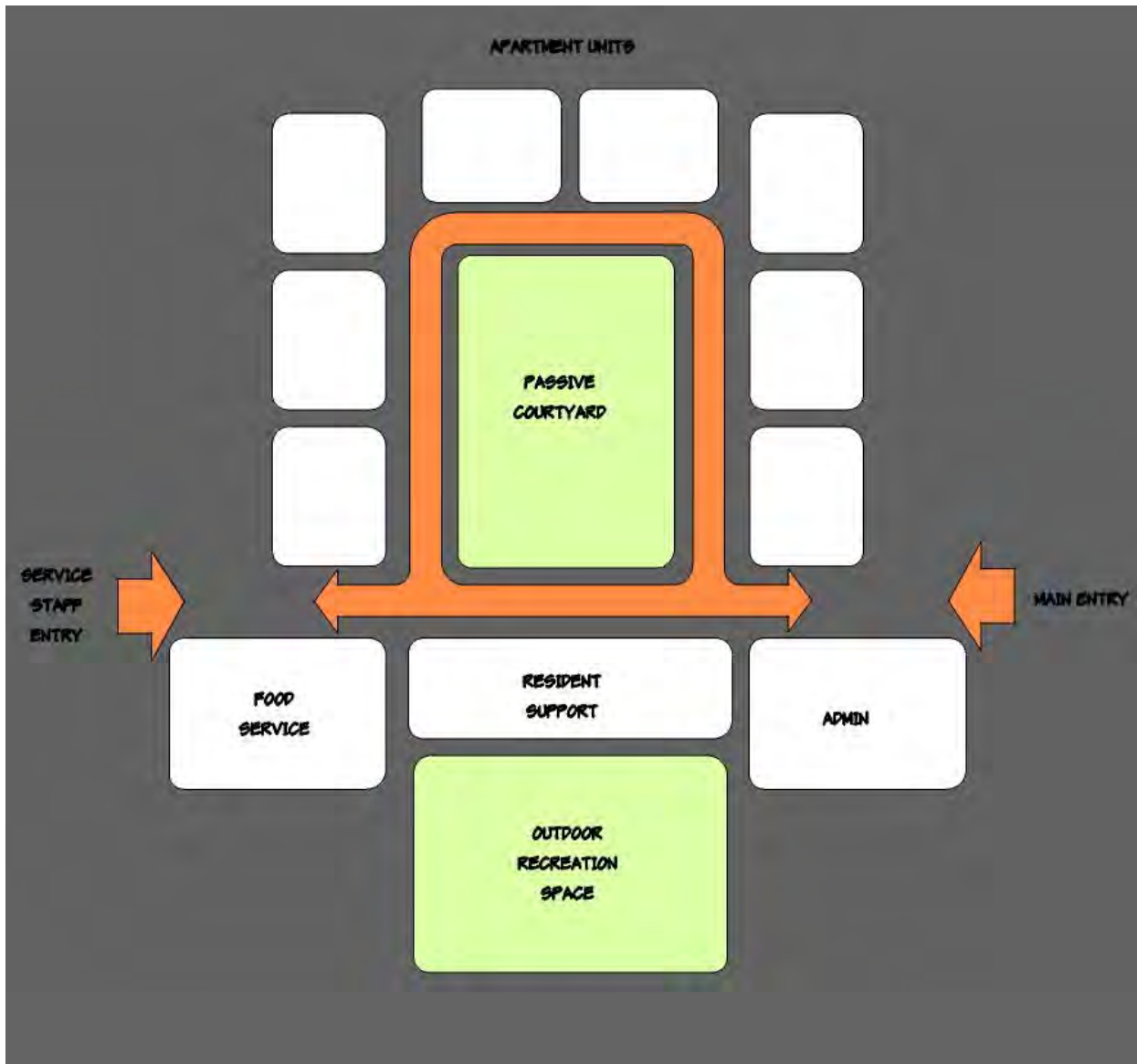


Figure 3.3.2

3.3.3 Resident Room

Resident rooms within a MH RRTP facility should be residential in character. Furnishings and finishes should be selected to withstand high-use. Carpet may be used in resident bedrooms but should be durable and anti-microbial. Windows should be operable but should be limited to an opening of no more than 4” to prevent exiting and entering through this opening.



Figure 3.3.3.1: Patient Room Example
Architect: Astorino
Photographer: Denmarsh Photography



Figure 3.3.3.2: Double Occupancy Room Example
Architect: Astorino
Photographer: Denmarsh Photography

3.3.4 Multiple Occupancy Living Unit

The multiple occupancy living units accommodates living, dining and limited kitchen facilities shared by up to four residents. The goal of this space is to replicate an independent living setting including simple meal preparation. This space should have natural light and views and should be furnished with durable, yet residential style furniture.



Figure 3.3.4: Typical Living Unit Example – VA Pittsburgh

Architect: Astorino

Photographer: Denmarsh Photography

3.3.5 Resident Activity Areas

Resident activity and therapy spaces should be attractive and durable. Natural light should be provided in these spaces wherever possible. Finishes and furnishings should be appropriate to the activity housed in the space. The teaching kitchen shown in Figure 3.3.5.4 illustrates a layout where residents can receive instruction on food preparation and nutrition in a hands-on manner. Residents may also prepare group or individual meals in this space in a supervised setting.



Figure 3.3.5.1: Recreation Therapy Room



Figure 3.3.5.2: Teaching Kitchen, Bedford VA

3.3.6 Outdoor Activity Spaces

Outdoor activity spaces for residents should consist of both passive and active spaces. Passive outdoor areas ideally would be in a courtyard and allow residents a quiet setting to visit with family, visitors, staff, or other residents. Active outdoor spaces should provide space for appropriate recreational activities such as basketball.



**Figure 3.3.6
Outdoor Activity Spaces**

3.4 Outpatient Services

3.4.1 Introduction

Four primary mental health outpatient components in the VA mental health care system include:

- Mental Health Clinic
- Substance Abuse Clinic
- Psychosocial Rehabilitation Recovery Center (PRRC)
- Psychological Services

Additionally, outpatient mental health services may be provided as a functional area of a Primary Care Clinic. Psychological Services, Mental Health Clinic and Substance Abuse Clinic may be located as part of a Mental Health Center with inpatient services, or as part of a VA Medical Center. The PRRC may also be located within these Centers but ideally would be located independent of other mental health services.

A brief narrative of each of these outpatient components, along with a component space relationship diagram and other pertinent illustrations, are provided in this section. Additional information pertaining to patient services provided and operational intent can be found in VHA Handbook 1160.01, http://www1.va.gov/vhapublications/ViewPublication.asp?pub_ID=1762

3.4.2 Mental Health Clinic

Mental Health Clinics provide general and specialty mental health services for Veterans being evaluated, diagnosed, and treated on an outpatient basis. Services include:

- Diagnostic and treatment planning evaluations for the full range of mental health problems
- Treatment services, including individual, group, and family psychotherapy, pharmacotherapy, and sometimes other somatic treatments
- Cognitive and psychological assessment services
- Patient education
- Consultation services

Key design concepts for this clinic include:

1. Patient spaces should have an attractive, therapeutic environment. Incorporate wall color, trim, accent colors, and securely-anchored artwork in common areas and patient therapy rooms to enhance the environment.

2. The clinic planning and design should maintain patient privacy and dignity for a diverse Veteran population with different treatment protocols.
3. The circulation (corridors) in this clinic should be open, easily observed from the reception desk.
4. There should be ample signage that is clear and has large letters that can be read from a distance by patients, some of whom have imperfect vision.
5. Therapy room areas should have appropriate acoustic control.
6. Include an identifiable reception area, for greeting patients, family members, and other visitors that is adjacent to a comfortable waiting area. The waiting area should provide some privacy.
7. Separate sub-waiting areas should be provided for women patients and their families.
8. All areas must be wheelchair-accessible. Corridors should be a minimum of 6 [1.83 m] feet clear to allow passage of two wheelchairs.
9. Ample light should be provided in common hallways.
10. Provide outdoor space to allow patients to sit or talk with others outside, when possible.
11. The overall reception/waiting area should be subdivided into smaller waiting areas easily observed from a central reception point.
12. Exposed devices should be fastened with tamper resistant fasteners. Laminated glass should be used in areas readily accessed by Veterans.
13. Therapy rooms and space for tele-mental health technology should have appropriate acoustic and light control.

Mental Health Clinic Relationship Diagram

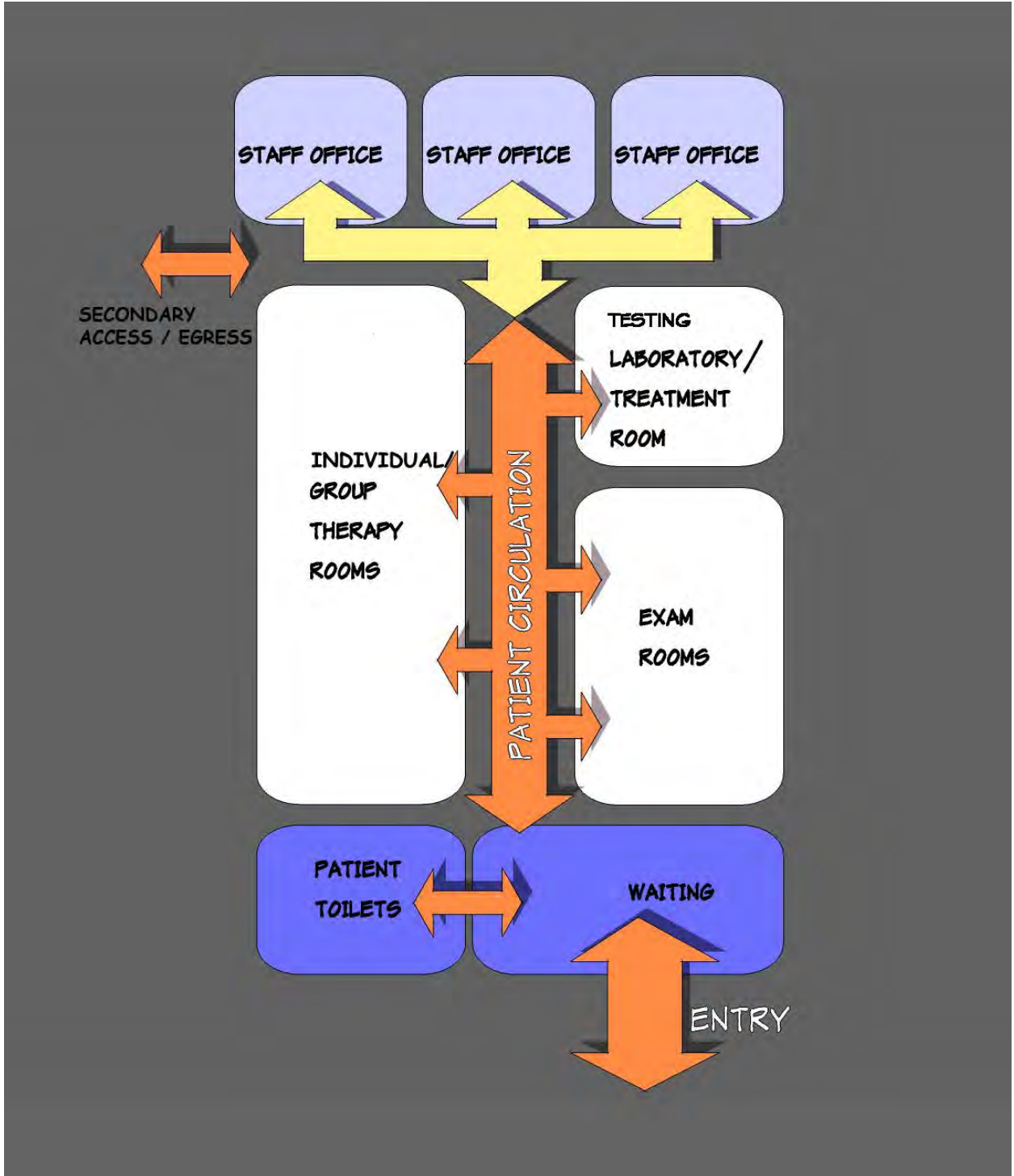


Figure 3.4.2

3.4.3 Substance Abuse Clinic

The Substance Abuse Clinic serves patients, provides outpatient screening, diagnostic assessment, and treatment for various substance use disorders (SUD). Serving a range of special Veteran populations, patients receiving care in this clinic may include homeless, ethnic minorities, women, geriatric patients, and patients with PTSD and other psychiatric conditions, as well as infectious diseases (e.g., HIV, AIDS, hepatitis C), traumatic brain injury (TBI) and spinal cord injury (SCI).

Because most SUD's are chronic or episodic recurring conditions that require ongoing care, Veterans receiving treatment at this facility, along with their families, will often access the clinic frequently. Intensive outpatient services typically last 3 hours per day, 3 days per week. Medically supervised withdrawal management may also be provided at this clinic. Consequently, the waiting area in this clinic should be comfortable for family members waiting for a patient receiving treatment or therapy. Direct access, where possible, to an attractive outdoor space is also recommended as an area for patients and families to decompress.

To accommodate the full range of Veterans using this clinic, the layout should be fully accessible and rooms used by patients for examinations, counseling and other treatment should have appropriate visual and acoustic privacy.

Key design concepts for this clinic include:

1. Patient spaces should have an attractive, therapeutic environment without compromising patient and staff safety. Incorporate wall color, trim, accent colors, and securely-anchored artwork in common areas and patient therapy rooms to enhance the environment.
2. The clinic planning and design should maintain patient privacy and dignity for a diverse Veteran population with different treatment protocols.
3. The circulation (corridors) in this clinic should be open, easily observed from reception and nursing stations, and should be free of blind corners.
4. Provide outdoor space to allow patients to sit or talk with others outside, when possible.
5. There should be ample signage that is clear and has large letters that can be read from a distance by patients, some of whom have imperfect vision.
6. Therapy room areas should have appropriate acoustic control.

7. Include an identifiable reception area, for greeting patients, family members, and other visitors that is adjacent to a comfortable waiting area. The waiting area should provide some privacy from common traffic.
8. The overall reception/waiting area should be subdivided into smaller waiting areas easily observed from a central reception point. There should be at least two distinct waiting areas to separate patients undergoing medically supervised withdrawal management from patients being treated at the facility through intensive counseling.
9. All areas must be wheelchair-accessible. Corridors should be a minimum of 6' [1.83 m] clear to allow passage of two wheelchairs.
10. Ample light should be provided in common hallways.
11. Areas where patients are minimally supervised such as patient toilet rooms should be outfitted to minimize the potential for fixtures, and accessories within the room to be used as a weapon or anchor point for hanging. Grab bars should have a solid plate behind the bar. All plumbing fixture piping should be concealed and motion sensors should be used for toilet and lavatory operation.
12. Exposed devices should be fastened with tamper resistant fasteners in any area where a patient is left unattended. Laminated glass should be used in areas readily accessed by Veterans.

Refer to previous inpatient and outpatient sections for illustrations of appropriate design criteria for these clinics.

Substance Abuse Clinic Relationship Diagram

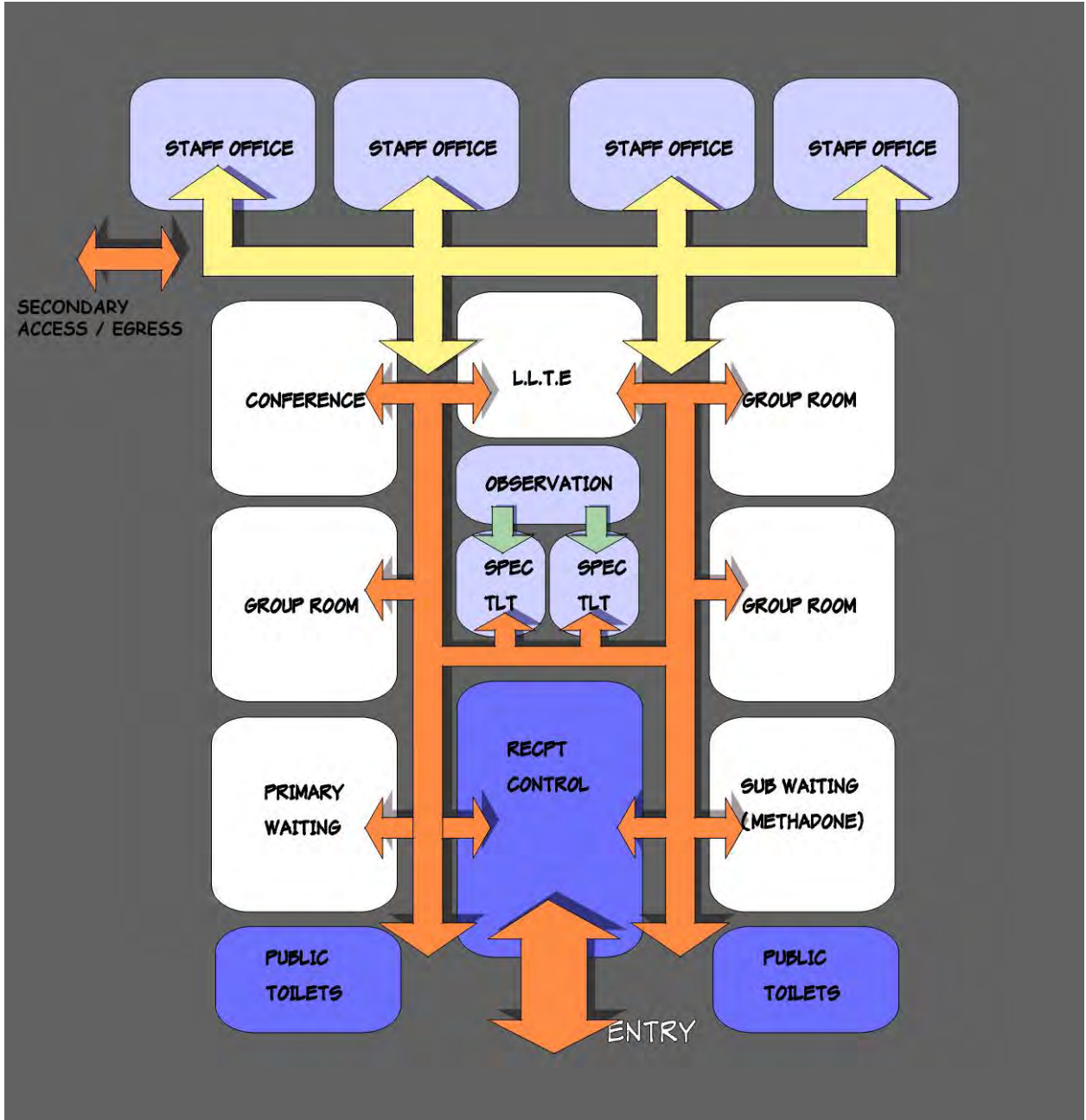


Figure 3.4.3

3.4.4 Psychosocial Rehabilitation Recovery Center (PRRC)

The President's New Freedom Commission report on mental health, the VA Mental Health Strategic Plan (MHSP), and the Uniform Mental Health Services in VA Medical Centers and Clinics (VHA Handbook 1160.01) calls for a transformation of VA mental health care to a recovery oriented model. A key component of this transformation detailed in VHA Handbook 11601.01 involves transforming all existing Day Treatment Centers (DTCs), day hospitals, partial hospitals, or analogous programs to Psychosocial Rehabilitation Recovery Centers (PRRCs) and establishing new PRRCs where they are needed. These older programs are outpatient stabilization programs for Veterans challenged with serious mental illness and significant functional impairment. The primary aim of these programs has been to manage chronic symptoms and to assist Veterans with avoiding re-hospitalization. These older programs have limited expectations for those in the program to recover or to be fully integrated into the community.

PRRCs are replacing these older programs and are designed to help Veterans, challenged with serious mental illness and significant functional impairment, integrate into meaningful self-determined community roles. In contrast to valuing stabilization, PRRCs are designed to assist with the transformation from "illness" to "person." Specifically, PRRCs have the expectation that all people, including those with serious mental illness and significant functional impairment, have the capacity to learn and are capable of developing meaningful self-determined roles and goals in the community. PRRC programming curricula is geared to empowering Veteran's to work toward achieving their hopes and dreams (i.e., defining roles and goals for a better future).

Design Criteria:

1. Location: Whenever possible Psychosocial Rehabilitation Recovery Centers should be located in the community and away from a VA Medical Center. When a distinct location is not possible, every effort should be made not to locate the PRRC adjacent to a mental health treatment center.
2. Patient spaces should have an attractive, open, therapeutic feel without compromising patient and staff safety. Incorporate wall color, trim, accent colors, and artwork in common areas and rooms to enhance the aesthetic environment.
3. The clinic planning and design should maintain patient privacy and dignity for a diverse Veteran population with different treatment protocols.
4. There should be ample signage that is clear and has large letters that can be read from a distance by patients, some of whom have imperfect vision.

5. Therapy room areas should have appropriate acoustic control.
6. The overall reception/waiting area should be subdivided into smaller waiting areas easily observed from a central reception point. There should be at least two distinct waiting areas to separate patients undergoing medically supervised withdrawal management from patients being treated at the facility through intensive counseling.
7. Communication Center: Area adjacent to waiting room includes space for secretary/receptionist, office supplies, copy machine/fax, file room storage.
8. Ample light should be provided in common hallways.
9. Lighting: Natural lighting should be provided wherever possible, while still providing for appropriate privacy. Supplemental lighting should be provided as required and to supplement natural lighting. In addition, special lighting fixtures designed to address seasonal affective disorder should be included in areas designated by the program manager.
10. All areas must wheelchair accessible. Corridors should be a minimum of 6' [1.83 m] feet clear to allow passage of two wheelchairs.
11. Outdoor Space: All PRRC's should include an enclosed attractive outdoor space for PRRC program participants to enjoy as a part of their daily routine at the PRRC. This outdoor space should be landscaped, furnished and shaded to allow program participants to utilize this space for activities such as dining and conversing with other program participants.
12. A minimum of three (3) classrooms/group rooms to support programming simultaneously occurring on different topics. The size of each classroom/group room should be sufficient to comfortably seat 30 Veterans. Should census/population differentials require it at larger facilities, additional classrooms may be added.
13. Space for a recovery resource area (i.e., private area where Veterans enrolled in PRRC programming can peruse books, pamphlets, workbooks, DVDs, video cassette tapes, etc related to recovery topics). Space should be constructed in such a way as to permit Veterans to watch audiovisual materials (e.g., DVDs, CDs, videocassette tapes) without interfering with other Veterans that are reading/perusing other recovery-oriented printed materials.

14. A full kitchen with major appliances and the usual amenities (stove, microwave, dishwasher, double sink, refrigerator, cabinets) is part of a PRRC. It will be used to teach skills necessary to become independent in food preparation and meal planning. Many of the Veterans seen in PRRCs are in need of learning these basic life skills necessary for independent living in the community.
15. All programs, even those located at hospitals, should have access to some outdoor space. This is necessary for PRRC program participants to renew themselves during their extended participation in the program.
16. Large multi-purpose room for multi-family therapy sessions.
17. Exam/treatment room for health screenings.
18. Multi-purpose room for occupational therapy, art, and computer with internet access.
19. Quiet room or sensory modulation room.
20. Storage room for art supplies and Occupational Therapy supplies.
21. Control room equipped with one-way viewing capability and used as part of teaching.
22. Adequate access to restrooms adjacent to the PRRC. Only one set of restrooms within or adjacent to the PRRC is necessary. PSR principles do not support separate facilities for staff and patients. Number of commodes and other fixtures should be dependent upon number of staff and patient census.
23. Office, PRRC Program Coordinator/Director: Provide one per PRRC.
24. Office, Counselor: Provide one per FTE psychiatrist, psychologist, advanced practice psychiatric nurse, peer support technician, occupational therapist, peer support specialist, social worker, vocational rehabilitation specialist, rehabilitation technician positions or other FTE direct service positions authorized. Offices should allow for the placement of white noise machines to help ensure audio privacy in the event soundproofing materials used in the construction prove inadequate.
25. Cubicle, Clerk: Provide one for each FTE position requiring a cubicle.
26. Staff lounges.
27. Staff lockers.

Psychosocial Rehabilitation and Recovery Center

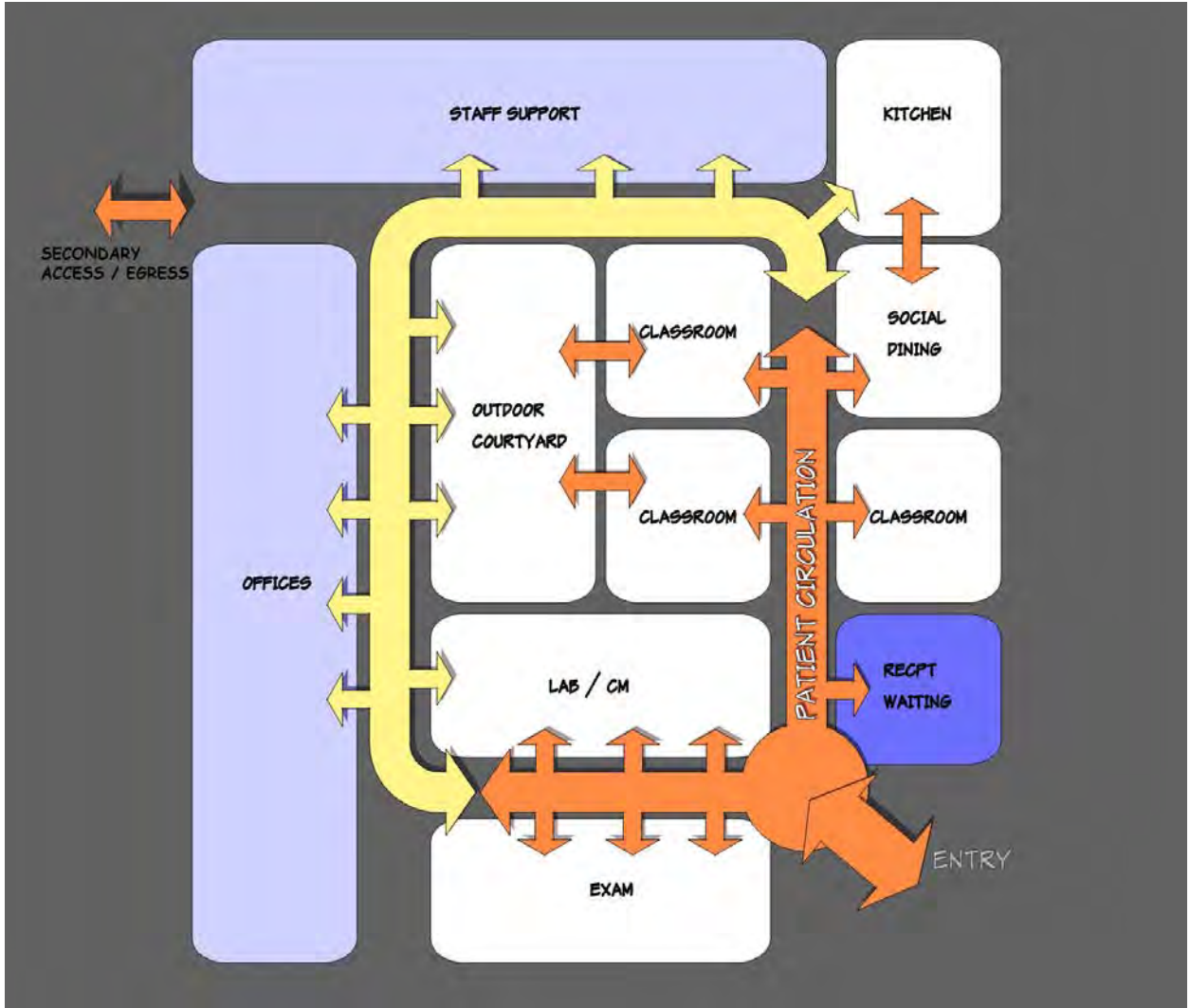


Figure 3.4.4

3.4.5 Psychology Services

Psychology Services are sometimes a distinct component in a medical center and consist primarily of offices and related space used by psychologists, mental health professionals, psychology trainees, and administrative and clerical staff. Patients are seen in this component if a Mental Health clinic is not nearby. Accommodations for biofeedback are listed in the Space Criteria for this section, but are not always used. Other computer-related testing is more frequently used as part of psychological and neuropsychological assessments. This space should include staff offices, trainee offices, administrative offices, clerical staff space, therapy rooms, one or more conference rooms, a patient waiting room, a library or similar area for storing clinical, educational, and bibliotherapy materials. Audio-video equipment is often used by trainees for recording discussions during clinical supervised sessions.

Key design concepts for this component include:

1. Create an attractive, non-institutional environment through careful attention to architectural features and interior design elements.
2. Corridors within this area should be open, easily observed from the reception area, and free of blind corners.
3. Therapy rooms should have appropriate acoustic control.
4. Incorporate wall color, trim, accent colors, and securely-anchored artwork in common areas.
5. Ample light should be provided in common hallways.
6. Include a waiting area for patients, families, and other visitors. The waiting area should provide some privacy from common traffic.
7. Include an identifiable reception area in or adjacent to the waiting area where patients can check-in.
8. Provide ample signage that is clear and has large letters that can be read from a distance by patients, some of whom have imperfect vision.
9. All areas must be accessible. Corridors should be a minimum of 6 feet clear to allow passage of two wheelchairs.

Psychology Services Relationship Diagram

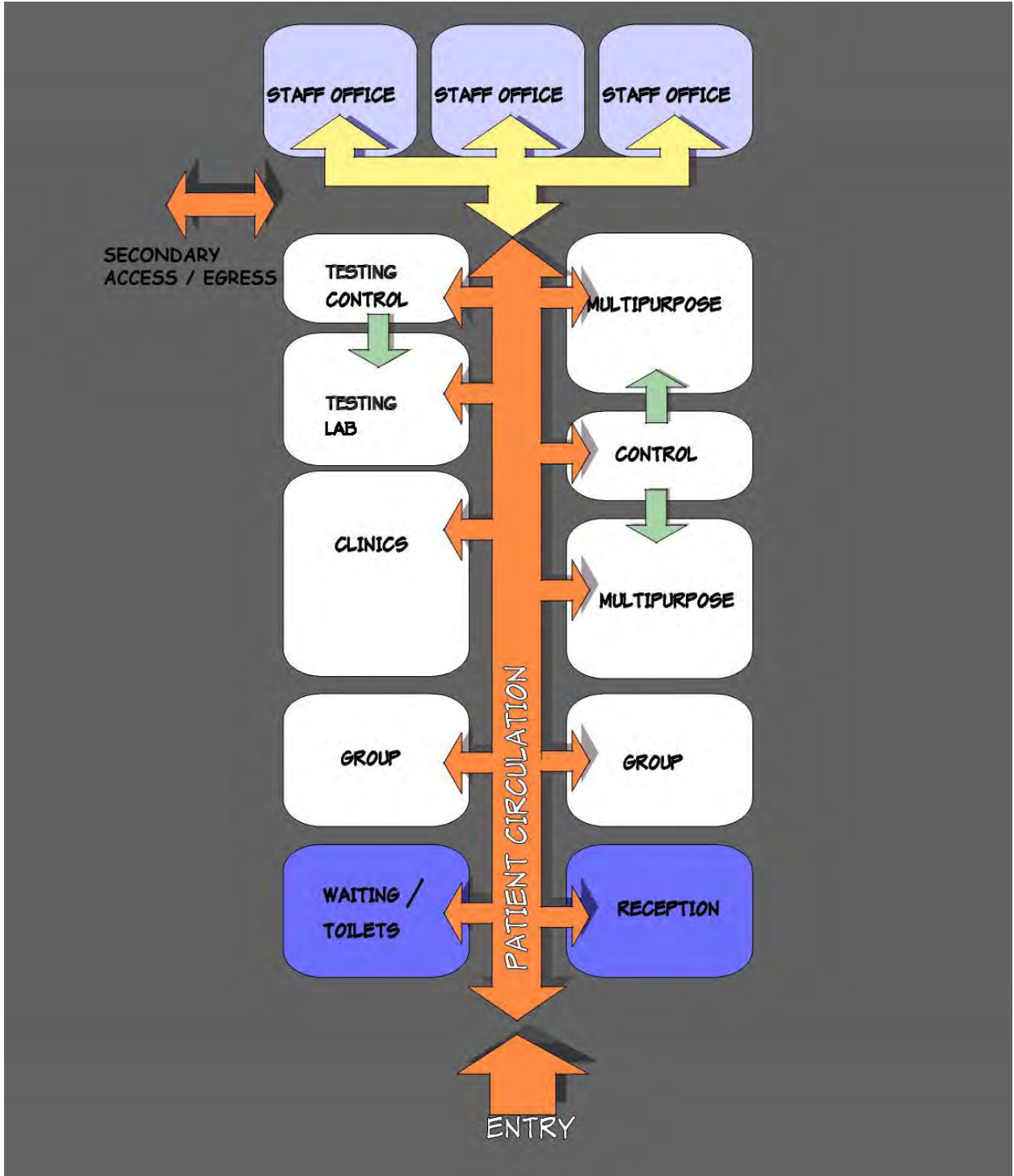


Figure 3.4.5

3.4.6 Primary Care-Mental Health Integration Services

Integration of staff providing collaborative mental health services within primary care clinics is a major focus of transformational efforts in VA. This effort is supported by extensive scientific literature which demonstrates many primary care patients with prevalent mental health disorders (depression, anxiety, and alcohol misuse) do not obtain high –quality treatment for these conditions. In particular, many referrals to specialty care either are not accomplished or do not lead to realized access of effective treatments. In response, VA is supporting implementation of evidence-based components that integrate high-quality, recovery-oriented treatments within the primary care setting itself. Components of integrated care include: a) co-located collaborative care, typified by mental health staff providing in-person direct patient services and/or inter-professional consultation in concert with primary care providers; and b) care management, typified by nurses providing telephonic (and sometimes in-person) assessment, education, and follow-up.

In addition to important design features of primary care clinics in general, key design concepts for space dedicated to primary care-mental health integration include:

1. Create an attractive, non-institutional environment through careful attention to architectural features and interior design elements.
2. Examination rooms for co-located collaborative mental health staff should be within the primary care clinic itself ('en suite') to maximize availability to both patients and primary care providers. Ideally, these rooms and thus the location of the co-located staff will be fixed rather than assigned based on daily clinic schedules. The effect of barriers such as intervening hallways and rotating locations of co-located mental health staff should not be underestimated in planning the layout and flow of the clinic.
3. Ideally, care managers would also be located en suite in the primary care clinic, to facilitate in-person interaction with both patients and primary care providers. At a minimum, availability of examination room space for intermittent use by care managers seeing patient's in-person should be incorporated into clinic design.
4. The clinic planning and design should maintain patient privacy and dignity for a diverse Veteran population with different treatment protocols. Privacy is a principal concern in all health care interactions but is particularly important when involving sensitive matters such as mental health. Thus, due discretion is indicated in assigning examination rooms for staff often involved in mental health or substance use treatment. Furthermore, locations used as therapy rooms by co-located mental health staff will ideally have appropriate acoustic control, and achieving this goal

- should be incorporated into any new renovation projects of existing primary care clinic space.
5. There should be ample signage that is clear and has large letters that can be read from a distance by patients, some of whom have imperfect vision. Furthermore, signage that clearly identifies the location of mental health staff can facilitate the ease and extent of collaboration between mental health staff and primary care providers.
 6. Include a waiting area for patients, families, and other visitors. The waiting area should provide some privacy from common traffic.
 7. Ample light should be provided in common hallways.
 8. All areas must be wheelchair-accessible. Corridors should be a minimum of 6 feet [1.83 m] clear to allow passage of two wheelchairs.

(This page intentionally left blank)



Department of
Veterans Affairs

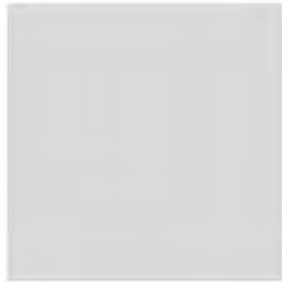
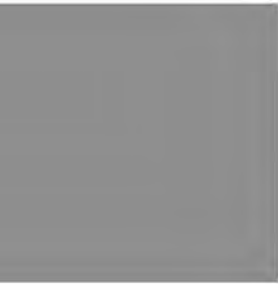
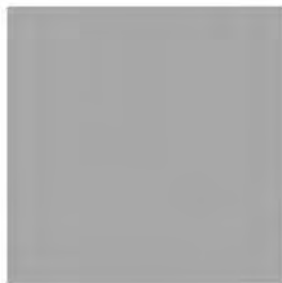
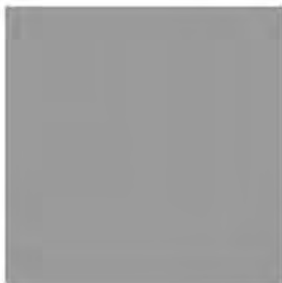


Office of Construction &
Facilities Management

Section 4

GENERAL TECHNICAL NARRATIVE

MENTAL HEALTH FACILITIES DESIGN GUIDE



4.0. TECHNICAL NARRATIVE

4.1. Codes and Standards

4.1.1. National Codes and References

Purpose: The Public Buildings Amendment Act of 1988, Public Law (Pub.L.) 100-678 requires Federal Agencies to follow national recognized “model” building codes. The Federal Participation in the Development and Use of Voluntary Standards, Office of Management and Budget (OMB) Circular A-119, requires all executive agencies to rely on voluntary standards, both domestic and international, whenever feasible, and to participate in voluntary standard bodies.

General: The VA has adopted the latest edition of the following codes and standards as a minimum for all projects performed in the modernization, alteration, addition, or improvement of its real property and the construction of new structures. VA Design Manuals and Master Specifications specify other codes and standards the VA follows on its projects:

1. VA Directives, Design Manuals, Master Specifications, VA National CAD Standard Application Guide and other Guidance in the Technical Information Library (TIL) <http://www.cfm.va.gov/til/> .
2. International Building Code (IBC) including International Mechanical and Plumbing Codes
3. National Fire Protection Association (NFPA) 101 Life Safety Code (see notes below)
4. NFPA National Fire Codes with the exception of NFPA 5000 and NFPA 900
5. Occupational, Safety and Health Administration (OSHA) standards.
6. VA Seismic Design Requirements, H-18-8
7. National Standard Plumbing Code (NSPC).
8. Safety Code for Elevators and Escalators A 17.1, published by American Society of Mechanical Engineers (ASME)
9. ASME Boiler and Pressure Vessel Code
10. ASME Code for Pressure Piping

11. Uniform Federal Accessibility Standards (UFAS), including VA Supplement Barrier Free Design Guide
12. Building Code Requirements for Reinforced Concrete (ACI 318), published by the American Concrete Institute.
13. Manual of Steel Construction, Load and Resistance Factor Design Specifications for Structural Steel Buildings, published by the American Institute of Steel Construction (AISC).
14. Energy Policy Act of 2005 (EPAAct).
15. DOE Interim Final Rule: Energy Conservation Standards for New Federal, Commercial and Multi-Family High-Rise Residential Buildings and New Low-Rise Residential Buildings, 10 CFR Parts 433, 434 and 435.
16. Federal Leadership in High Performance and Sustainable Buildings: Memorandum of Understanding (MOU)
17. Executive Order 13423: Strengthening Federal Environmental, Energy, Transportation Management.
18. The Provisions for Construction and Safety Signs, stated in General Requirements Section 01010 of the VA Master Construction Specification.
19. Ventilation for Acceptable Indoor Air Quality – ASHRAE Standard 62.1-2007, published by the American Society of Heating, Refrigerating and Air-Conditioning Engineers, Inc.
20. Safety Standard for Refrigeration Systems – ASHRAE Standard 15-2007, published by the American Society of Heating, Refrigerating and Air-Conditioning Engineers, Inc.
21. Greening the Government through Leadership in Environmental Management – Executive Order 13148.
22. Design Guide for Humidity Control in Commercial and Institutional Buildings; 2001, published by the American Society of Heating, Refrigerating and Air-Conditioning Engineers, Inc.
23. The Joint Commission (TJC) Environment of Care Emergency Management and Life Safety Standards

24. *Mental Health Environment of Care Checklist* - VHA National Center for Patient Safety, Department of Veterans Affairs (most current ed.).
<http://www.patientsafety.gov/SafetyTopics.html#mheocc>

Notes:

1. NFPA 101 primarily addresses life safety and fire protection features while the IBC addresses a wide range of considerations, including, but not limited to, structural strength, stability, sanitation, adequate light and ventilation, and energy conservation. VA buildings must meet the requirements of NFPA 101 and documents referenced by NFPA 101 in order to comply with the accreditation requirements of The Joint Commission. Therefore, designs shall comply with the requirements of the latest edition of NFPA 101 and documents referenced therein. Design features not addressed by NFPA 101 or documents referenced therein shall comply with the requirements of the latest edition of the IBC or as otherwise addressed above in this Program Guide. For design features that are addressed by both the IBC as well as NFPA 101 or a document referenced by NFPA 101, the requirements of NFPA 101 or the document referenced by NFPA 101 shall be used exclusively (this applies even if the IBC requirements are different).
2. Conflicts between Nationally Recognized Codes and Standards and VA Requirements - Should a conflict exist between VA requirements and VA adopted nationally recognized codes and standards, the conflict shall be brought to the attention of the VA. The resolution of conflict shall be made by the authority having jurisdiction for VA to ensure a consistency system wide.

4.1.2. Other Recommended References and Standards

There are increasing research efforts underway in the field of health care design to further identify environmental and design features that can enhance patient well-being, recovery, and safety. Research, particularly well controlled empirical research, on mental health facilities is more limited, though there are some consistent findings and themes reported in the literature (see Karlin & Zeiss, 2006, for a review); moreover, some evidence-based findings from research on general health care facilities are directly applicable to the design of mental health facilities. The following are some key references for evidence-based approaches and best practices in mental health and health care facility design:

1. *Guidelines for Design and Construction of Hospital and Health Care Facilities, 2006 Edition (Guidelines 2006)*, published by the American Institute of Architects Academy of Architecture for Health and the Facilities

- Guidelines Institute, with assistance from the U.S. Department of Health and Human Services.
2. Karlin, B. E., & Zeiss, R. A. (2006). Environmental and therapeutic issues in psychiatric hospital design: Toward best practices. *Psychiatric Services*, 57, 1376-1378. This article identifies key principles and design recommendations for creating therapeutic environments in inpatient psychiatric facilities, based on a review of the literature. It provides specific recommendations and approaches that now form the basis of the VA's new model for designing recovery-oriented inpatient mental health facilities.
<http://psychservices.psychiatryonline.org/cgi/content/full/57/10/1376>
 3. United States Green Building Council (USGBC) Leadership in Energy and Environmental Design (LEED) Project Certification – current version.
 4. *Design Guide for the Built Environment of Behavioral Health Facilities: Second Edition* by David Sine, ARM, CSP, CPHRM and James M. Hunt, AIA. Available on the web site of the National Association of Psychiatric Health Systems (NAPHS).
 5. *Bariatric Room Design Advisory Board (BRDAB)* formed by The Hill-Rom Company. There are currently no standards or guidelines specifically related to bariatric patient room design. This group has established some recommendations that will be referenced in the Bariatric Design Guide Plates.
 6. *Telehealth Resource Guide Section 3: Telehealth Planning Essentials/Planning the Telehealth Environment*.
 7. *Center for Medicare & Medicaid Services (CMS) – Memo & Worksheets*.
 8. *United States Gypsum Board- Abuse Resistant Systems - SA929 09250*
 9. *Center for Health Design - www.healthdesign.org* - The Center for Health Design has been a leader in providing findings of on-going research related to evidence-based Healthcare Design. The intent of this program is to establish and document evidence that indicates a particular design intervention has a direct correlation in improving a health care outcome.
 10. *Putting Patients First- Best Practices in Patient Centered Care, 2nd edition*. Planetree - www.planetree.org - As stated on their website, Planetree “is a non-profit organization that provides education and information in a collaborative community of healthcare organizations, facilitating efforts to create patient centered care in healing environments.”

11. *Common Mistakes in Designing Psychiatric Facilities (September 2009)*
by David Sine, ARM, CSP, CPHRM and James M. Hunt, AIA. American
Institute of Architects Health Online Journal.

4.1.3. Local Codes and References

As an agency of the federal government, VA is not subject to local imposition of code enforcement procedures (drawing reviews, building permits, inspections, fees, etc.). VA must function as the Authority Having Jurisdiction (AHJ) and thus has the responsibility to guard public health and safety through enforcing its adopted codes. However, local authorities should be notified about planned projects and given the opportunity to review drawings provided that VA does not pay for review or inspection fees.

4.1.4. HIPAA

The Healthcare Insurance Portability and Accountability Act of 1996 (HIPAA) protects individuals rights to audible as well as visual privacy. This is especially the case with respect to protection of each individual's medical records, private information, and communications. The law protects all conversations between patients and admission interviewers, caregivers, nurses, psychiatrists, psychologists, physicians, and families. Serious breaches of those rights to privacy are subject to Federal litigation.

Both inpatient and outpatient facilities must now consider the design of rooms and spaces, seeking to keep private conversations from being overheard and prevent private records from being seen on computer screens. Planning of staff stations, reception desks, conference rooms, offices, treatment rooms, and therapy rooms, where exposed private records may be seen and conversations overheard by unauthorized persons, should be addressed as a part of the design process.

4.1.5. Emergency Provisions

Life Safety Systems:

All units or facilities referenced in this Design Guide should be fully sprinklered. In areas where patients are left unattended for periods of time, sprinkler heads that are tamper resistant and cannot be used as an anchor point should be installed. Other life safety items such as smoke detectors, visual and audible fire alarms, and fire extinguisher cabinets should also be specified as vandal resistant and located to prevent abuse.

Emergency Egress:

All mental health inpatient units should be designed as locked units. All egress doors in the unit shall have the capability for remote door release when the occupants need to be evacuated in an emergency.

Residential facilities such as MH RRTP facilities should be designed with remote emergency exits being alarmed with a delayed egress function. If the panic bar on a remote emergency exit door is engaged, the security camera monitoring that door should automatically be called up on the main reception desk monitor. This function prevents visitors and residents from either entering or leaving the facility without passing by the main reception desk.

Outpatient facilities should have unrestricted emergency egress. Secondary exits may be alarmed and monitored by security cameras if necessary.

Delayed or remote release doors in the path of egress require review with the VA and other applicable authorities having jurisdiction.

Evacuation:

Planning an inpatient mental health unit or facility to allow for horizontal evacuation to a safe area of refuge is strongly recommended. Horizontal evacuation, even on the ground floor, allows patients and staff to evacuate to a place of safety without the risk of elopement involved in evacuating patients directly outside.

Disaster Planning:

Mental Health in-patient and out-patient facilities that are part of a VA Medical Center will most likely be classified as a Mission Critical facility. Designers should coordinate with each Medical Center to establish specific disaster planning requirements such as emergency power, alternate utility sources and building hardening. To the greatest extent feasible, a mental health inpatient or residential facility should have necessary emergency provisions to mitigate the need to evacuate patients & residents to a remote location without compromising patient comfort and safety. This Design Guide recommends establishing a disaster contingency plan as a part of the facility design process. This is especially important when the facility is located in an area where a high probability of threat exists from natural disasters such as hurricanes and earthquakes.

Emergency Response:

All inpatient and outpatient units should have a secondary access to the unit or clinic that allows an emergency response team an alternate access to a unit or clinic without having to go through the main entrance to patient-specific emergencies.

4.2. Site Design Guidelines

4.2.1. Introduction

Site analysis and planning are influential to the success of a project. At the beginning of the design process, the design team should perform several preliminary analyses that will affect the final design of the facility. Several of the site related factors required for a mental health facility are identified in this section and are to be considered as essential tools for planning. Each project designer should consider the project specifics that include, but are not limited to:

- Site Area
- Site Geometry
- Local Zoning
- Topography
- Regional and Climatic Factors
- Utilities
- Other Site Characteristics

4.2.2. Planning

When planning a new mental health facility on a new site, particularly an inpatient facility, consider first the feasibility of accommodating the facility space program in a single story. A single story inpatient facility, organized in a village-like design concept, allows abundant natural light into patient areas and, for inpatient units, allows direct access to exterior courtyard spaces. These features dictate a large footprint that the site's size, geometry and topography may not support. Additionally, when a facility goes beyond 120 beds or so, the travel distances within a single story facility become excessive. However, a single story inpatient facility is recommended when at all possible to provide patients with serious mental health needs with a functional and aesthetic environment that provides them with the greatest chance of achieving recovery.

The activities of maintenance personnel, support service providers, emergency crews, and utility workers should be accommodated on site in such a manner that they are as unobtrusive as possible for the patients, visitors, and clinical staff using the facility.

The completed site should include:

- Landscaped Features
- Setbacks and Buffers
- Adequate Parking for Staff and Visitors
- Safe, attractive circulation for pedestrians from the parking areas and public transportation stops

- Access for Emergency Vehicles
- Utility and Service Access
- Covered Entry
- Signage – Wayfinding

Requirements for parking are generated by staff, visitors, service technicians, and deliveries.

The AIA Guidelines for Design and Construction of Health Care Facilities suggest on-site parking count be based on the number of staff likely on site during the day shift with an additional 1.5 parking space per patient bed. The number may be reduced if public transportation is readily available and utilized.

Access to public transportation to/from VA Mental Health Facilities is extremely important for many veteran patients and their families.

4.2.3. Topography

In addition to limiting the size of the facility footprint, topographical influences may effect the orientation of access points to the facility including the primary entrance, patient access, emergency vehicle and service/staff access. Maintaining accessibility for building egress, walkways, roadways and parking areas will also be impacted by the topography of the site. During the planning phase of the project, consider what the impact of the topography of the site will have on both the functional and aesthetic parts of the design.

During the initial survey of the site, a physical review of the site is recommended. Existing natural features such as mature specimen trees, streams, wetlands and rock outcroppings should influence the location of the facility on the site and the landscape design for the project. Ponds, streams, and wetlands on-site should be inaccessible to unsupervised patients.

At-grade site access from the main entry and patient entry to the facility is essential. On-site grading is an important consideration when planning and locating the access points of the facility.

4.2.4. Zoning

Unlike many general aspects of site design such as roadways and parking aisles, zoning is site specific. Preliminary plans should not advance without performing a zoning analysis. In the case of government-owned property, it is important to consider the zoning and adjacencies for compatibility with neighboring buildings. Factors for zoning include:

- Height

- Lot Occupancy
- Number of Stories
- Parking
- Green Space
- Historic District
- F.A.R.
- Setbacks
- Use Groups

4.2.5. Archeological/Historic Features

Early in the design phase, there should be an analysis which determines whether there are any historic or archaeological issues that will impact the development of the site. As with the zoning restrictions, these issues are site specific. The impact of historic related issues includes: finish of the exterior; window types, colors and shapes; roof types and slopes; color of façade; height of facility and location of facility. Federal, state and local jurisdictions and related agencies should be contacted to assure that the guidelines in place are followed.

4.2.6. Roadways

1. Site Access

Site access roadways will be connected directly to main public roadways. The location of curb cuts and aprons should be planned in accordance with local zoning code or AHJ.

2. On-Site Roadways

Width of roads should accommodate traffic in each direction. A path from the site entrance to entry of the facility should be logical and easily identifiable.

Site roadways to and from parking areas should be capable of accommodating two-way traffic. Proper signage and direction arrows may enhance clarity of destinations and paths.

3. Emergency Roadways

Emergency access is required on the grounds of the facility. This access relates to ambulance, fire and rescue, law enforcement and other emergency related vehicles. The width of the roadway for emergency purposes should be maintained and unobstructed at all times.

A loop road or some means of complete site access is generally required in every jurisdiction. Loop road design should accommodate a fire truck, and enable emergency vehicles to access a complete revolution around the facility. At a minimum, access to every part of the site and facility for emergency vehicles must be provided.

4. Service Road

The service road may better serve the facility by having a separate access point. Should that not prove feasible due to site restrictions or other reasons, consider a separation of roadways upon entry to the site. Clearly indicate the service road and design it in such a way as to not interfere with general site access or emergency roadways. The service roadway should accommodate truck traffic in two directions unless the roadway system is designed and clearly identified as a one-way traffic pattern.

4.2.7. Site Signage/Wayfinding

Locate signage on the site for visitors, patients, staff and service accommodations. Some suggestions for site signage include:

- Directional Traffic (one-way)
- Restrictions
- Parking
- Deliveries
- Patient Entry
- Entrance to Site
- Entrance to Facility

For specific signage criteria, refer to the VA Signage Design Guide, located in the VA Technical Information Library (TIL) found on their website.

4.2.8. Proximity to Adjoining Facilities

A new mental health unit may be co-located with an existing Medical Center campus. In this instance, there may be the opportunity to share, upgrade or expand existing site access and roadways, parking and other site features to the mutual benefit of both facilities.

Compatible adjoining or proximate facility site development should be considered and integrated into the site design of the Mental Health facility to:

- 1.) Maintain or improve existing on-site vehicular movement,
- 2.) Maintain or improve the existing campus exterior aesthetics by the use of consistent landscaping, way-finding and other site features.
- 3.) Create appropriate vehicle and pedestrian connectivity between new and existing facilities.
- 4.) Minimize unnecessary use of resources, site development costs and area of site disruption

4.2.9. Shared Site Features

Location of a new Mental Health facility adjacent to a compatible existing use could allow several possibilities for shared site features and, for example, could impact:

- Siting of facility
- Orientation of entrance
- Location of services
- Access to site
- Availability of utilities

If operationally appropriate, a common service road or a common entrance to the site in general may be possible. Independent access to power, communications, gas, water, and other utilities however is preferable, so the Mental Health Facility can remain on line in the event of outages on the shared campus. Emergency power provisions for the facility should be a part of the planned program due to the needs of the patients and residents.

The advantage of sharing campus amenities include, but are not limited to:

- Access to site
- Use of existing roadways, parking and other infrastructure
- Extension of existing services and utilities
- Access to medical facilities
- Availability of public transportation

Many of these items translate into construction and operational cost savings over the life of the facility.

4.2.10. Utility Access

Site utilities are critical to successful operations. Among the utilities or utility related components requiring site accesses are:

- Electrical service transformers
- Communication services
- Gas lines
- Stormwater management
- Water and sewer utility
- Oil service (if applicable)
- Emergency power (including fuel)
- Power and communications

Wherever possible, dual feeds for some utilities should be provided. The most pronounced of these would be power sources. An attempt should be made to attain a feed to the facility from different substations.

4.2.11. Services

Services areas include:

- Loading docks
- Shipping/receiving areas
- Trash areas
- Vehicular turnaround roadways
- Service ramps

The services for Mental Health facilities are a major component of day-to-day operations. The location of the services are not to conflict with the main entrance to the facility and should be visually screened from the main entrance and patient areas within the facility.

4.2.12. Landscaping

Landscape features provide a major aesthetic benefit to any site or campus. In all but the most urban settings, the landscape provides the first impression of the facility. With regards to Mental Health, landscaping is especially important and is a significant part the overall goal of providing treatment in a therapeutic, residential-like setting. Moreover, visual access to natural elements can promote healing in patients. Existing natural features should be preserved whenever possible and the portion of the site disrupted should be limited to minimal areas outside the building footprint, roadways, parking, walks and utility trenches.

While planning for the landscaping of the site, indigenous vegetation, whether introduced or replaced because of the project, is strongly encouraged to reduce the need for irrigation and pesticides.

4.2.13. Inpatient Exterior Spaces

An essential component to any inpatient mental health facility, MH RRTP and PRRC should be direct, yet secure access to the exterior. Whether courtyard, fenced area or elevated secure screened porch, these contained exterior spaces should; facilitate staff observation, prevent the threat of patient elopement and be designed with hardscape or landscape features that do not support self-harm or assaultive behavior. See Section 3.1.7 for more detailed criteria and illustrations.

4.2.14. Covered Entry

As part of the building and site design, provisions for a covered entrance at the primary access point to the facility and at the ambulance/patient transport access point are recommended. At the primary access point, provide enough roadway width to accommodate a parked vehicle at the entrance while allowing a second vehicle to pass. Height of covered entrance is to be designed to allow clearance

for large emergency vehicles. The ambulance/patient transport covered entry should allow at least one vehicle, including patient loading/unloading to be protected from inclement weather.

4.3. Architecture

4.3.1. Introduction

The previous chapter of this Design Guide describes and illustrates the therapeutic environment VA inpatient, residential and outpatient facilities should have without compromising patient or staff safety and security. In this chapter, some additional technical information is provided to assist in planning and designing a new or renovated mental health facility. This chapter is a general technical overview primarily focused on products and details unique to Mental Health Facilities. Project Teams should refer to appropriate VA Guidelines in the Technical Information Library (TIL) for additional information and clarification.

4.3.2. Exterior Architecture

In new construction projects, whether an addition or a stand alone facility, the exterior architecture serves as the first introduction to the facility for patients, their families and other visitors. As such, it helps to create initial expectations about the facility and the care provided therein. Accordingly, the exterior design should embody a warm, familiar, and home-like design. The scale of the overall facility should be broken down into multiple residential scaled interconnected buildings instead of one large institutional edifice.

4.3.3. Patient and Staff Safety/Security Overview

In The Design Guide for the Built Environment of Behavioral Health Facilities (pg 10) referenced in Section 4.1.2 of this chapter, five interior construction levels are identified. These levels correspond with the types of spaces within a mental health facility particularly an inpatient facility. Level 1 would typically be constructed and up fit similarly to an equivalent health care space. No specific interior finishes, fixtures or devices unique to mental health facilities are required in these areas. At the other end of the spectrum, Level 5 requires construction, finishes, fixtures and devices in rooms that are very specific to a mental health facility. Patients who present unknown potential risks may safely occupy these spaces. Levels 2 through 4 required some specific finishes, fixtures and devices that support patient safety in these spaces depending on their use.

These levels are not part of the VA standards but are used as a reference in this chapter.

Level 1: Staff and Service areas where patients are not allowed.

- Level 2: Counseling rooms, examination rooms, group therapy, multi-purpose and interview rooms where patients are highly supervised and not left alone for periods of time.
- Level 3: Corridors, dayrooms and dining areas- where patients may spend time with minimal supervision
- Level 4: Patient Rooms (semi-private and private) and Patient Toilets- where patients spend a great deal of time alone with minimal or no supervision.
- Level 5: Admissions rooms and seclusion rooms- where staff interacts with newly admitted patients that present unknown potential risks and/or where patients might be in a highly agitated condition.

In Level 4 and 5 spaces nothing in the space, to the fullest extent possible, should facilitate use as an anchor point, weapon, or projectile.

In addition to utilizing appropriate finishes, devices and fixtures, the plan of the facility, particularly inpatient facilities, should allow direct, ongoing observation of patient areas by staff while allowing patients as much freedom as possible to move about independently within the unit or facility.

Technology should be used to support the staff's ability to maintain safety and security for both patients and staff. However, technology should not be used as a replacement for on-going, informal staff observation and interaction with patients.

4.3.4. Interior Wall and Ceiling Construction

Interior Wall Construction- Acoustics: Interior partitions will primarily consist of gypsum board on metal studs. Interior partitions around patient and resident rooms, group therapy rooms and offices should have sound attenuation features such as fiberglass batt insulation between studs. The partitions themselves should extend to the underside of the roof or floor deck above. Some areas may require a double layer of gypsum board in addition to batt insulation to meet the minimum STC requirements required or recommended for that area. Wall penetrations such as doors, interior lights, electrical outlets and mechanical ductwork should be carefully considered and detailed to avoid sound transmission in an otherwise compliant partition system.

Wall Partitions- Abuse Resistance: Level 4 and 5 spaces such as patient rooms and isolation/seclusion suites should utilize abuse resistant gypsum board assemblies to minimize repairs due to patient abuse. United States Gypsum Company (USG) Bulletin SA929 lists five categories of abuse resistant gypsum board systems. It is recommended the gypsum board partition assemblies in inpatient rooms utilize partition hardening recommended in Category 3- Heavy

Duty and the Seclusion/Isolation suite partitions utilize hardening recommended in Category 4- Extreme Duty referenced in the USG Bulletin. Other areas in inpatient units, residential facilities and outpatient facilities that may also benefit from an enhanced gypsum board assembly to reduce maintenance and repair due to abuse should be determined on a facility by facility basis. From a cost standpoint, it is important not to have redundancy. Corridors for example, have handrails, corner guards and high impact panels that provide wall protection and have other functional and aesthetic benefits as well.

Ceilings Construction:

Ceilings in Level 4 and 5 areas such as patient bedrooms, toilets and showers, and isolation/seclusions suites must be gypsum board or another inaccessible and abuse resistant ceiling system. Light fixtures, sprinklers, smoke detectors and any other ceiling mounted devices should be vandal resistant and attached with tamper resistant screws. All ceiling mounted fixtures and devices should be recessed where possible and surface mounted otherwise.

Ceiling construction, in Level 2 and 3 patient areas that are continuously supervised by staff, may be gypsum board or acoustic tile ceilings. Lay-in acoustic ceiling tile systems must be attached with clips to prevent patients from lifting and removing the tiles. Level 3 rooms and spaces that are not continuously observed by staff should use gypsum board ceilings.

4.3.5. Door Construction and Hardware

General: Interior doors should be 1 ¾" [44 mm] thick, solid-core, flush-panel wood doors in hollow metal frames. Stained wood doors are strongly recommended over hollow metal doors for their aesthetic appeal. Hollow metal doors may be used in exterior door applications or service spaces where high impact is a concern.

View Panels: Provide view panels 5" x 20" [127 mm x 508 mm] in all egress doors. View panels in patient room doors allow staff to check on a patient without entering the room but seriously compromise patient privacy. View panels with a lockable hinged door allow patient privacy to be maintained but create a correctional appearance. It is recommended staff open patient doors as required as opposed to view panels in the door. Doors in other patient and staff spaces may have half light glazing to enhance visibility. All glazing used in doors must be laminated glass. Refer to NCPS Guidelines for attack rating requirements for glazing.

General Door Hardware: ADA compliant hardware should be used throughout the Mental Health unit or facility to the extent the hardware does not compromise patient safety. Closers and other hardware that could be used as a weapon

should not be readily accessible to patients. Refer to VA Program Guide 18-14 *Room Finishes, Door and Hardware Schedule* for specific hardware requirements.

Patient Bedroom Door Hardware: Hardware used on inpatient bed room and bathroom doors, as well as doors in rooms where patients may be left unattended, should follow VA hardware guidelines to prevent this hardware from being used as an anchor point. For inpatient door locking criteria refer to page 3-17.

Door hinges: Hospital tip hinges should be used in general applications. For inpatient bedroom and bathroom doors, continuous hinges should be used.

Egress Door Hardware: All inpatient units will be locked under normal operation. Entrances to inpatient units should have an interlocking vestibule to prevent elopement. These doors should have hardware with electronic locks to allow remote unlocking by staff, proximity card access by authorized staff and automatic unlocking in the event of an emergency. Secondary exits shall also have electronic hardware that allows these doors to be automatically unlocked in an emergency.

Staff Door Hardware: Spaces within an inpatient unit, residential unit or outpatient unit that are accessed only by staff such as medication, food service, team conference, clean and soiled utility rooms and staff corridors should be locked under normal operation and with card readers to allow authorized access. The door hardware should allow these doors to close automatically.

Emergency patient room access: Patient bedroom doors in all new construction and renovated construction should swing out. In renovated construction where there is not sufficient egress path clearance, the patient room doors may be in-swinging under normal conditions but must be designed to be opened out in emergency circumstances when a patient has attempted to barricade themselves in the room. There are three options for achieving this, none ideal:

1. Pivot hinge with smoke gasketing: The pivot hinge allows the top of the door to be used as an anchor point.
2. Door within a door: This consists of a smaller door cut into the main door. The hardware consists of a deadbolt lock and continuous hinge that can be opened out in an emergency scenario. This option is aesthetically unattractive and appears to be a retrofit solution.
3. Remove hardware: There are several products on the market that allow doors to be opened out in emergency conditions. However, these products require special tools and/or staff to remove the hardware necessary to open the door in an emergency. When a patient attempts to

barricade themselves in their room, the door needs to be opened immediately.

4.3.6. Windows and Glazing

Glazing: Laminated glazing must be used in all interior glazed openings and on the interior face of exterior windows in all inpatient units where patients have access to the glazing. Laminated glazing should also be provided and on the exterior of exterior windows where the window stool is 6'-6" or less in areas accessed by inpatients, such as courtyards. Laminated glazing is also recommended in residential and outpatient facilities in areas where residents or patients may be left unattended. The thickness of the glazing will depend on the size of the opening. Typically, 5/16" is used in most applications.

Laminated glazing is preferred by the VA as a less costly alternative to glass-clad polycarbonate glazing and a more durable alternative to polycarbonate glazing which can be easily scratched.

One-way mirrored glazing will be utilized in interior applications where an office/control room abuts a treatment or therapy room to be used for observation.

Interior Lights: Interior lights should be installed in painted hollow metal frames with laminated glazing. The glazing thickness and the size of the glazing stop should be based on the size of the light. Tamper resistant screws should be utilized to secure the glass stops.

General Exterior Windows: Windows not in patient rooms or resident rooms may be fixed with insulated double glazing. The interior face of these windows should be laminate glazing. The exterior face should be laminated glazing if the sill is less than 6'-6" and the window opens onto an exterior space accessed by patients.

Patient Room Exterior Windows:

Exterior windows within inpatient units shall be heavy gauge commercial units with insulated double glazing. The interior glazed face shall be 7/16" laminated glass. Patient and resident rooms are required by VA standards to be operable for emergency ventilation. These windows should be able to be locked with a custodial lock with the custodial wrench located at the nurse's station. Operable window openings should not exceed 4" [101.6 mm] to prevent elopement or to allow an unauthorized visitor into the facility. The operable portion of the window should open to the exterior and a security screen should cove the interior of the operable frame. The screen should be attached with tamper resistant screws. All exterior windows in patient bedrooms should have integral blinds.

4.4. Interior Design

4.4.1. Introduction

The primary objective of the interior design of any of the various Mental Health units and facilities is to provide a residential, therapeutic environment. Finishes, fixtures and furnishings that maintain the safety and security of the facility need to be integrated into the interior design without detracting from this primary objective.

A warm, welcoming, and familiar environment can help calm patients and promote their participation in treatment and their rehabilitation and recovery. A warm, therapeutic environment has also been shown to be preferred by staff. The key elements of interior design include:

- Lighting
- Acoustics
- Finishes
- Graphics/Way-finding
- Furnishings

4.4.2. Lighting

Lighting, both natural and artificial, plays an important role in creating a safe and normalized environment. The following natural and artificial lighting considerations should be integrated into the design of a Mental Health facility:

Natural Light (Day-lighting):

Daylight, along with views to the exterior, provides essential sensory stimulation for inpatients, as well as reinforcing the normal rhythm of a typical day.

Accordingly, controlled natural daylight should be maximized in the design.

Specific goals related to day-lighting are:

- Design to provide daylight in all feasible areas in appropriate quantities.
- Distribute daylight uniformly where possible, with no significant dark spots.
- Provide daylight sensitive controls for the artificial lighting fixtures so that they will automatically be turned off when not needed.
- Sun control is essential, but exposed sun control devices such as drapes, blinds and other interior shading devices should be avoided in inpatient group congregate areas wherever possible.
- Avoid sizing or positioning windows or skylights in a manner that would create undesirable heat load and glare causing visual discomfort or visual disability.

Safety/security considerations: Appropriate glazing materials and sun control devices for individual spaces are addressed elsewhere in this Design Guide

Artificial Lighting:

Artificial lighting will be required to supplement day-lit areas at night and light areas without access to daylight. Specific goals related to artificial lighting are:

- Design lighting levels shall be appropriate to the use of the space.
- Provide variable lighting levels in inpatient areas to allow different lighting levels based on the activity and time of day.
- Provide accent lighting, both interior and exterior where appropriate. Interior accent lighting should highlight art work and other feature walls. Exterior accent lighting in spaces viewed from the inpatient unit prevents looking out into a black hole at night.
- While maintaining safety and security is essential, avoid excessive illumination in spaces such as corridors or exterior courtyards that reinforce an institutional image and interfere with normal day/night rhythms.

Safety/security considerations: Light fixtures in areas accessed by patients should be flush mounted in the ceilings, with tamper-resistant frames and break resistant lenses securely fastened to the frame. Wall mounted sconces, pendant lighting and floor or table lamps should not be used in in-patient settings.



Figure 4.4.2.1: Wet/Vandal Down-light



Figure 4.4.2.2: Standard Recessed Fluorescent Fixture

4.4.3. Acoustics

Acoustical design in a mental health facility, unit or clinic is an essential part of the design to preserve privacy/confidentiality and reduce excessive noise. The need for privacy/confidentiality is now mandated under HIPPA as discussed in Section 4.1.4 of this guide. Excessive noise can adversely affect a therapeutic environment by affecting both a patient and staff's ability to hear and be heard in a normal tone of voice and detracting from a calm, non-threatening environment - potentially heightening some patients' fear and anxiety levels.

Sound Transmission:

Reducing or eliminating sound transmission from rooms requiring privacy to adjacent spaces is the most critical acoustic need. The Design Guide plates identify appropriate STC levels but these must be coordinated with adjacent spaces as a part of the design process.

VHA Program Guide-18-3, Topic 11 addresses noise transmission control that may be required based on room adjacencies. As discussed in Section 4.3.4, wall partition construction is the primary means for reducing sound transmission between spaces.

Sound Absorption:

Sound absorption is the next most common acoustic need, especially in areas where patients gather. Interior wall and ceiling finishes can help reduce excessive noise. Sound absorbing wall, floor and ceiling materials should be used where appropriate in corridors, congregate areas and other spaces used by patients. These finishes are described in Section 4.4.4.

4.4.4. Interior Finishes

Key criteria in the selection of interior finishes and materials include:

- Aesthetic value
- Therapeutic attributes
- Maintainability
- Durability
- Affordability
- Infection Control
- Sustainability
- Safety/Security
- Flammability / Flame Spread Compliance

Flooring Finishes:

Flooring in mental health facilities, both inpatient and outpatient, should promote a warm, bright, and healing environment. The flooring material should be secured to the floor, not easily torn or dislodged and free of tripping hazards. Floors with high glare can cause difficulty for psychotic patients and older patients and, therefore, should be avoided.

Resilient Flooring: Rubber flooring, linoleum or sheet vinyl are now manufactured in a variety of attractive patterns and colors, are sustainable, durable and easily maintained. Currently, sheet vinyl is the only resilient flooring available in a wood grain pattern. As part of the stated objective to create a residential feels, this wood grain look is strongly recommended for use in inpatient rooms and units. Other colors and patterns may be used elsewhere in inpatient and outpatient facilities. Vinyl Composition Tile has been previously used by the VA but is not recommended due to the high maintenance cost over the life of the product.

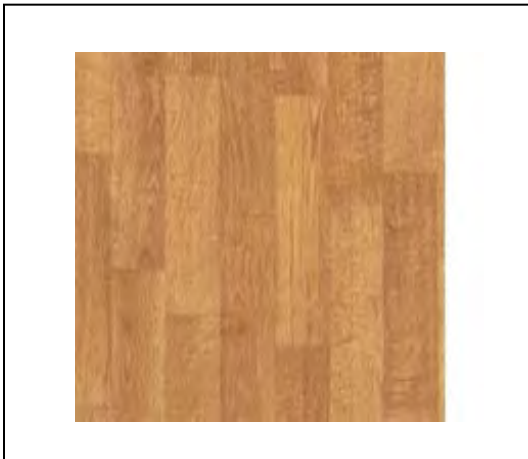


Figure 4.4.4.1: Sheet Vinyl Flooring

Ceramic/Porcelain Tile: Through body porcelain tiles carry the color and pattern through the entire thickness of the tile making them virtually impervious to wear and may be considered for waiting areas and other congregate areas where durability and maintainability are of concern, such as patient dining areas. Ceramic tile, no larger than 2" x 2" [50.8 mm x 50.8 mm], may also be used in inpatient bathrooms for floor surfaces only. The tile should be installed with no exposed edges to prevent a patient from dislodging a tile and using it as a weapon. Porcelain tile or ceramic tile should have a coefficient of friction not less than 0.7 COF.

Carpet: Carpet tile is recommended due to its ability to be replaced. Carpet backing should have an upgraded moisture guard or moisture-

resistant backing system. It is recommended to use backings with a lifetime warranty to protect against de-lamination and edge raveling. Broadloom carpet provides a seamless visual look vs. carpet tile. Carpet tile should be used in supervised patient areas such as group therapy and in staff areas such as conference rooms and office areas.

Epoxy Floor Finishes: This material may be used in seclusion bathrooms but is not recommended in general inpatient bathrooms because of its negative institutional appearance.

Solid Surface Shower Base: Solid surface shower bases in both accessible and non-accessible models allow a durable monolithic shower floor surface that is preferable to ceramic tile in inpatient bathrooms.

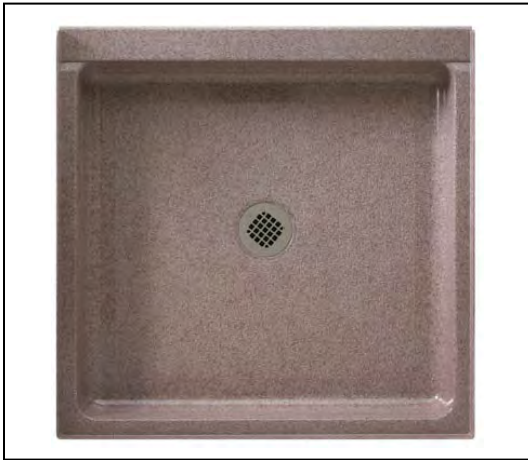


Figure 4.4.4.2: Solid Surface Shower Pan

Floor Base Materials: Rubber cove base is recommended where the flooring material is carpet, carpet tiles, sheet vinyl or rubber. In areas where a more residential look is desired, upgraded rubber bases that simulate wood base is recommended. Where ceramic or porcelain tile is used, the base should match the flooring. Care should be taken that this base can not be easily dislodged by patients.

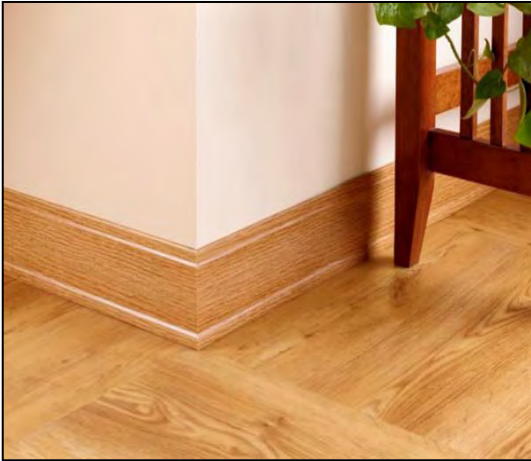


Figure 4.4.4.3: Wood Profile Rubber Floor Base

Thresholds: Thresholds should be avoided wherever possible to prevent tripping hazards and use as a weapon. Where required they should be firmly secured to the floor with tamper resistant fasteners. Thresholds should be no higher than $\frac{3}{4}$ " [19.05 mm] above the floor.

Wall Finishes:

Wall finishes should be durable, easily cleaned and non-toxic.

Wall Finish Including Paint and Vinyl Wallcovering:

Warm paint colors with accent tones should be used in patient rooms and common areas. Vinyl or non-breathable wallcoverings should not be used on exterior walls due to moisture and mold concerns. Wallcovering can be used in public areas to provide texture, pattern, or color to the wall surface. An eggshell paint finish is recommended instead of a flat finish in most applications. Eggshell is easier to clean, maintain, and match when patching. A level 4 finish for drywall is required along with one coat of primer and two top coats of paint. Inpatient bathrooms and patient toilet walls should be painted with epoxy paint.

High Impact Paneling and Trim: High-impact paneling and trim now come in a variety of colors and textures and can provide an aesthetic benefit of creating a wainscot in a corridor, a headboard or miscellaneous trim in a patient room while providing the functional benefit of enhanced impact resistance to walls.



Figure 4.4.4.4: Wainscot Paneling

Wood Paneling and Trim: Wood paneling and trim create a warmer, more residential environment, but should be limited to areas such as reception and waiting areas where this material can not be easily scratched or damaged.

Ceramic Wall Tile: 2" x 2" [50.8 mm x 50.8 mm] ceramic tiles are acceptable for outpatient and resident bathrooms and toilet rooms in mental health facilities where the potential for abuse is minimal. Ceramic wall tile should not be used in inpatient mental health bathrooms and toilets.

Solid Surface Panels: Solid surface panels are recommended in showers for inpatient bathrooms. This material is attractive, durable and easy to maintain.

Corner Guards and other Wall Protection: All edges and corners should be protected by corner guards. When using handrails specify a bracket enclosure preventing an anchor point. Fasteners should be concealed

Acoustic Wall Panels: Acoustic wall panels help absorb sound in areas with mostly hard surfaces. The fabric material of the acoustic panel should be durable and non-absorbent. These panels should be located in areas not easily accessed by patients.

Ceiling Finishes:

Painted Gypsum Board: All gypsum board ceilings shall be painted with an off-white color, eggshell finish.

Acoustic Tile: Ceilings in spaces used by patients that are continuously observed may be acoustic tile, with the tiles clipped in place to the grid. Acoustic tile ceilings facilitate maintenance access above the ceiling provide good sound absorption, and are less costly than gypsum board ceilings. The ceiling height should be higher than standard to inhibit patient access to the ceiling.

Acoustical Plaster: Acoustical plaster is typically between 1" [25.4 mm] and 2" [50.8 mm] thick and can be applied directly to gypsum board ceilings to improve acoustic performance in a space. This material is recommended in inpatient dayrooms and dining areas when gypsum board ceilings are used.

Ceiling Heights: The first line of defense in preventing patients from tampering with the devices recessed in the ceiling is to raise the height of the ceiling to a level where it is difficult for a patient to reach.

Patient areas with hard ceilings should be a minimum of 9 feet high, particularly in areas where patients are not continuously supervised such as patient bedrooms and bathrooms. Patient activity areas should have a minimum ceiling height of 10 feet if acoustic ceiling tiles are used.

4.4.5. Wayfinding & Signage

Wayfinding and signage that allows patients and visitors to navigate to and throughout any mental health unit, clinic or facility with minimal or no assistance is essential. Clear, attractive signage with large contrasting notations is required. All exterior and interior signage must comply with the [VA Signage Design Guide](#) located on the VA's website.

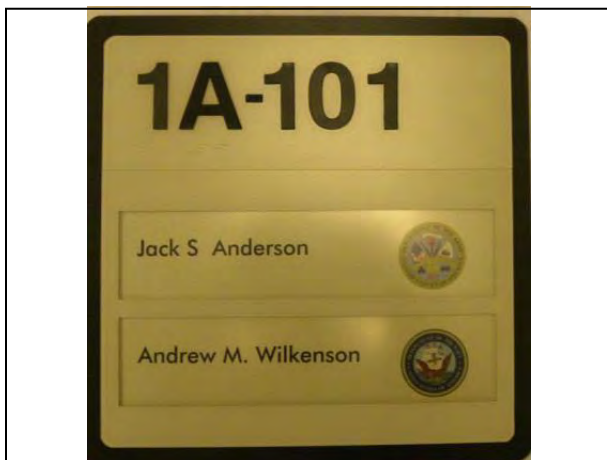


Figure 4.4.5.1: Standard Room Sign



Figure 4.4.5.2: Standard Room Sign

Safety/security considerations: Signage in inpatient units should be attached to walls with concealed tamper resistant fasteners and have beveled edges to prevent the signage from being removed and used as a weapon. No ceiling mounted signage that could be used as an anchor point or weapon should be installed in inpatient units. Signage that is painted on walls may be used in areas susceptible to inpatient abuse. However, these signage solutions do not meet accessibility standards and should be reviewed on a project by project basis.

4.4.6. Wall Mounted Items

Artwork:

Artwork in mental health spaces enhances the goal of creating a normalized, therapeutic environment for patients. Images that reinforce appropriate messages such as hope, dignity, and joy, enhance the healing process. They send a subliminal signal to the patient that his or her well-being is the caregiver's primary concern. In mental health clinics, harsh colors such as black, chartreuse, and orange should be avoided. For the same reason, jagged lines or images with chaotic movement should be avoided. Graphic art that creates optical illusions should never be used.

A resource for artwork that supports the recovery process is NARSAD (National Alliance for Research on Schizophrenia and Depression) Artworks. NARSAD Artworks products showcase museum quality art by talented artists whose lives share or have shared the common bond of mental illness.

Public areas need artwork with the broadest general appeal. Artwork in public corridors should be large, between 26" x 30" [660.4 mm x 762 mm] and 32" x 40" inches [812.8 mm x 1016 mm]. Because mental health facilities often have long, wide corridors, artwork used in these corridors needs to be larger than artwork used in patient units. It is also recommended to hang artwork vertically in corridors. Still life, landscape, black and white, and architecture images are a good choice in corridors as they provide enough interest to look at and then move on. Public dining areas should display tranquil, restful images that can provide relaxation for both staff and visitor.

Safety/security considerations: Artwork should be installed in a manner that mitigates potential use as a weapon. Picture mounted on walls should have heavy duty frames securely fastened to the wall with tamper resistant fasteners. Polycarbonate glazing should be used to protect the artwork. Care should be taken to reduce the opportunity to attach ligatures to the frame or the joint between the top of the frame and the wall. The frame should be beveled to slope away from the wall. The joint and the top should be sealed with a tamper resistant sealant.

Corner Mirrors:

Corner mirrors, where used for observation into blind corners, should be securely fastened to the ceiling and wall with tamper resistant screws. The mirrors themselves should consist of a non-breakable material. New design projects should avoid blind corners that would require these mirrors to be installed.

Bulletin/Marker Boards:

Bulletin or Marker boards should be securely fastened to the walls with tamper resistant screws. No marker trays should be used. Bulletin boards should be used sparingly if at all. Push pins should not be used for attaching items to the board.

Exit Signs, Door Stops, Telephones:

All of these items should be securely fastened to the walls with tamper resistant screws. Exit signs should be wall mounted instead of ceiling mounted wherever possible within an inpatient unit. Telephones should be located in alcoves directly visible from the nursing station. Telephone cords should not be longer than 12" [304.8 mm]. All materials should be resistant to breakage.

Alcohol Hand Cleaning Dispensers:

Alcohol based gels and foams may be consumed by patients and therefore should not be accessible to them. Infection control protocol for hand cleaning should be established without these dispensers located in the areas accessed by inpatients.

4.4.7. Patient Furnishings

Patient furniture, particularly in patient furniture, should be durable, easily maintained, and abuse resistant with tamper proof fasteners. Furniture should not have sharp edges or surfaces that could be used as an anchor point. Chairs used in inpatient dining areas and in patient rooms should be heavy enough to minimize the threat of the chair being thrown or otherwise used as a weapon.

4.5. Structural

Executive Orders 12699 and 12941 require that all new and existing buildings constructed or leased by the Federal Government be seismically safe. The EOs requires that nationally recognized building codes be used for the seismic design and construction of new buildings, and for the seismic safety assessment of existing buildings. For structural systems, International Building Code should be followed.

Typically, inpatient mental health facilities will be classified as Mission Critical Facilities and as such require specialized structural design for blast resistance and prevention of progressive structural collapse. The structural engineer should verify the classification of any proposed mental health facility in the earliest design stages.

Any exposed structure in either interior or exterior areas accessed by patients should not be able to be used as an anchor point.

4.6. Equipment

Casework:

Modular casework storage systems should be chosen for flexibility including re-use applications. Casework systems should be integrated with the space planning to avoid corner installations and filler panels. Reference the VA's casework standard modules when designing casework for a mental health project. Upper cabinets in areas accessed by patients shall be attached to gypsum board soffits. Upper cabinets in areas not accessed by inpatients shall have sloped tops in lieu of gypsum board soffits.

Management Information Systems:

Management Information Systems (MIS) should be planned and designed on an individual facility basis to meet needs. The amount of information that is assembled and distributed through MIS is increasing at a rapid rate and expansion to meet future needs should be considered.

4.7. Heating, Ventilation and Air Conditioning

General:

The HVAC system should comply with the most current version of Department of Veterans Affairs (VA) HVAC Design Manuals for Hospital Projects, VA Design and Construction Procedures, VA Master Construction Specifications and VA Standard Details, where applicable. Deviations from the VA guidelines may be made provided approval is obtained from the VA. Where specific VA requirements are not available or indicated in this document, design criteria from industry standards such as ASHRAE, NFPA, and DOE etc. should be submitted to the VA for review and approval. Exterior HVAC equipment should be located so they are not accessible to inpatients.

Energy Economic Analysis:

The HVAC system should be selected based on an economic analysis performed in compliance with the appropriate standards listed in Section 4.1: Codes & Standards of this guide to determine the most cost effective system for the building over a 20-year life cycle based on a Life-Cycle Cost (LCC) Analysis.

Energy Conservation:

Energy conservation should be emphasized in all aspects of the building design. The building should meet the requirements of the appropriate standards cited in Section 4.1 Codes & Standards of this guide. These energy standards apply to HVAC systems as well as the building envelope, service water heating, lighting and energy management. Certification should be provided to the VA that the building is designed in compliance with the applicable energy conservation provisions.

Exterior Design Conditions:

Exterior design conditions should be based on the most current edition of the ASHRAE Fundamentals Handbook. Summer design conditions should be based on the 0.4 percent dry bulb and wet bulb temperatures indicated under “Cooling db/mwb”. Where cooling towers are applicable, select the cooling tower based on the wet bulb temperature indicated under “Evaporation wb/mdb”. Winter design conditions should be based on the 99.6 percent dry bulb temperature indicated under “Heating dry bulb”. The A/E may recommend more severe outdoor climatic conditions for review and approval by the VA.

Indoor Design Conditions:

Indoor design conditions for each space should be maintained throughout the year. Interior design conditions for all spaces should be maintained in accordance with the most current version of ASHRAE Standard 55. In addition, the conditions shown in Table 4.4 should be maintained.

Supply Air Requirements:

The supply air volume should be established to meet the cooling load requirements of the occupied space. The supply volume should, however, be modified to meet a) minimum air change requirements, or b) maintain proper space pressurization relative to room exhaust requirements. For all air systems, the supply air minimum airflows shall be established to maintain the minimum air change rates. See Table 4.5. In addition, filtration shall be comprised of a minimum 30% efficient pre-filter and 90% efficient after-filters, where filter efficiencies shall be based on the most current version of ASHRAE Standard 52.

Outdoor Air Requirements:

The HVAC design should provide each space with not less than the minimum recommended quantity of ventilation air as indicated in the most current version of ASHRAE Standard 62.1. In addition to the ASHRAE Standard 62.1 requirements, the minimum air changes of outside air shown in Table 3.6 should be required.

Exhaust Air Requirements:

The HVAC design should provide exhaust air to spaces to control the transfer of odors and provide proper room pressurization.

Noise Criteria:

The HVAC design should provide resulting sound levels in occupied spaces not to exceed the levels listed in the Design Guide plates in Section's 5, 6, and 7.

Seismic Requirements:

Where applicable, earthquake resistive design should comply with the most current version of VA Handbook H-18-8, Seismic Design Requirements and the Uniform Building Code. Seismic design also should conform to the most current versions of SMACNA and NUSIG guidelines.

Design Features:

Economizer: Air conditioning systems should be designed to operate below 48 degrees F (9 degrees C) outdoor air temperature without refrigeration. **Perimeter heat:** Provide perimeter heat for bedrooms and other perimeter spaces when the outdoor winter design temperature is 9 degrees F (-12 degrees C) or lower than interior temperature. **Emergency Power:** Emergency power should be provided for, but not limited to, the following equipment/systems:

- All heating water system components (pumps, condensate return pumps, boilers, etc.) where outdoor design conditions are below 20 degrees F (-6 degrees C)
- Automatic temperature control system and components
- Exhaust system serving the isolation suite

Security/Safety Considerations:

Inpatient Room Diffusers: Louvered diffusers should not be used. It is recommended that perforated hole diffusers be used in the ceiling with tamper resistant fasteners. All supplies and returns should be ceiling mounted or wall mounted above 8 feet.

Thermostats: No exposed wall mounted thermostats should be installed in patient areas. Recommend using a duct mounted temperature sensor programmable from a remote control panel. If necessary, an alternative approach would be using a recessed wall mounted aspirating type room thermostat with a tamper resistant perforated cover.

4.8. Plumbing

General:

The plumbing systems should comply with the current version of Department of Veterans Affairs (VA) Plumbing Design Manuals, VA Design and Construction Procedures, VA Master Construction Specifications and VA Standard Details, where applicable. Deviations from the VA guidelines may be made provided approval is obtained from the VA. In addition, the design should meet the requirements of the current version of the International Plumbing Code (IPC) and the National Fire Protection Association (NFPA). Where state or local codes are more stringent than the above requirements, submit criteria to the VA for review and approval.

Shut-off valves are typically located in clusters in secured or authorized areas only. If it is located in an area with patient access, provide tamper resistant access panels to a utility chase. Utility chases requiring access should be no less than 30" [762 mm] wide.

Domestic Water Systems:

Water service should be extended to the building to serve the domestic and fire protection systems. Domestic water should be distributed to the plumbing fixtures and equipment. The system should maintain a maximum velocity and pressure in accordance with the International Plumbing Code and provide water hammer arrestors in accordance with ASSE 1010 for sealed wall installations without access panels. Size and locate arrestors per the Plumbing Drainage Institute (PDI). Secure wall access panels shall be provided to access flush valves and controls.

Provide wall hydrants on each exterior wall as required in the VA Plumbing Design Guide.

A domestic booster pump system should be provided where street pressure is inadequate. Domestic booster system should include three pumps. One pump should be sized for one-third the total demand and the two remaining pumps should be sized for two-thirds of the total demand. Provide alternating control for the pumps as well as a pressurized storage tank. Emergency power should be provided for the domestic booster system.

Provide duplex shell and steam coil central water heaters with the capacity of generating the flow demand at 140 degrees F (60 degrees C) with each heater sized to supply 75% of the demand. The heater discharge temperature, however, should be set for 130 degrees F (54 degrees C). A hot water re-circulating system should be provided. The domestic heating water system also

should be in accordance with the requirements of the most current version of ASHRAE Standard 90.1.

Plumbing Fixtures:

Plumbing fixture types and flow restrictors should be in accordance with the current version of the International Plumbing Code. In addition plumbing fixtures, where required, should comply with the current version of the American with Disabilities Act (ADA) and as per state and Federal requirements.

The following fixture types are recommended for inpatient applications to reduce patient injury, use as an anchor point, or other patient abuse:

Toilets: Combination floor and wall mounted with back outlets (concealed piping). Provide a floor mounted carrier with lag bolts to increase rigidity and secure the fixture to structure. Flush valves should be recessed in the wall and activated by a push button. Pneumatic push buttons with an electronic controller wired to the nurse's station is recommended in inpatient units. This controller monitors usage and can be programmed to shut-off after several frequent usages. Porcelain water closets are recommended for inpatient bathrooms to promote a normal environment. Where high abuse is anticipated, such as in a seclusion bathroom, the water closet fixture shall be porcelain coated stainless steel with integral toilet seat.

Showers: A single lever mixing valve that provides minimal opportunity for hanging risk is recommended in inpatient units. An alternative is a push button/timer that limits the duration of shower. An electronic shower controller wired to nurse's station that monitors duration of shower and can be programmed to shut-off after several frequent usages is recommended. The shower head should be in a fixed position. The hot water temperature should be thermostatically limited to a maximum of 110 degrees F [43.34 ° C]. Shower mixing valve should be detention grade with a pneumatic actuator.

Lavatories: All lavatory waste and piping should be enclosed and not accessible to the patient. Counters should be solid surface with integral sinks. The use of integral faucets with the solid surface lavatory is recommended. Provide a tamper resistant motion sensor or push-button metering faucet to control the water run time. Floor mounted carriers with lag

bolts to increase rigidity and secure the fixture to structure. Provide a secure, tamper resistant strainer with no stop.

Floor Drains: All floor drains shall be fixed strainer with tamper proof security screws and polished edges, for reduced cutting surfaces.

Water Coolers: Electric water coolers shall be recessed stainless steel, with the cooling apparatus recessed in the wall behind a vandal resistant panel.

Sanitary and Storm Drainage Systems:

Provide an adequate number of sanitary and storm drainage connections from the building. Provide a minimum of two connections from each building with a maximum sanitary sewer size of 12-inch [300 mm]. One sanitary connection may be provided if the connection size is 6-inch [150 mm] or less. Maximum allowable storm drain size is 15-inch [375 mm]. Sizing should be based on the most current version of the International Plumbing Code.

Kitchen waste, where applicable, should be provided with a grease removal system. The grease removal can be accomplished by locating a grease interceptor outside of the structure.

Medical Gas and Vacuum Systems:

Medical gas and vacuum systems are not anticipated to be provided in any inpatient mental health, residential or outpatient facilities.

Seismic Requirements:

Where applicable, earthquake resistive design should comply with the most current version of VA Handbook H-18-8, Seismic Design Requirements and the IBC. Seismic design also should conform to the most current versions of SMACNA and NUSIG guidelines.

4.9. Electrical

General:

All exposed electrical devices in patient areas should be vandal resistant and attached with security fasteners. Exterior equipment such as generators and transformers should not be accessible to patients.

Electrical Closets:

Provide separate electrical closets with clearances in accordance with the requirements of the National Electrical Code (NEC). In buildings having multiple floors, stack the closets.

Public Utility Requirements:

Contact servicing agencies and comply with their requirements for electric services. Make necessary submittals to utility companies for approval of equipment to be installed.

Seismic Restraints:

Requirements should be as specified by local codes and ordinances. The work shall comply with detailed provisions required by local authorities having plan check and inspection jurisdiction.

Electrical System Characteristics:

Contact the local electric utility company for the type and availability of service. When possible, multiple utility feeders from separate utility substations should be provided for service redundancy. Three phase, 480/277 volt or 208/120 volt secondary systems are acceptable. A utility owned, pad mounted transformer is preferred for these services. Service entrance equipment should comply with the VA Electrical Design Manual.

Emergency Power:

An emergency generator should be provided as an electrical source for power and lighting during an interruption of the normal electric supply. Where stored fuel is required, storage capacity should permit continuous operation for at least 24 hours. The specific loads and branch circuit arrangement should comply with NEC Article 517 as well as the VA Electrical Design Manual Chapter 4.

Lighting:

Comply with the Illuminating Engineering Society (IES) recommended lighting levels and VA design criteria. Patient and resident rooms should utilize natural light as much as possible. In addition, provide general lighting and night lighting as required. At least one night light fixture in each patient room should be controlled at the room entrance. All light controls in patient areas should be silent. Lighting should comply with the VA Electrical Design Manual Chapter 6. All lighting fixtures used in patient areas should be listed for vandal resistant construction.

Receptacles:

Provide each patient room with non-metallic duplex receptacles which are used for tamper resistant applications and are equipped with ground fault current interrupters. Provide one receptacle at each side of the head of each bed and one on receptacle every other wall. Electrical receptacle cover plates or electrical supplied from the emergency system should be distinctively colored or marked for identification. Ground fault interrupters should comply with NFPA 70. Receptacles should comply with the VA Electrical Design Manual Chapter 3. Outlet plates should have tamper resistant screws.

Conduits:

Conduits should be rigid where used in damp or exposed locations, or where specifically required by the NEC. PVC conduits should be used where routed underground. Electrical metallic tubing should be used in dry concealed locations and furred ceiling spaces. Flexible conduits should be used for final connections to recessed lighting fixtures, to motor driven equipment and vibrating equipment. PVC Schedule 40 conduits should be used for concrete encased feeders. PVC Schedule 80 conduits should be used for direct buried branch circuits. Conduit should not be used as a ground path; all electrical circuits should contain a ground wire. Minimum conduit size should be 0.5 inches [12.7 mm]. No exposed conduit should be used in areas accessible to patients.

Conductors:

Provide copper conductors with 600-volt insulation for low voltage distribution. Conductors No. 8 and larger should be stranded, type THWN. Smaller conductors should be a solid type THHN/THWN. Aluminum conductors are not permitted. Conductors for use in high temperature locations should be insulated as required by the NEC. Minimum size of power conductors should be No. 12.

Fire Alarm System:

Provide fire alarm and detection systems in compliance with NFPA 101 and NFPA 72 as well as VA Fire Protection Design Manual.

4.10. Communications

Telephone:

Within an inpatient unit, cordless telephones, wall mounted telephones near the nursing station or a “hands free” recessed wall mounted phone system located in a phone room should be available for patient’s use. Telephones are not to be installed in patient rooms.

Telephone outlets are typically provided at each staff work station and in each office, conference or meeting room.

Wall outlets are 18” [457.2 mm] AFF and desk outlets are 48” [1219.2 mm] AFF.

Information System:

Information system needs include computer and electrical outlets available at all work stations and decentralized charting locations. Desk or workstation outlets are 48” [1219.2 mm] AFF. Data outlets should also be provided at each supply/medication area to allow for maintain inventory control. A locked, dedicated information systems room should be located outside the inpatient unit. Additionally, data, phone, and electrical outlets should be installed 48” [1219.2 mm] AFF in all group rooms where video-conferencing may be used.

Video-conferencing:

Video-conferencing, also known as “tele-mental health”, should be available in all mental health and behavioral care clinics, facilities, or units to allow for remote communication between patient and mental health professional. Typically, this video-conferencing capability will be installed in a group room or conference room.

VA video-conferencing units use the VA’s IT network for IP-based video-conferencing. The video conferencing units are typically cart-based to allow them to be stored securely when not in use.

Nurse Call:

Nurse call is typically not required in inpatient rooms and bathrooms, but is generally desired in VA mental health inpatient units. The nurse call should consist of a push button in non-accessible patient rooms. In accessible and bariatric patient rooms and bathrooms, a standard nurse call device should be provided or two push buttons, one high and one low, should be provided in the bathroom for these patients. The nurse call cords should be no longer than 12 inches [304.8 mm]. The specific needs for call system locations should be coordinated with the functional design of the patient unit.

Television:

Cable and electrical outlets for television should be located in patient dayrooms. The cords should be less than 12 inches [304.8 mm] in length and placed out of view to prevent abuse from patients. Televisions should be flat screen and flush-mounted securely to the wall.

Public Address:

Public address systems are required for Mental Health facilities for code required fire and life safety communications. The use of a public address system for regular paging or staff communications should be avoided in the Mental Health facility.

Duress Alarm:

A wireless duress alarm system should be provided in inpatient mental health facilities and is recommended for residential and outpatient mental health facilities. Portable duress devices allow staff to discretely request assistance in a potentially threatening situation from any point within the unit or facility. The duress system for a unit should be monitored at the main nursing station and at a remote security post within the facility.

In residential and outpatient mental health facilities, the monitoring should be located at the central reception/security post for the facility. In addition to portable duress alarms, duress push buttons should also be located under the counter of inpatient nursing stations, at reception desks and in mental health professional's offices and exam rooms where appropriate.

For new mental health units or clinics constructed within existing VA facilities, the staff duress provisions should be coordinated with the overall security protocol established in that particular facility.

4.11. Waste Management

General:

All waste storage should be in a locked storage room to prevent patient access to these materials

Medical Waste:

Medical (biohazard) waste may be generated in examination rooms or in patient rooms. This waste will be collected in Sharps containers or other waste bags and transported using specially designated, closed containers to the soiled utility rooms. The waste is held there until it is transported via the loading dock to the medical waste handling facility.

General Waste:

General waste is generated in all spaces and is held in waste containers for collection. It is then collected by cart and transported via the loading dock to the waste handling facility.

Recycling:

Means of sorting, collecting, transporting and disposing of recyclable materials should be analyzed by locality and modified to suit local conditions and practices.

Optional use of disposable and recyclable products is an important design consideration in recycling alternatives that impacts physical space for waste disposal volumes.

Soiled Linen:

Reusable soiled linens are generated in inpatient units, examination rooms, and resident rooms. They should be collected in carts or hampers and stored in a locked soiled utility room until transported to a soiled linen holding room near the loading dock for pick-up.

4.12. Transportation

Patient Transport:

Typically inpatients, outpatients and domiciliary patients arrive at the main entrance via private transportation. Some inpatients may arrive via ambulance to an inpatient facility not physically connected with a VA Medical Center. The main entrance and ambulance/patient entrance should have a covered drop-off area.

Patients are usually accompanied by family or other caregivers. Clear site and facility organization, through the use of directional signage, is required to assist in directing the patient and others to their destination.

Vehicles transporting residents for admission via the emergency entrance should be clearly directed to this location. Convenient access from visitor parking should be provided. Features such as clear access routes, public spaces, landmarks and signage are particularly important in the Mental Health Center to facilitate wayfinding.

Staff:

Staff entry should be separated from patient/visitor and service traffic. Staff facilities, such as locker room, on call rooms, and staff break rooms should be located convenient to the staff entry.

Records:

Patient records are maintained centrally and may be distributed and accessed electronically.

Specimens:

Effective means are necessary for maintaining and transporting specimens to insure quality. In outpatient clinics, a separate specimen collection rooms should be provided for male and female patients.

Pharmaceuticals:

Pharmaceuticals, including narcotics, are transported by pharmacy staff to individual patient units in locked transport containers. Narcotics are delivered to a locked medication cabinet in the medication room.

Material:

Supply traffic (material) should be separated from patient traffic. Clean supplies are transported via supply carts to the clean utility rooms on the individual patient units where supplies are accessed by staff.

Linen:

Delivery of clean linens and removal of soiled linens within an inpatient unit should be separated from resident/visitor traffic where possible. Clean and soiled linen are transported in linen carts.

Sterile Supplies:

Sterile items used in the exam or treatment rooms are transported via dedicated closed carts. Sterile items also may be stored in the clean utility rooms.

Food:

Food prepared by the VA's food service will be prepared remotely and brought to a serving room directly adjacent to inpatient dining in inpatient units and MH RRTP facilities. The food will be brought in bulk on carts served from a steam table in the serving area. This process allows patients to select the food they prefer. All food trays must be stored in the serving room which can be locked when not in use.

Clean and soiled areas and products must be segregated to prevent cross-contamination. Finished products should be transported only a short distance if they are to remain safe for consumption. Food waste will be collected from the serving area and taken to trash collection areas near loading docks where it is disposed according to facility policies.



Department of
Veterans Affairs



Office of Construction &
Facilities Management

Section 5

MENTAL HEALTH & BEHAVIORAL CARE UNITS

MENTAL HEALTH FACILITIES DESIGN GUIDE



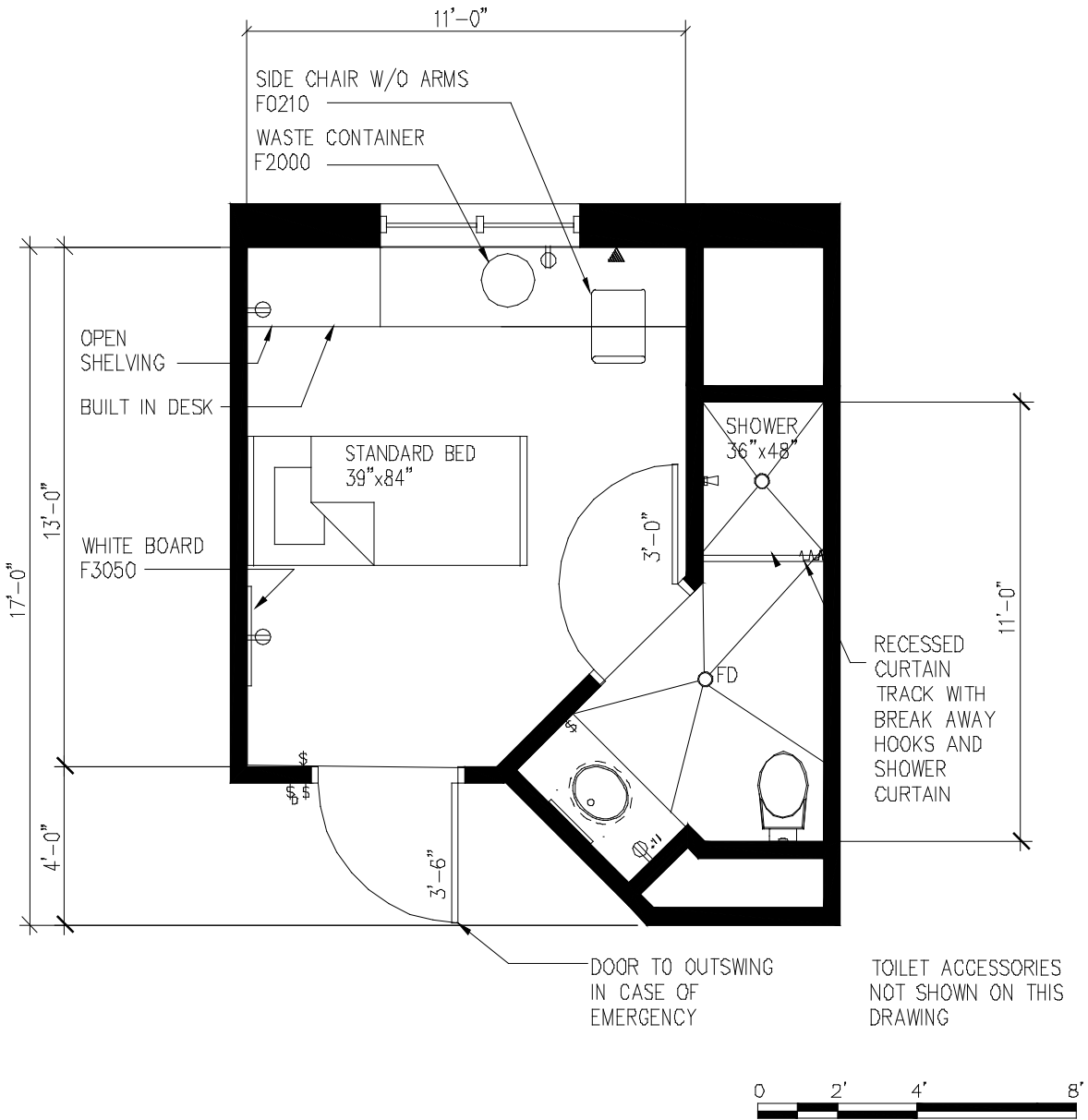
5.0 MENTAL HEALTH & BEHAVIORAL CARE UNITS

General Note: Technical data included in these room templates reflects VA standards at the time this Design Guide was issued. Designers should refer to the latest VA technical documents for updated mechanical, electrical and other criteria that may be at a variance with the data listed in this Design Guide.

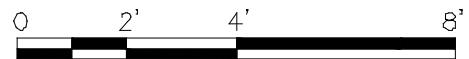
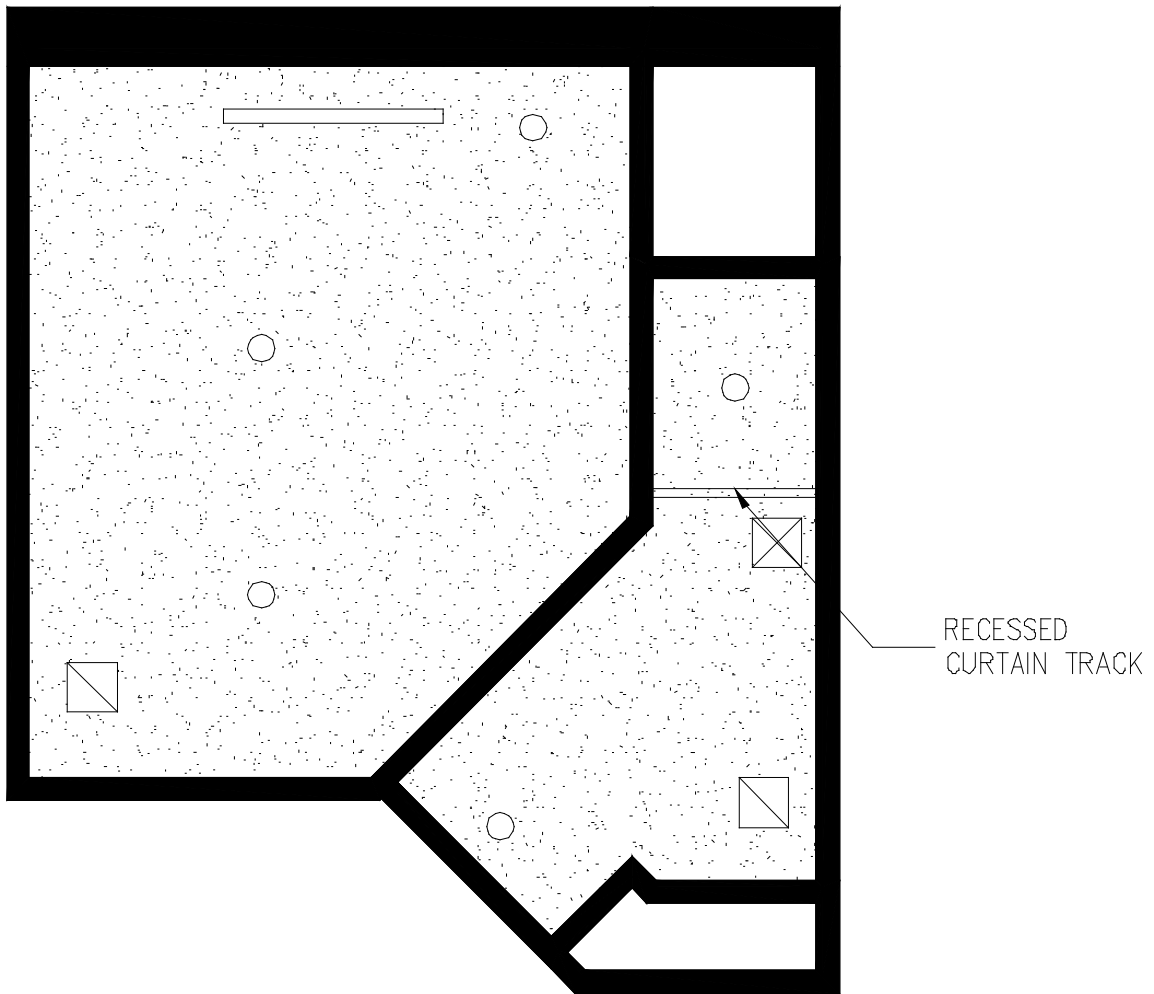
Design Guide Section 5

Design Guide Section No.	Room Name	Room Code	Current Space Criteria NSF [NSM]
5.1	Patient Room, One-Bed, Standard, Inboard Toilet Option	BRNP1	135 NSF [12.5 NSM]
	Bathroom, Patient, Standard	TLTS2	50 NSF [4.7 NSM]
5.1	Patient Room, One-Bed, Standard, Sideboard Toilet Option	BRNP1	160 NSF [14.9 NSM]
	Bathroom, Patient, Standard	TLTS2	50 NSF [4.7 NSM]
5.2	Patient Room, One-Bed, Accessible	BRNP1	150 NSF [13.9 NSM]
	Bathroom, Patient, Accessible	TLTS2	65 NSF [6.0 NSM]
5.3	Patient Room, One-Bed, Bariatric	BRNP1	180 NSF [16.7NSM]
	Bathroom, Patient, Bariatric	TLTS2	75 NSF [7.0 NSM]
5.4	Patient Room, Two-Bed, Standard, Option 1	BRNP2	230 NSF [21.4 NSM]
	Bathroom, Patient, Standard	TLTS2	60 NSF [5.6NSM]
5.4	Patient Room, Two-Bed, Standard, Option 2	BRNP2	230 NSF [21.4 NSM]
	Bathroom, Patient, Standard	TLTS2	60 NSF [5.6NSM]
5.5	Seclusion Suite:		
	Seclusion Room	BRNP5	100 NSF [9.3 NSM]
	Isolation Room		80 NSF [7.4 NSM]
	Anteroom	BRNP6	80 NSF [7.4 NSM]
5.6	Bathroom	TLTS2	65 NSF [6.0 NSM]
	Nurse Suite:		
	Nursing Station	NSTA1	300 NSF [27.9 NSM]
	Nurse Workroom	WRCH1	120 NSF [11.2 NSM]
5.7	Medication / Dispensing Room	MEDP1	150 NSF [14.0 NSM]
	Team Room	CRA01	220 NSF [20.4 NSM]
5.7	Nutrition & Food Service		
	Dining Room	FSCD1	700 NSF [65.0 NSM]
5.8	Serving Line w/ Pantry Storage	FSPT1	235 NSF [21.8 NSM]
	Day Room	DAYR1	675 NSF [62.7 NSM]
5.9	Group Room	OPMH1	225 NSF [20.9 NSM]

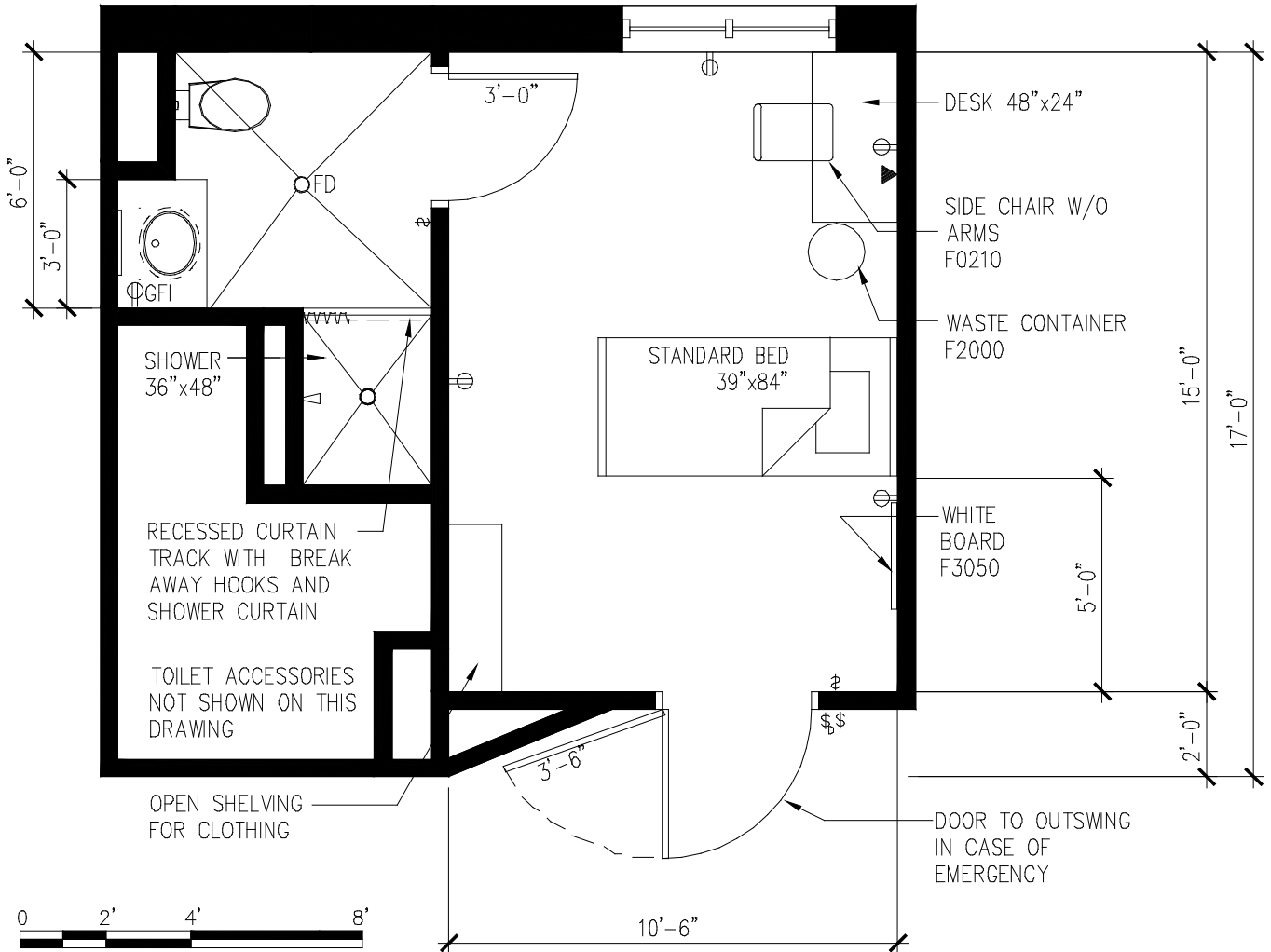
5.1 Patient Room, One Bed, Standard (BRNP1), Inboard Toilet
 Option - 135 NSF [12.5 NSM]
 Bathroom, Patient, Standard (TLTS2) - 50 NSF [4.7 NSM]
 Floor Plan



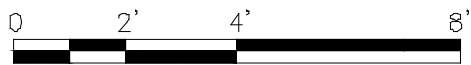
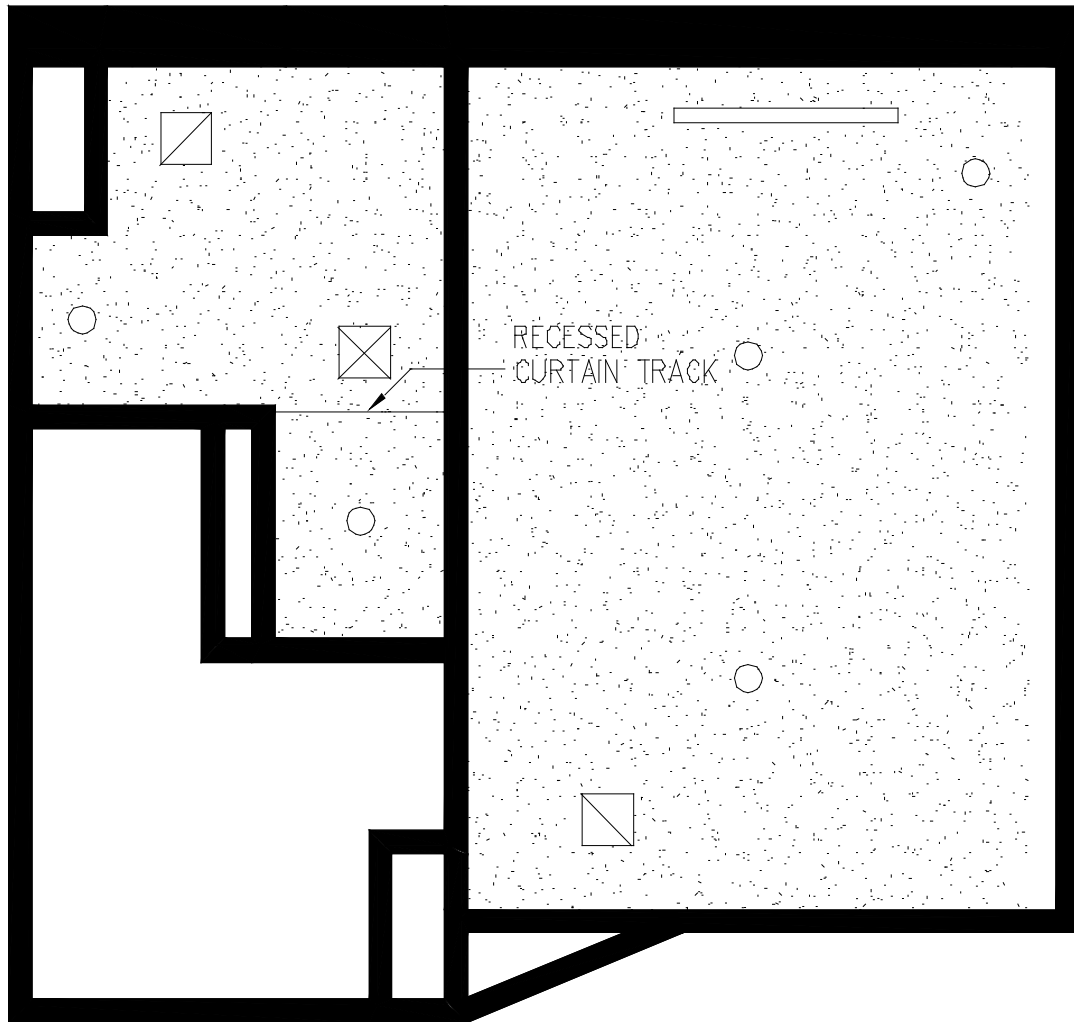
5.1 Patient Room, One Bed, Standard (BRNP1), Inboard Toilet
Option - 135 NSF [12.5 NSM]
Bathroom, Patient, Standard (TLTS2) - 50 NSF [4.7 NSM]
Reflected Ceiling Plan



5.1 Patient Room, One Bed, Standard (BRNP1), Sideboard
 Toilet Option - 135 NSF [12.5 NSM]
 Bathroom, Patient, Standard (TLTS2) - 50 NSF [4.7 NSM]
 Floor Plan



5.1 Patient Room, One Bed, Standard (BRNP1), Sideboard
Toilet Option - 135 NSF [12.5 NSM]
Bathroom, Patient, Standard (TLTS2) - 50 NSF [4.7 NSM]
Reflected Ceiling Plan



5.1 Patient Room, One Bed, Standard (BRNP1) Bathroom, Patient, Standard (TLTS2)

Function:

Single bed patient rooms comprise 50% of the bed space of a typical inpatient unit. The patient room and adjoining bathroom illustrated in this guide plate are referred to as “standard” rooms and do not meet accessibility requirements. A minimum of 20% of the total bed space in a patient unit should be accommodated in accessible bedrooms with adjoining accessible bathrooms. All the accessible bed space in a unit should be contained in single occupancy rooms. These patient rooms are designed to accommodate a variety of mental health in-patient classifications for operational flexibility and simplicity.

Note: Where VA standard items are shown, non-institutional & sustainable options should be considered if feasible.

Space Requirement:

Patient Room, One Bed, Standard Inboard Toilet Option: 135 NSF [12.6 NSM]

Patient Room, One Bed, Standard Sideboard Toilet Option: 160 NSF [14.9 NSM]

Bathroom, Patient, Standard: 50 NSF [4.7 NSM]

Patient Room

Architectural:

Floor Finish:	Sheet vinyl, linoleum or rubber flooring
Base:	Rubber Base (Upgraded rubber base with molding profile recommended)
Wall Finish:	Impact Resistant Gypsum Board, painted finish
Ceiling:	Gypsum Board, painted finish
Ceiling Height:	10'-8" new construction, 9'-0" minimum
Noise (STC Rating):	40 STC
Hardware:	Refer to Sections 3 and 4 in the Guide.
Doors:	3'-6" x 7'-0" wood with view panel.
Windows:	Required by code, see PG-18-3, Topic 1, Codes and Standards. Window unit shall have integral blinds for sun control located between layers of glazing. Inside layer shall be laminated glass. If operable, window unit must not open more than 4 inches.

HVAC:

Inside Design Conditions:	70 degrees F (21C), 75 degrees F (24C) 30% - 50% Relative Humidity
Min. Supply Air Change/ Hr.:	6 .
Return Air:	Permitted
Exhaust Air:	Through connecting toilet
Room Noise Level:	NC 35
Individual Temperature Control:	Required
Room Air Balance:	Positive with respect to toilet, neutral with respect to corridor

Electrical:

Lighting Levels:	
Gen. Illumination:	30 fc (Fluorescent recessed cans with full plastic cover and secure fasteners)
Task Illumination:	75 fc at bed
Emerg. Illumination:	Provide one emergency light

Night Illumination:	Low level lighting for wayfinding to the bathroom. Ceiling mounted night light at entrance of patient bed room, controlled at exterior entrance
Emergency Power:	Provide one source
Telecommunications:	Yes
Medical Gases:	Not Applicable
Receptacles:	4 duplex per room and shall be tamper-resistant or equipped with ground-fault circuit interrupters (GFCI's)
Nurse Call:	Not required. If provided, cord length shall be 12" maximum

Bathroom**Architectural:**

Floor Finish:	2 x2 ceramic tiles. Shower pan may be ceramic tile or pre-manufactured solid surface basin.
Base:	Rubber Base
Wall Finish:	Epoxy Painted Gypsum Board. Solid Surface panels securely applied in shower areas
Ceiling:	Gypsum Board with Epoxy Paint
Ceiling Height:	10'-8" (New Construction) 9'-0" minimum
Noise (STC Rating):	40 STC
Slab Depression:	3" depression for sloping ceramic tile floor
Hardware:	Based on door option selected
Doors:	Wood door with sloped top set in 3'-0" x 7'-0" frame or other options - See Section 3.
Windows:	None

HVAC:

Inside Design Conditions:	Conditioned by make-up air
Min. Supply Air Changes/Hr.:	Not Applicable
Return Air:	Not Permitted
Exhaust Air:	Highest of 10 air changes per hour, 50 CFM or Room air balance.
Room Noise Level:	NC 35
Individual Room Temp. Control:	Not required
Room Air Balance:	Double negative

Electrical:

Lighting Levels:	
Gen. Illumination:	30 fc (Fluorescent recessed cans with full plastic cover and secure fasteners)
Task Illumination:	N/A
Night Illumination:	Low level lighting for wayfinding. Ceiling mounted night light at entrance of bathroom, controlled at exterior entrance
Emerg. Illumination:	Provide one source
Emergency Power:	Not Applicable
Receptacles:	1 GFCI
Nurse Call:	Not required, if provided, cord length should be 12" maximum.

5.1 Patient Room, One Bed, Standard (BRNP1) Bathroom, Patient, Standard (TLTS2)

Equipment Table:

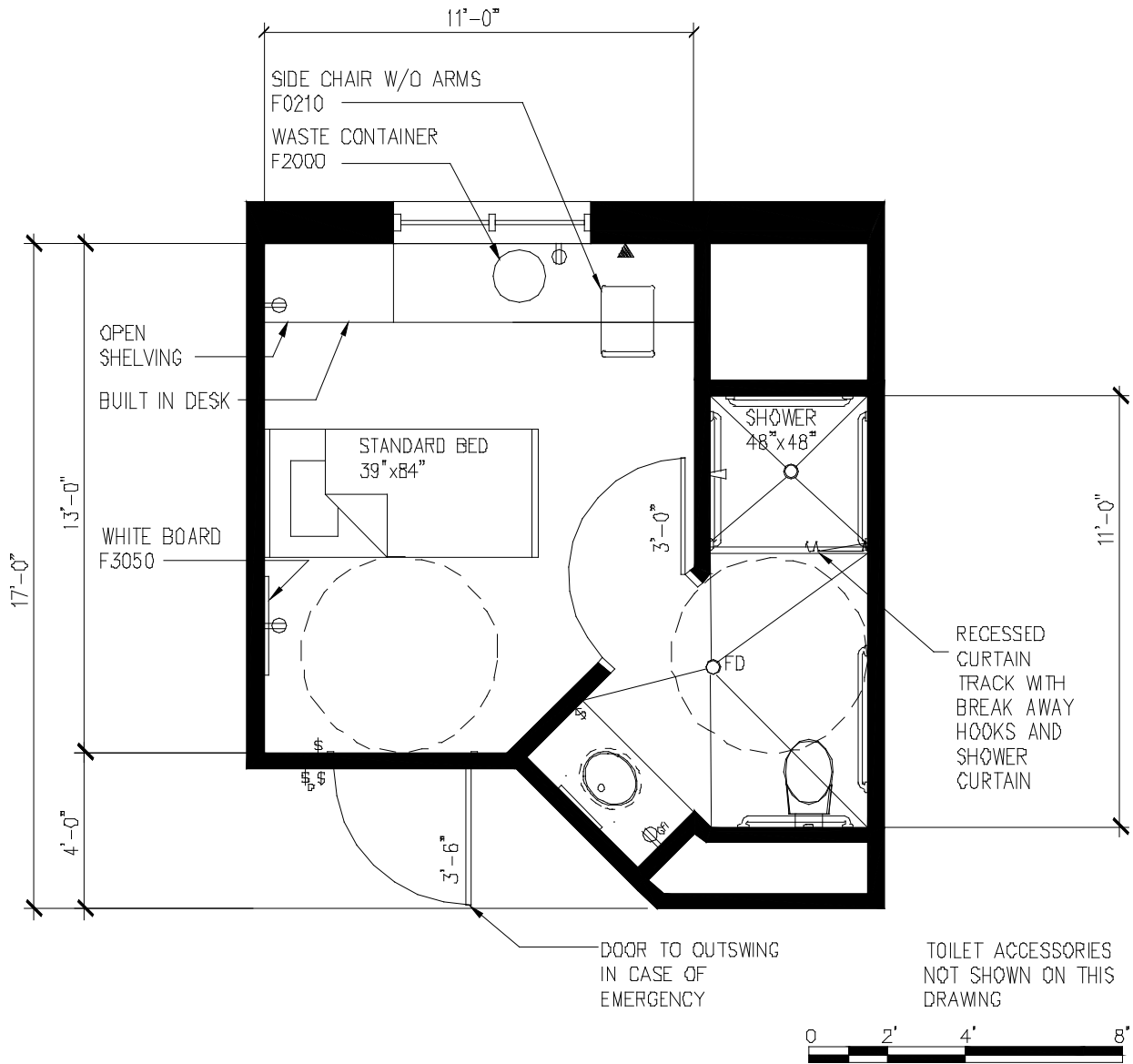
See Legend of Symbols in Section 1.6

SYMBOL	QUANTITY	AI	DESCRIPTION
			Note: Where VA standard items are shown, non-institutional & sustainable options should be considered if feasible.
JSN M7011	1	VV	BED, PLATFORM WITH MATTRESS, 1015mm x 2106mm x 457mm (40"w x 83"l x 18"h)
NO JSN	1	CC	BUILT IN PATIENT DESK, SOLID SURFACE COUNTER 913mm x 609mm x 761mm (36"w x 24"d x 30"h)
JSN F0210	1	VV	CHAIR, SIDE- NON-TILTING, NO ARMS, UPHOLSTERED 812mm x 482mm x 584mm (32"h x 19"w x 23"d)
JSN F2000	1	W	WASTE CONTAINER - PLASTIC 457mm x 406mm dia. (18" h x 16"dia.)
JSN F3050	1	CC	WHITE PORCELAIN MARKER BOARD MOUNTED TO WALL WITH SECURE FASTENERS
NO JSN	1	VV	OPEN SHELVING FOR PATIENT CLOTHING- SOLID SURFACE TOP 1218mm x 457mm x 761mm (48"w x 18"d x 30"h).
			BATHROOM, PATIENT (TLTP2):
JSN P9400	1	CC	TOILET, BACK SPUD PUSH BUTTON FLUSH VALVE, SEAT WITH OPEN FRONT AND CHECK HINGE
NO JSN	1	CC	SAFETY TOILET TISSUE DISPENSER WITH SOFT SPINDLE
NO JSN	1	CC	VANITY, SOLID SURFACE COUNTER TOP, MOLDED SELF EDGE AND BACKSPLASH; INTEGRAL LAVATORY
JSN A5075	1	W	DISPENSER, SOAP, DISPOSABLE
JSN A1066	1	CC	MIRROR, STAINLESS STEEL FRAME WITH PLEXIGLASS 457mm x 914mm (18"w x 36"h)
JSN U5080	1	CC	PAPER TOWEL DISPENSER, SATIN FINISH STAINLESS STEEL, SINGLE-FOLD, RECESSED
	1	CC	SHOWER: SOAP DISH, RECESSED
	1	CC	PSYCHIATRIC PATIENT SHOWER CONTROLS
JSN U5145	3	CC	TOWEL HOOKS, COLLAPSIBLE STAINLESS STEEL
	1	CC	CURTAIN TRACK, RECESSED
	1	CC	CURTAIN – SHOWER (BREATHABLE) WITH COLLAPSIBLE HOOKS
JSN F2000	1	W	WASTE CONTAINER - PLASTIC 457mm x 406mm dia. (18" h x 16"dia.)

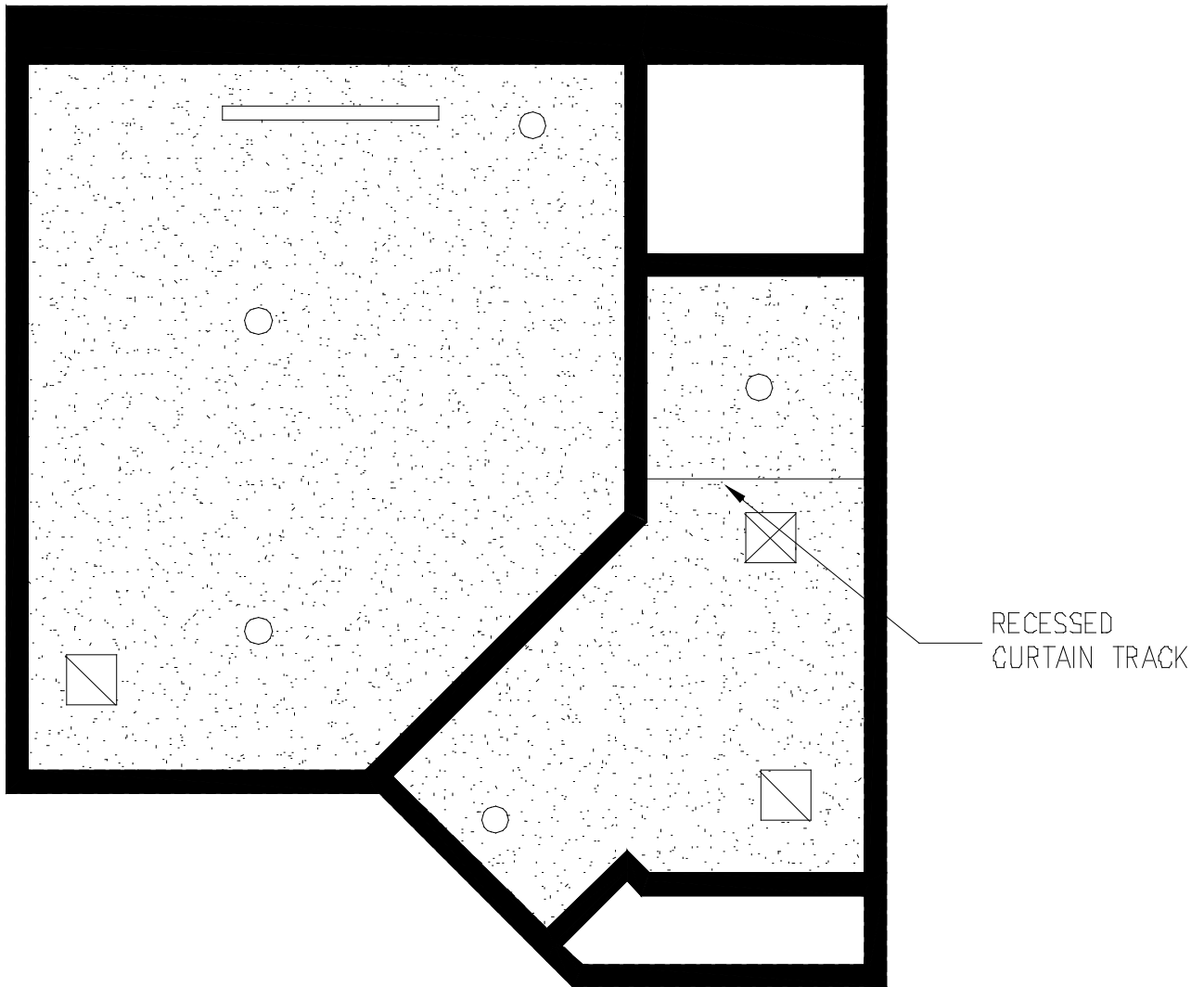
Table 5.1

Patient Room, One Bed, Standard/Bathroom, Patient, Standard

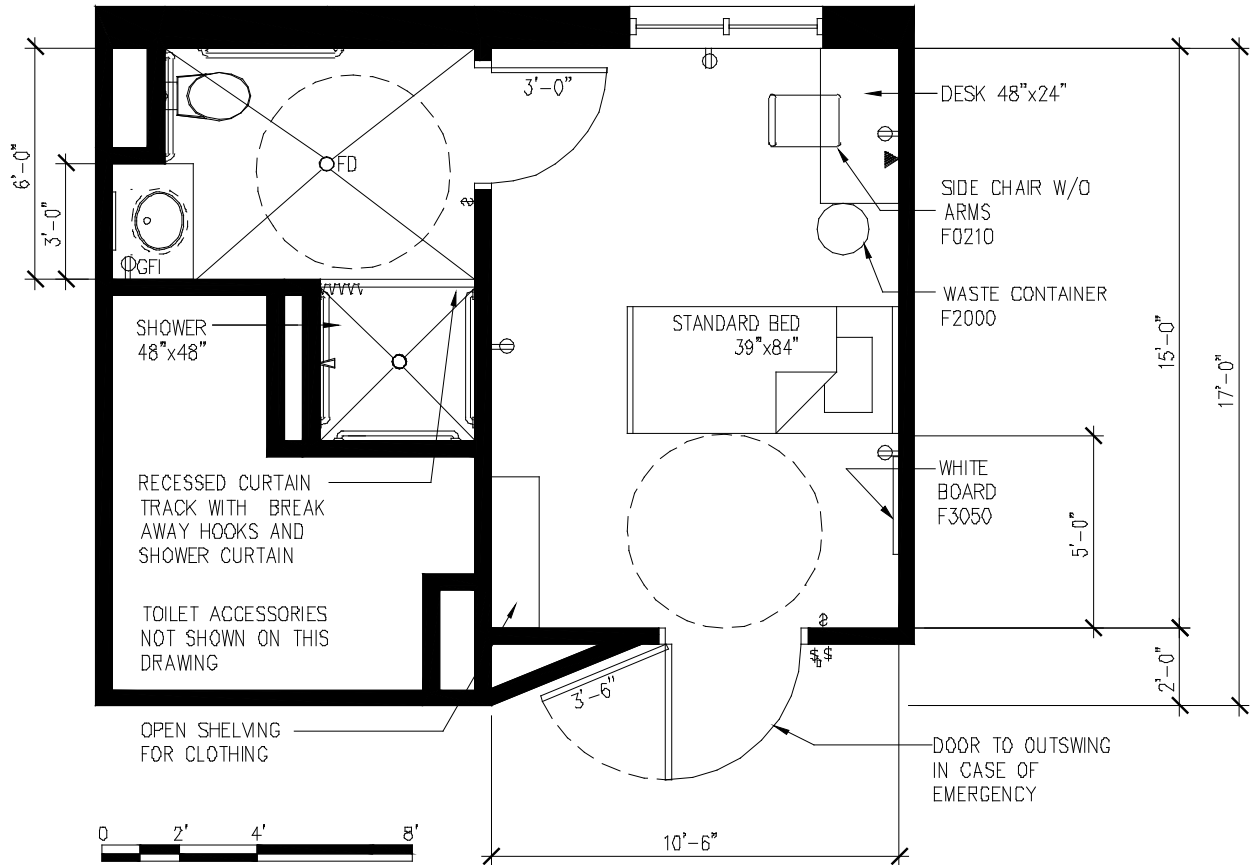
5.2 Patient Room, One Bed, Accessible, Inboard Toilet Option
(BRNP1) - 135 NSF [12.5 NSM]
Bathroom, Patient, Accessible (TLTS2) - 65 NSF [6.0 NSM]
Floor Plan



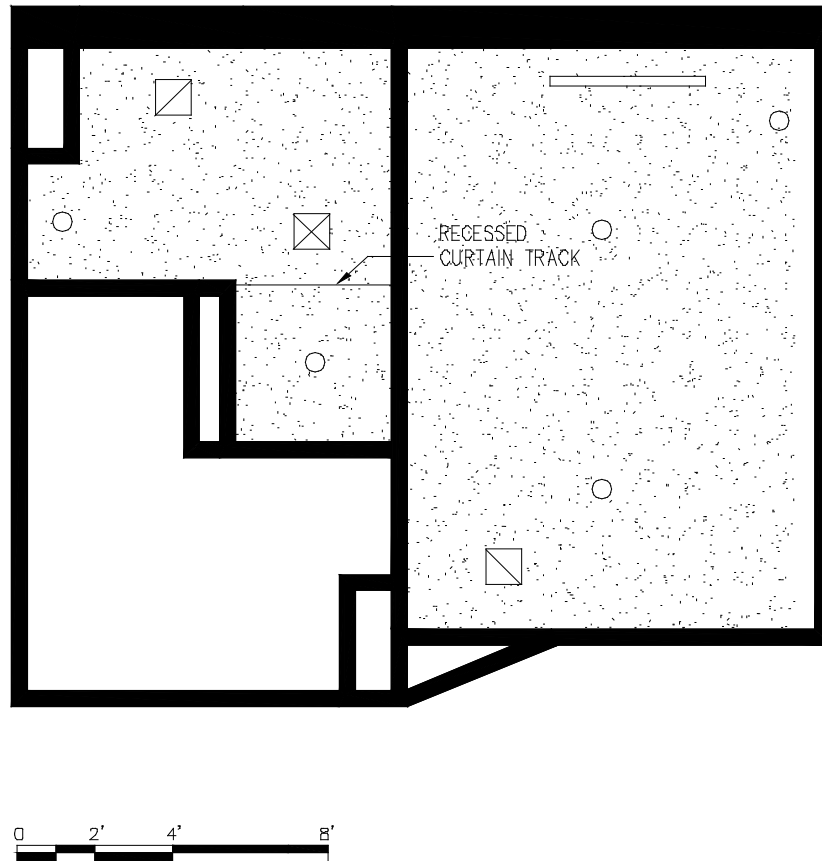
5.2 Patient Room, One Bed, Accessible, Inboard Toilet Option
(BRNP1) - 135 NSF [12.5 NSM]
Bathroom, Patient, Accessible (TLTS2) - 65 NSF [6.0 NSM]
Reflected Ceiling Plan



5.2 Patient Room, One Bed, Accessible, Sideboard Toilet Option
(BRNP1) - 160 NSF [14.9 NSM]
Bathroom, Patient, Accessible (TLTS2) - 65 NSF [6.0 NSM]
Floor Plan



5.2 Patient Room, One Bed, Accessible, Sideboard Toilet Option
(BRNP1) - 160 NSF [14.9 NSM]
Bathroom, Patient, Accessible (TLTS2) - 65 NSF [6.0 NSM]
Reflected Ceiling Plan



5.2 Patient Room, One Bed, Accessible (BRNP1) Bathroom, Patient, Accessible (TLTS2)

Function:

Single bed patient rooms comprise 50% of the total bed space of a typical inpatient unit. 20% of the total bedspace must be accessible and all of the accessible bedspace must be in single occupancy rooms as illustrated in this guide plate. The accessible patient rooms are the same size as the standard patient rooms but the bathrooms are larger.

Note: Where VA standard items are shown, non-institutional & sustainable options should be considered if feasible.

Space Requirement:

Patient Room, One Bed, Standard Inboard Toilet Option: 135 NSF [12.6 NSM]

Patient Room, One Bed, Standard Sideboard Toilet Option: 160 NSF [14.9 NSM]

Bathroom, Patient, Accessible: 65 NSF [6.0 NSM]

Patient Room

Architectural:

Floor Finish:	Sheet vinyl, linoleum or rubber flooring
Base:	Rubber Base (Upgraded rubber base with molding profile recommended)
Wall Finish:	Impact Resistant Gypsum Board, painted finish
Ceiling:	Gypsum Board, painted finish
Ceiling Height:	10'-8" new construction, 9'-0" minimum
Noise (STC Rating):	40 STC
Hardware:	Refer to Sections 3 and 4 in the Guide.
Doors:	3'-6" x 7'-0" wood with view panel.
Windows:	Required by code, see PG-18-3, Topic 1, Codes and Standards. Window unit shall have integral blinds for sun control located between layers of glazing. Inside layer shall be laminated glass. If operable, window unit must not open more than 4 inches.

HVAC:

Inside Design Conditions:	70 degrees F (21C), 75 degrees F (24C) 30% - 50% Relative Humidity
Min. Supply Air Change/ Hr.:	6
Return Air:	Permitted
Exhaust Air:	Through connecting toilet
Room Noise Level:	NC 35
Individual Temperature Control:	Required
Room Air Balance:	Positive with respect to toilet, neutral with respect to corridor

Electrical:

Lighting Levels:	
Gen. Illumination:	30 fc (Fluorescent recessed cans with full plastic cover and secure fasteners)
Task Illumination:	75 fc at bed
Emerg. Illumination:	Provide one emergency light
Night Illumination:	Low level lighting for wayfinding to the bathroom. Ceiling mounted night light at entrance of patient bed room, controlled at exterior entrance

Emergency Power: Provide one source
 Telecommunications: Yes
 Medical Gases: Not Applicable
 Receptacles: 4 duplex per room and shall be tamper-resistant or equipped with ground-fault circuit interrupters (GFCI's)
 Nurse Call: Not required. If provided, cord length shall be 12" maximum

Bathroom

Architectural:

Floor Finish: 2 x2 ceramic tile. Shower pan may be ceramic tile or pre-manufactured solid surface basin.
 Base: Rubber Base
 Wall Finish: Epoxy Painted Gypsum Board. Solid Surface panels securely applied in shower areas
 Ceiling: Gypsum Board with Epoxy Paint
 Ceiling Height: 10'-8" (New Construction) 9'-0" minimum
 Noise (STC Rating): 40 STC
 Slab Depression: 3" depression for sloping ceramic tile floor
 Hardware: Based on door option selected
 Doors: Wood door with sloped top set in 3'-0" x 7'-0" frame or other options - See Section 3.
 Windows: None

HVAC:

Inside Design Conditions: Conditioned by make-up air
 Min. Supply Air Changes/Hr.: Not Applicable
 Return Air: Not Permitted
 Exhaust Air: Highest of 10 air changes per hour, 50 CFM or Room air balance.
 Room Noise Level: NC 35
 Individual Room Temp. Control: Not required
 Room Air Balance: Double negative

Electrical:

Lighting Levels:
 Gen. Illumination: 30 fc (Fluorescent recessed cans with full plastic cover and secure fasteners)
 Task Illumination: N/A
 Night Illumination: Low level lighting for wayfinding. Ceiling mounted night light at entrance of bathroom, controlled at exterior entrance
 Emerg. Illumination: Provide one source
 Emergency Power: Not Applicable
 Receptacles: 1 GFCI
 Nurse Call: Not required, if provided, cord length should be 12" maximum.

5.2 Patient Room, One Bed, Accessible (BRNP1) Bathroom, Patient, Accessible (TLTS2)

Equipment Table:

See Legend of Symbols in Section 1.6

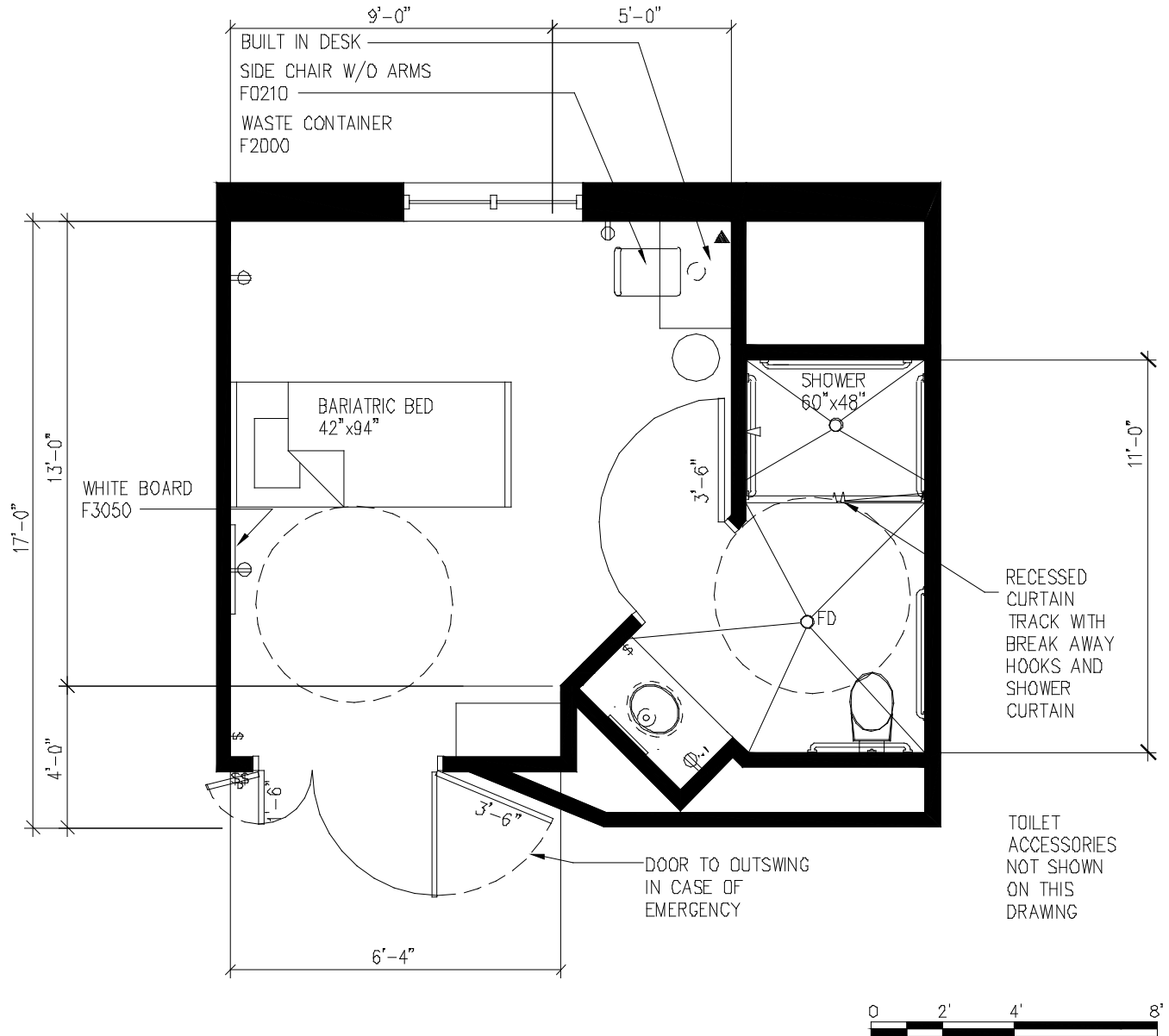
SYMBOL	QUANTITY	AI	DESCRIPTION
			Note: Where VA standard items are shown, non-institutional & sustainable options should be considered if feasible.
JSN M7011	1	VV	BED, PLATFORM WITH MATTRESS, 1015mm x 2106mm x 457mm (40"w x 83"l x 18"h)
JSN F0210	1	VV	CHAIR, SIDE- NON-TILTING, NO ARMS UPHOLSTERED 812 mm X 482mm X 584mm (32"h x 19"w x 23"d)
NO JSN	1	CC	BUILT IN PATIENT DESK- SOLID SURFACE COUNTER 913mm x609mm x 761mm (36"x 24"d x 30"h)
NO JSN	1	CC	OPEN SHELVING FOR PATIENT CLOTHING STORAGE – SOLID SURFACE COUNTER 1218mm x 457mm x 761mm (48"w x 18"d x 30"h)
JSN F2000	1	W	WASTE CONTAINER - PLASTIC 457 mm x 406mm dia. (18"h x 16" dia.)
JSN F3050	1	CC	WHITE PORCELAIN MARKER BOARD MOUNTED TO WALL WITH SECURE FASTENERS
			BATHROOM, PATIENT (TLTS2):
JSN P9400	1	CC	TOILET, BACK SPUD PUSH BUTTON FLUSH VALVE, SEAT WITH OPEN FRONT AND CHECK HINGE
JSN A5109	AR	CC	GRAB BAR 1-1/4" DIA., SS, WALL, WITH PLATE BETWEEN WALL AND BAR FOR WATER CLOSET
JSN A5200	1	CC	SAFETY TOILET TISSUE DISPENSER WITH SOFT SPINDLE
NO JSN	1	CC	VANITY, SOLID SURFACE COUNTER TOP, MOLDED SELF EDGE AND BACKSPLASH; INTEGRAL LAVATORY
JSN A5075	1	W	DISPENSER, SOAP, DISPOSABLE
JSN A1085	1	CC	MIRROR, STAINLESS STEEL FRAME WITH PLEXIGLASS, 457mm x 914mm (18"w x36"h)
JSN U5080	1	CC	PAPER TOWEL DISPENSER, SATIN FINISH STAINLESS STEEL, SINGLE-FOLD, RECESSED
JSN U5145	3	CC	HOOKS, COLLAPSIBLE STAINLESS STEEL
	1	CC	PSYCHIATRIC PATIENT SHOWER CONTROLS
	1	CC	SHOWER: SOAP DISH, RECESSED
JSN A5110	AR	CC	GRAB BAR 1-1/4" DIA., SS, WALL, WITH PLATE BETWEEN WALL AND BAR FOR SHOWER
	1	CC	CURTAIN TRACK, RECESSED
	1	CC	CURTAIN – SHOWER (BREATHABLE) WITH COLLAPSIBLE HOOKS

SYMBOL	QUANTITY	AI	DESCRIPTION
JSN F2000	1	W	WASTE CONTAINER, PLASTIC 457mm x 406mm (18" high X 16" dia.)

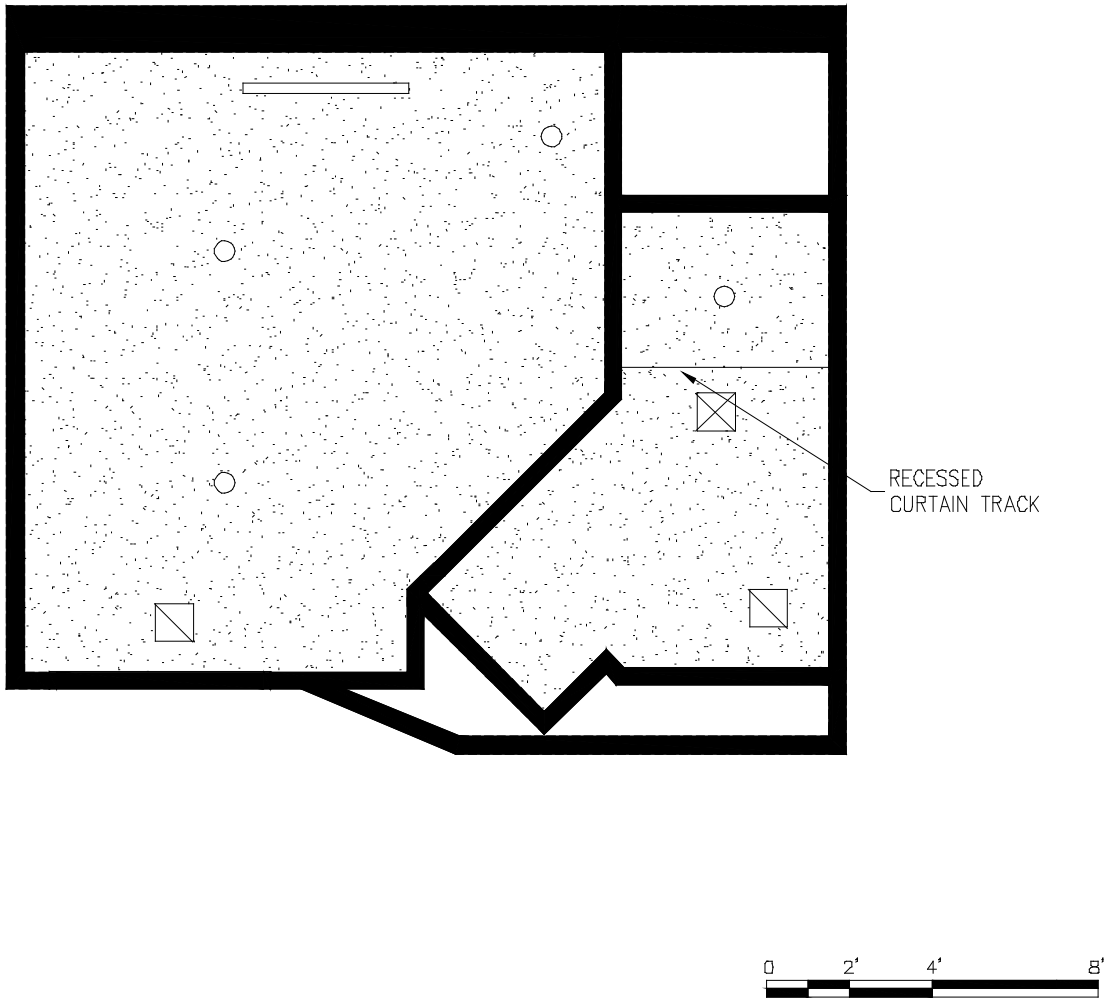
Table 5.2

Patient Room, One Bed, Accessible / Bathroom, Patient, Accessible

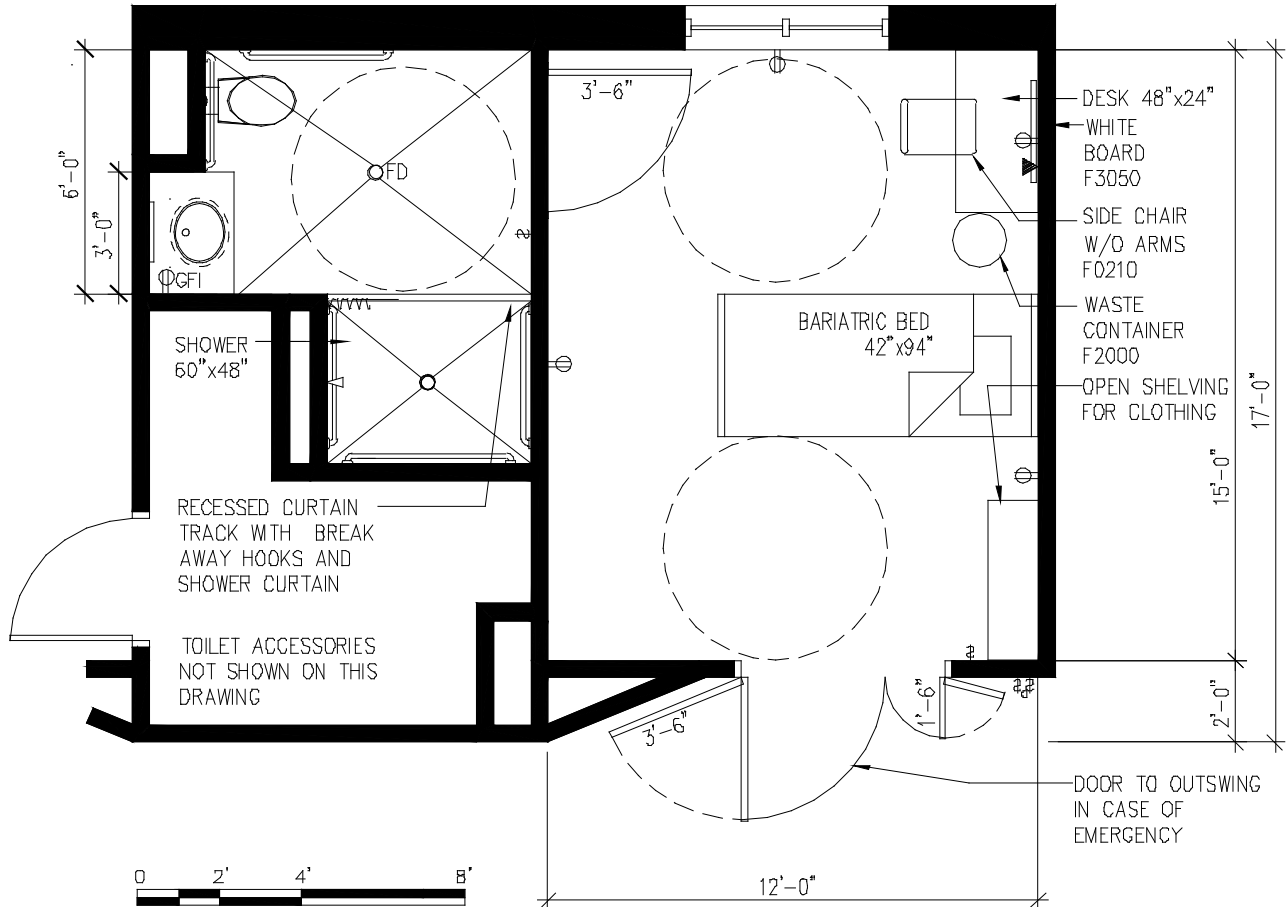
5.3 Patient Room, One Bed, Bariatric, Inboard Toilet Option
 (BRNP1) - 180 NSF [16.7 NSM]
 Bathroom, Patient, Bariatric - (TLTS3) - 75 NSF [7.0 NSM]
 Floor Plan



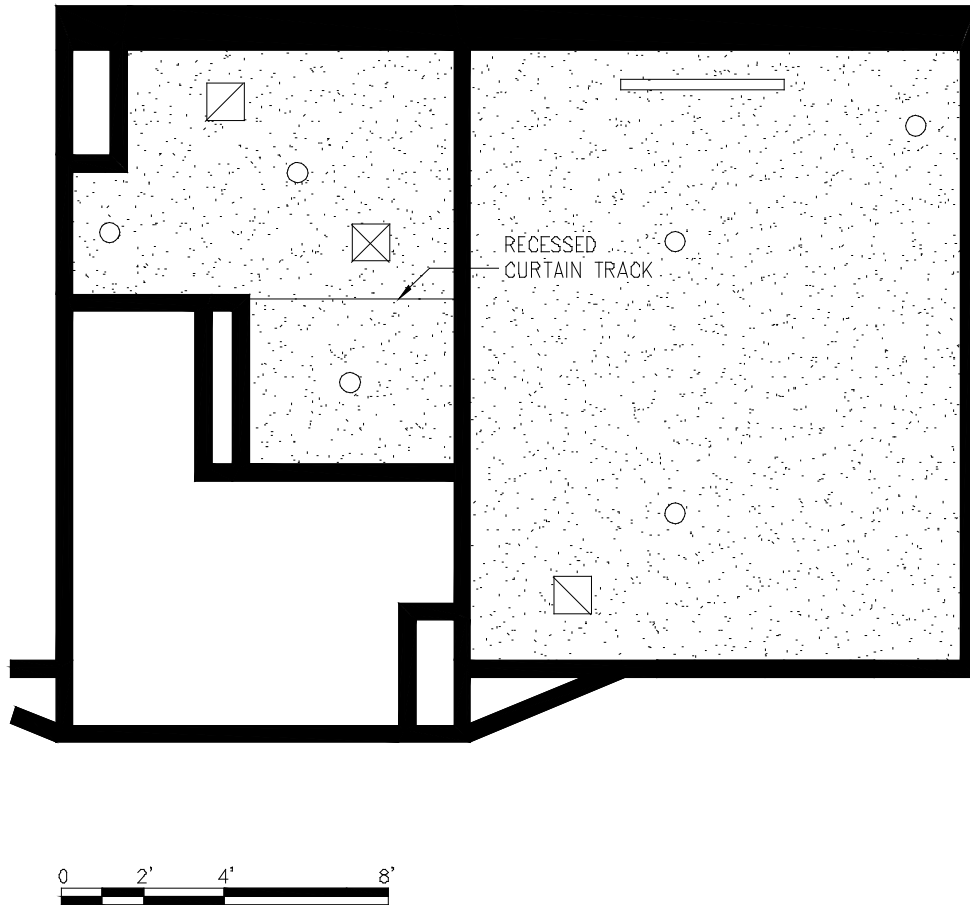
5.3 Patient Room, One Bed, Bariatric, Inboard Toilet Option
(BRNP1) - 180 NSF [16.7 NSM]
Bathroom, Patient, Bariatric - (TLTS3) - 75 NSF [7.0 NSM]
Reflected Ceiling Plan



5.3 Patient Room, One Bed, Bariatric, Sideboard Toilet Option
(BRNP1) - 180 NSF [16.7 NSM]
Bathroom, Patient, Bariatric - (TLTS2) - 75 NSF [7.0 NSM]
Floor Plan



5.3 Patient Room, One Bed, Bariatric, Sideboard Toilet Option
(BRNP1) - 180 NSF [16.7 NSM]
Bathroom, Patient, Bariatric - (TLTS2) - 75 NSF [7.0 NSM]
Reflected Ceiling Plan



5.3 Patient Room, One Bed, Bariatric (BRNP1) - 180 NSF [16.7 NSM] Bathroom, Patient, Bariatric - (TLTS3) - 75 NSF [7.0 NSM]

Function:

This patient room is designed to accommodate obese patients (between 350-600 lbs in weight) and physically disabled patients who require greater maneuvering space and/or staff assistance for some basic life activities, such as dressing or hygiene. The room size and door widths are increased to allow appropriate maneuvering space and clearances for these patients. Fixtures, furnishings, grab bars and other features of the room should be designed for a weight capacity of 600 lbs minimum.

Portable patient lifts will be used for these patients as required. A permanent lift should not be installed in this room as they can be easily used as an anchor point. Any obese patient or mobility impaired patient who requires staff assistance to transfer from the patient bed either to a wheel chair or a standing position would be cared for in a medical wing where mental health services may be provided as required.

Note: Where VA standard items are shown, non-institutional & sustainable options should be considered if feasible.

Space Requirement:

Patient Room, One Bed, Bariatric: 180 NSF [16.7NSM]

Bathroom, Patient, Bariatric: 75 NSF [7.0 NSM]

Patient Room

Architectural:

Floor Finish:	Sheet vinyl, linoleum or rubber flooring
Base:	Rubber Base (Upgraded rubber base with molding profile recommended)
Wall Finish:	Impact Resistant Gypsum Board, painted finish
Ceiling:	Gypsum Board, painted finish
Ceiling Height:	10'-8" new construction, 9'-0" minimum
Noise (STC Rating):	40 STC
Hardware:	Refer to Sections 3 and 4 in the Guide.
Doors:	5'-0" x 7'-0" wood with view panel. 3'-6" x 1'-6" pair doors.
Windows:	Required by code, see PG-18-3, Topic 1, Codes and Standards. Window unit shall have integral blinds for sun control located between layers of glazing. Inside layer shall be laminated glass. If operable, window unit must not open more than 4 inches.

HVAC:

Inside Design Conditions:	70 degrees F (21C), 75 degrees F (24C) 30% - 50% Relative Humidity
Min. Supply Air Change/ Hr.:	6
Return Air:	Permitted
Exhaust Air:	Through connecting toilet
Room Noise Level:	NC 35
Individual Temperature Control:	Required
Room Air Balance:	Positive with respect to toilet, neutral with respect to corridor

Electrical:

Lighting Levels:	
Gen. Illumination:	30 fc (Fluorescent recessed cans with full plastic cover and secure fasteners)
Task Illumination:	75 fc at bed
Emerg. Illumination:	Provide one emergency light
Night Illumination:	Low level lighting for wayfinding to the bathroom. Ceiling mounted night light at entrance of patient bed room, controlled at exterior entrance
Emergency Power:	Provide one source
Telecommunications:	Yes
Medical Gases:	Not Applicable
Receptacles:	4 duplex per room and shall be tamper-resistant or equipped with ground-fault circuit interrupters (GFCI's)
Nurse Call:	Not required. If provided, cord length shall be 12" maximum

Bathroom

Architectural:

Floor Finish:	2 x2 ceramic tile. Shower pan may be ceramic tile or pre-manufactured solid surface basin.
Base:	Rubber Base
Wall Finish:	Epoxy Painted Gypsum Board. Solid Surface panels securely applied in shower areas
Ceiling:	Gypsum Board with Epoxy Paint
Ceiling Height:	10'-8" (New Construction) 9'-0" minimum
Noise (STC Rating):	40 STC
Slab Depression:	3" depression for sloping ceramic tile floor
Hardware:	Based on door option selected
Doors:	Wood door with sloped top set in 3'-6" x 7'-0" frame or other options - See Section 3.
Windows:	None

HVAC:

Inside Design Conditions:	Conditioned by make-up air
Min. Supply Air Changes/Hr.:	Not Applicable
Return Air:	Not Permitted
Exhaust Air:	Highest of 10 air changes per hour, 50 CFM or Room air balance.
Room Noise Level:	NC 35
Individual Room Temp. Control:	Not required
Room Air Balance:	Double negative

Electrical:

Lighting Levels:	
Gen. Illumination:	30 fc (Fluorescent recessed cans with full plastic cover and secure fasteners)
Task Illumination:	N/A
Night Illumination:	Low level lighting for wayfinding. Ceiling mounted night light at entrance of bathroom, controlled at exterior entrance
Emerg. Illumination:	Provide one source
Emergency Power:	Not Applicable
Receptacles:	1 GFCI
Nurse Call:	Not required, if provided, cord length should be 12" maximum.

5.3 Patient Room, One Bed, Bariatric (BRNP1) - 180 NSF [16.7 NSM] Bathroom, Patient, Bariatric - (TLTS3) - 75 NSF [7.0 NSM]

Equipment Table:

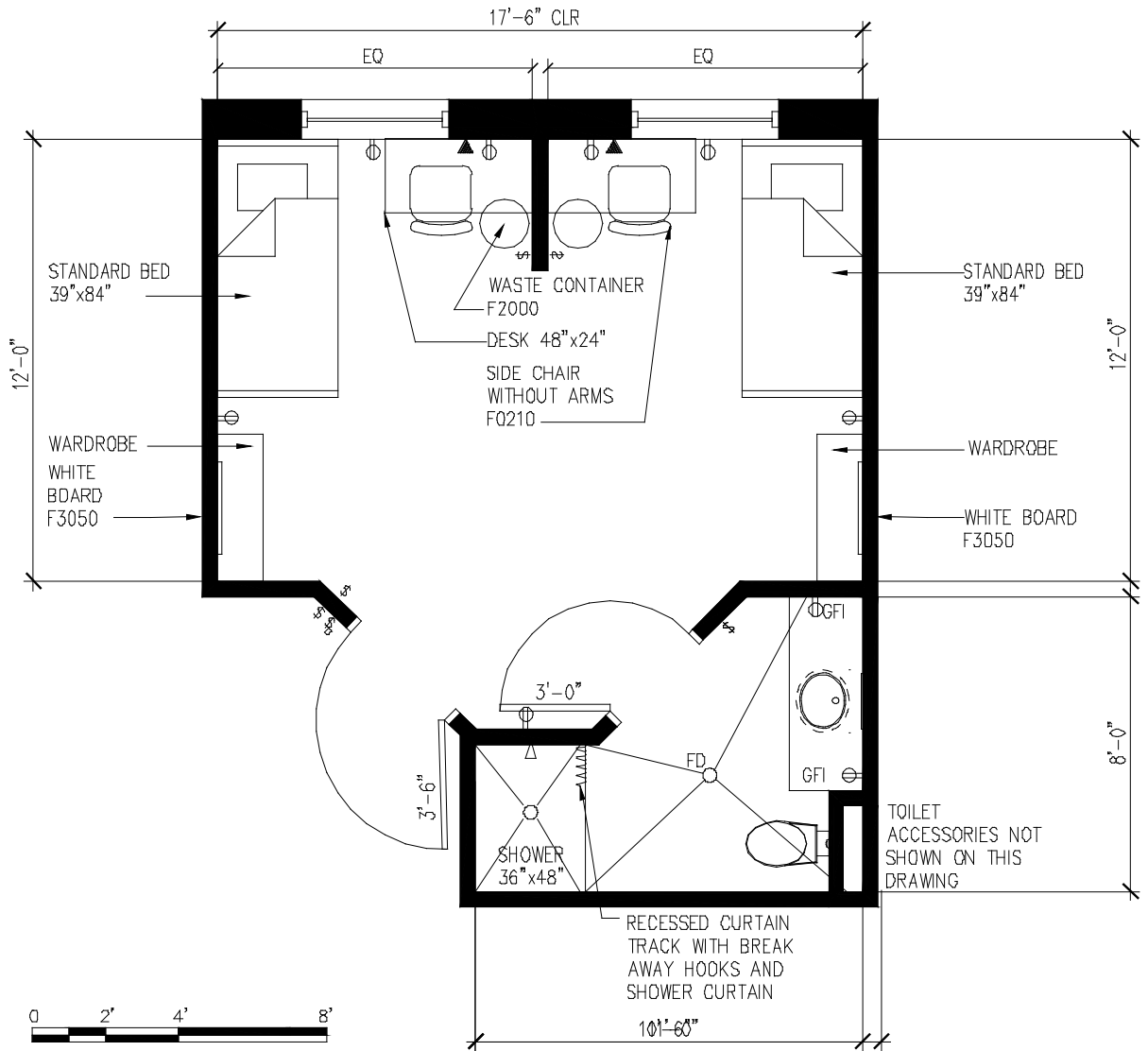
See Legend of Symbols in Section 1.6

JSN Number	QUANTITY	LC	DESCRIPTION
			Note: Where VA standard items are shown, non-institutional & sustainable options should be considered if feasible.
JSN U7011	1	VV	BED, PLATFORM WITH MATTRESS 1066mm x 2386mm x 457mm (42" w x 94" h x 18" d)
JSN U0210	1	W	CHAIR, BARIATRIC, SIDE, NON-TILTING, NO ARMS, UPHOLSTERED 812mm x 660mm x 584mm (32" h x 26" w x 23" d)
NO JSN	1	CC	BUILT IN PATIENT DESK, SOLID SURFACE COUNTER 1066mm x 609mm x 761mm (42" w x 24" d x 30" h)
NO JSN	1	VV	OPEN SHELVING FOR PATIENT CLOTHING- SOLID SURFACE TOP 1218mm x 457mm x 761mm (48" w x 18" d x 30" h)
JSN F2000	1	VV	WASTE CONTAINER – PLASTIC 457mm x 406mm dia. (18" h x 16" dia.)
JSN F3050	1	CC	WHITE PORCELAIN MAKER BOARD, WALL MOUNTED WITH SECURE FASTENERS
			BATHROOM, BARIATRIC PATIENT (TLTS3):
JSN P9400	1	CC	TOILET, FLOOR MOUNTED 600 LB WEIGHT LIMIT SIPHON JET WATER CLOSET/ TOILET., BACK SPUD PUSH BUTTON FLUSH VALVE, SEAT WITH OPEN FRONT AND CHECK HINGE, AND CARRIER
JSN A5109	AR	CC	GRAB BAR 1-1/4" DIA., STAINLESS STEEL, WITH PLATE BETWEEN WALL AND BAR FOR WATER CLOSET
JSN A5200	1	CC	SAFETY TOILET TISSUE DISPENSER WITH SOFT SPINDLE
NO JSN	1	CC	VANITY, SOLID SURFACE COUNTER TOP, MOLDED SELF EDGE AND BACKSPLASH; INTEGRAL LAVATORY L
JSN A5075	1	VV	DISPENSER, SOAP, DISPOSABLE
JSN A1066	1	CC	MIRROR, STAINLESS STEEL FRAME WITH PLEXIGLASS, 457mm x 914mm (18" w x 36" h)
JSN U5080	1	CC	PAPER TOWEL DISPENSER, SATIN FINISH STAINLESS STEEL, SINGLE-FOLD, RECESSED
	1	CC	PSYCHIATRIC PATIENT SHOWER CONTROLS
	1	CC	SHOWER: SOAP DISH, RECESSED
JSN A5110	AR	CC	GRAB BAR 1-1/4" DIA., STAINLESS STEEL, WITH PLATE BETWEEN WALL AND BAR FOR SHOWER
JSN U5145	3	CC	HOOKS, COLLAPSIBLE STAINLESS STEEL

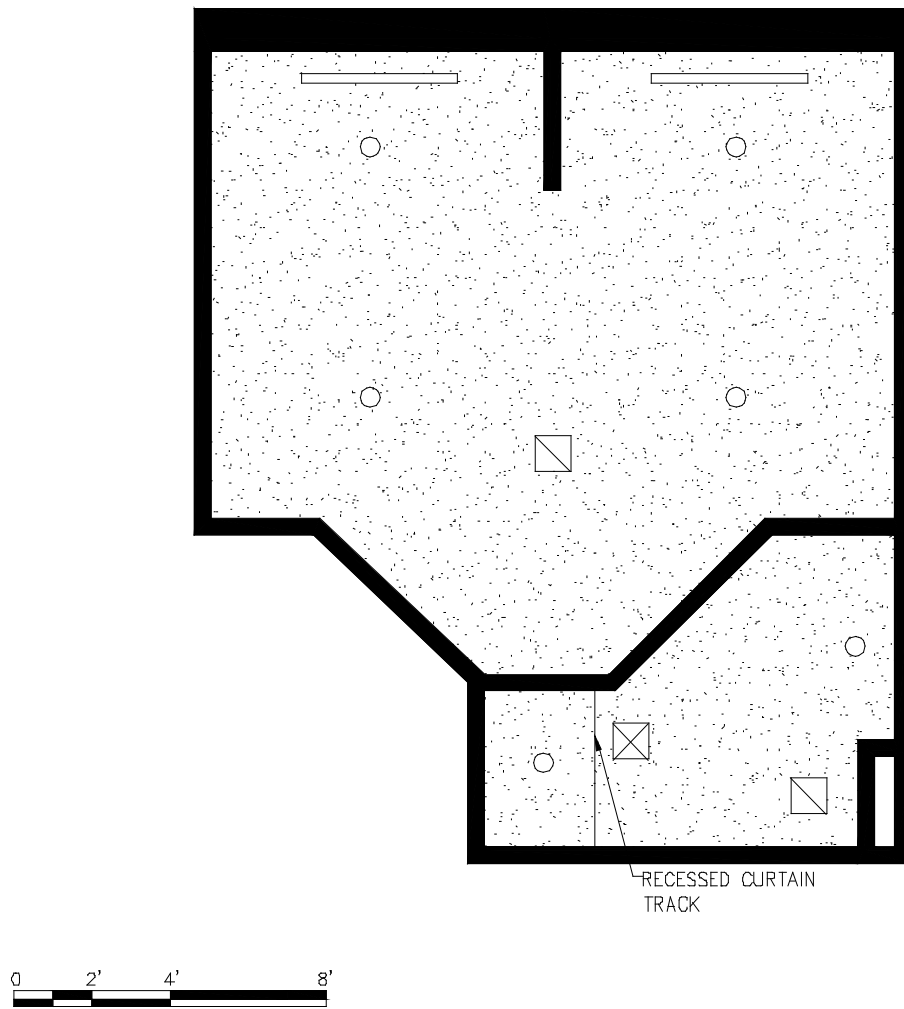
JSN Number	QUANTITY	LC	DESCRIPTION
	1	CC	CURTAIN TRACK, RECESSED
	1	CC	CURTAIN – SHOWER WITH COLLAPSIBLE HOOKS
JSN F2000	1	VV	WASTE CONTAINER , PLASTIC 457mm x 406mm (18" high X 16" dia.)

TABLE 5.3
Patient Room, Bariatric / Bathroom, Bariatric Patient

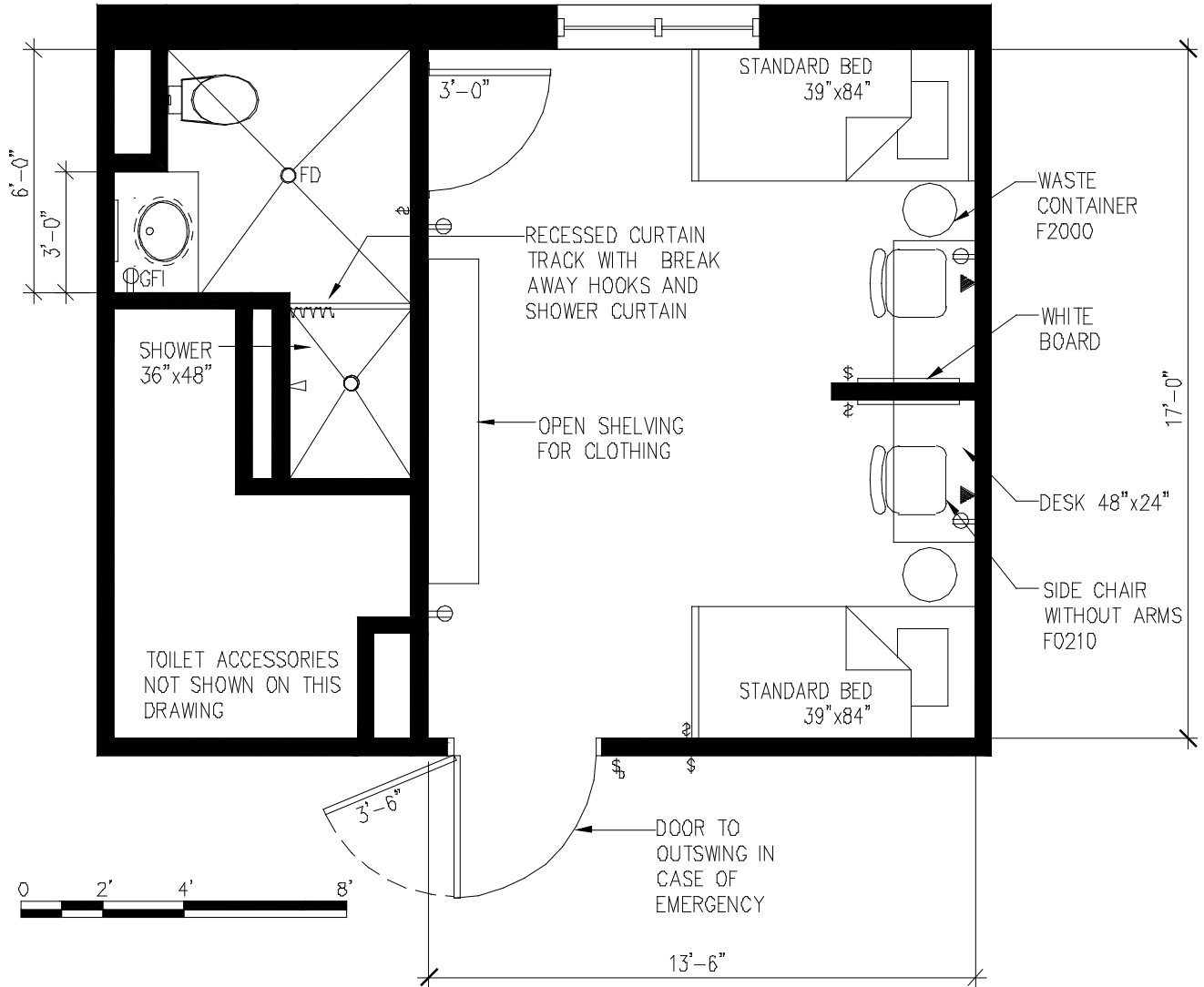
5.4 Patient Room, Two Bed, Inboard Toilet Option (BRNP2)
 230 NSF - [21.4 NSM]
 Bathroom, Patient, Standard (TLTS2) - 60 NSF [5.6 NSM]
 Floor Plan



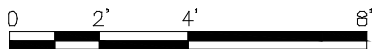
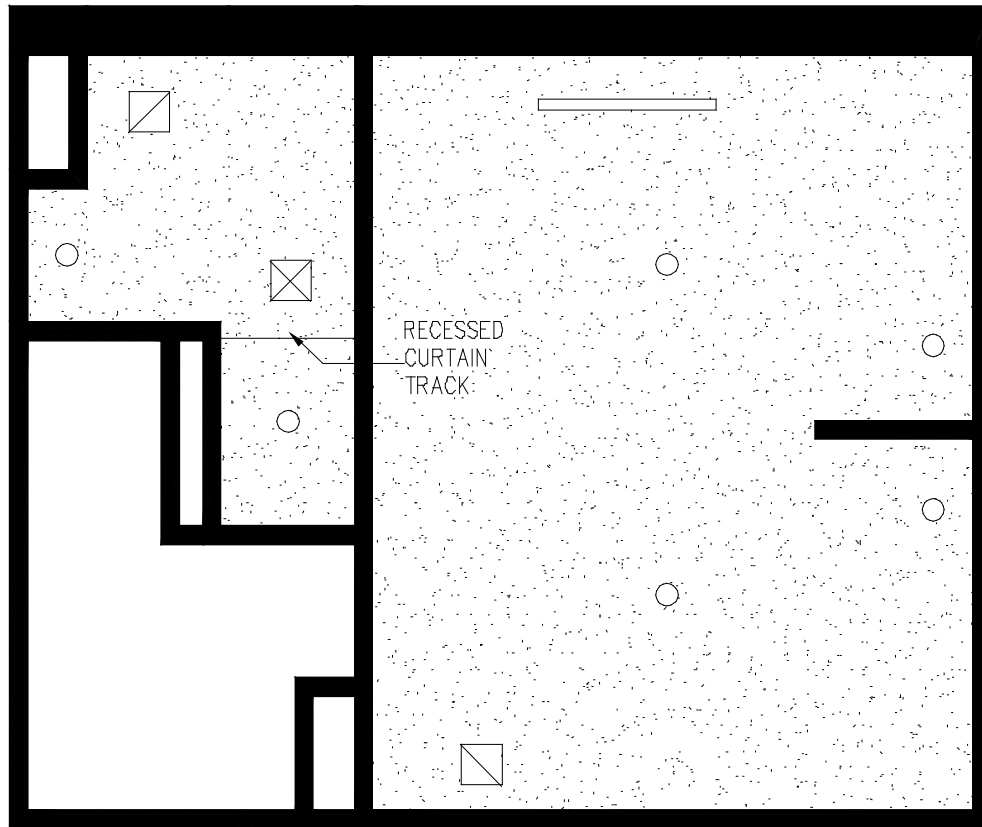
5.4 Patient Room, Two Bed, Inboard Toilet Option (BRNP2)
230 NSF - [21.4 NSM]
Bathroom, Patient, Standard (TLTS2) - 60 NSF [5.6 NSM]
Reflected Ceiling Plan



5.4 Patient Room, Two Bed, Sideboard Toilet Option (BRNP2)
 230 NSF - [21.4 NSM]
 Bathroom, Patient, Standard (TLTS2) - 60 NSF [5.6 NSM]
 Floor Plan



5.4 Patient Room, Two Bed, Sideboard Toilet Option (BRNP2)
230 NSF - [21.4 NSM]
Bathroom, Patient, Standard (TLTS2) - 60 NSF [5.6 NSM]
Reflected Ceiling Plan



5.4 Patient Room, Two Bed (BRNP2) - 230 NSF [21.4 NSM] Bathroom, Patient, Standard (TLTS3) - 60 NSF [5.6 NSM]

Function:

Double occupancy inpatient rooms comprise 50% of the bed space in a typical inpatient unit. These rooms are designed to accommodate the full range of in-patient classifications. The square footage of the adjacent toilet/shower room shown in this plan is not included in the total.

Note: Where VA standard items are shown, non-institutional & sustainable options should be considered if feasible.

Space Requirement:

Patient Room: 230 NSF [21.4 NSM]

Toilet Room: 60 NSF [5.7 NSM]

Patient Room

Architectural:

Floor Finish:	Sheet vinyl, linoleum or rubber flooring
Base:	Rubber Base (Upgraded rubber base with molding profile recommended)
Wall Finish:	Impact Resistant Gypsum Board, painted finish
Ceiling:	Gypsum Board, painted finish
Ceiling Height:	10'-8" new construction, 9'-0" minimum
Noise (STC Rating):	40 STC
Hardware:	Refer to Sections 3 and 4 in the Guide.
Doors:	3'-6" x 7'-0" wood with view panel.
Windows:	Required by code, see PG-18-3, Topic 1, Codes and Standards. Window unit shall have integral blinds for sun control located between layers of glazing. Inside layer shall be laminated glass. If operable, window unit must not open more than 4 inches.

HVAC:

Inside Design Conditions:	70 degrees F (21C), 75 degrees F (24C) 30% - 50% Relative Humidity
Min. Supply Air Change/ Hr.:	6
Return Air:	Permitted
Exhaust Air:	Through connecting toilet
Room Noise Level:	NC 35
Individual Temperature Control:	Required
Room Air Balance:	Positive with respect to toilet, neutral with respect to corridor

Electrical:

Lighting Levels:	
Gen. Illumination:	30 fc (Fluorescent recessed cans with full plastic cover and secure fasteners)
Task Illumination:	75 fc at bed
Emerg. Illumination:	Provide one emergency light
Night Illumination:	Low level lighting for wayfinding to the bathroom. Ceiling mounted night light at entrance of patient bed room, controlled at exterior entrance
Emergency Power:	Provide one source
Telecommunications:	Yes
Medical Gases:	Not Applicable

Receptacles: 4 duplex per room and shall be tamper-resistant or equipped with ground-fault circuit interrupters (GFCI's)
 Nurse Call: Not required. If provided, cord length shall be 12" maximum

Bathroom

Architectural:

Floor Finish: 2" x 2" ceramic tile. Shower pan may be ceramic tile or pre-manufactured solid surface basin.
 Base: Rubber Base
 Wall Finish: Epoxy Painted Gypsum Board. Solid Surface panels securely applied in shower areas
 Ceiling: Gypsum Board with Epoxy Paint
 Ceiling Height: 10'-8" (New Construction) 9'-0" minimum
 Noise (STC Rating): 40 STC
 Slab Depression: 3" depression for sloping ceramic tile floor
 Hardware: Based on door option selected
 Doors: Wood door with sloped top set in 3'-0" x 7'-0" frame or other options - See Section 3.
 Windows: None

HVAC:

Inside Design Conditions: Conditioned by make-up air
 Min. Supply Air Changes/Hr.: Not Applicable
 Return Air: Not Permitted
 Exhaust Air: Highest of 10 air changes per hour, 50 CFM or Room air balance.
 Room Noise Level: NC 35
 Individual Room Temp. Control: Not required
 Room Air Balance: Double negative

Electrical:

Lighting Levels:
 Gen. Illumination: 30 fc (Fluorescent recessed cans with full plastic cover and secure fasteners)
 Task Illumination: N/A
 Night Illumination: Low level lighting for wayfinding. Ceiling mounted night light at entrance of bathroom, controlled at exterior entrance
 Emerg. Illumination: Provide one source
 Emergency Power: Not Applicable
 Receptacles: 1 GFCI
 Nurse Call: Not required, if provided, cord length should be 12" maximum.

5.4 Patient Room, Two Bed (BRNP2) - 230 NSF [21.4 NSM] Bathroom, Patient, Standard (TLTS3) - 60 NSF [5.6 NSM]

Equipment Table:

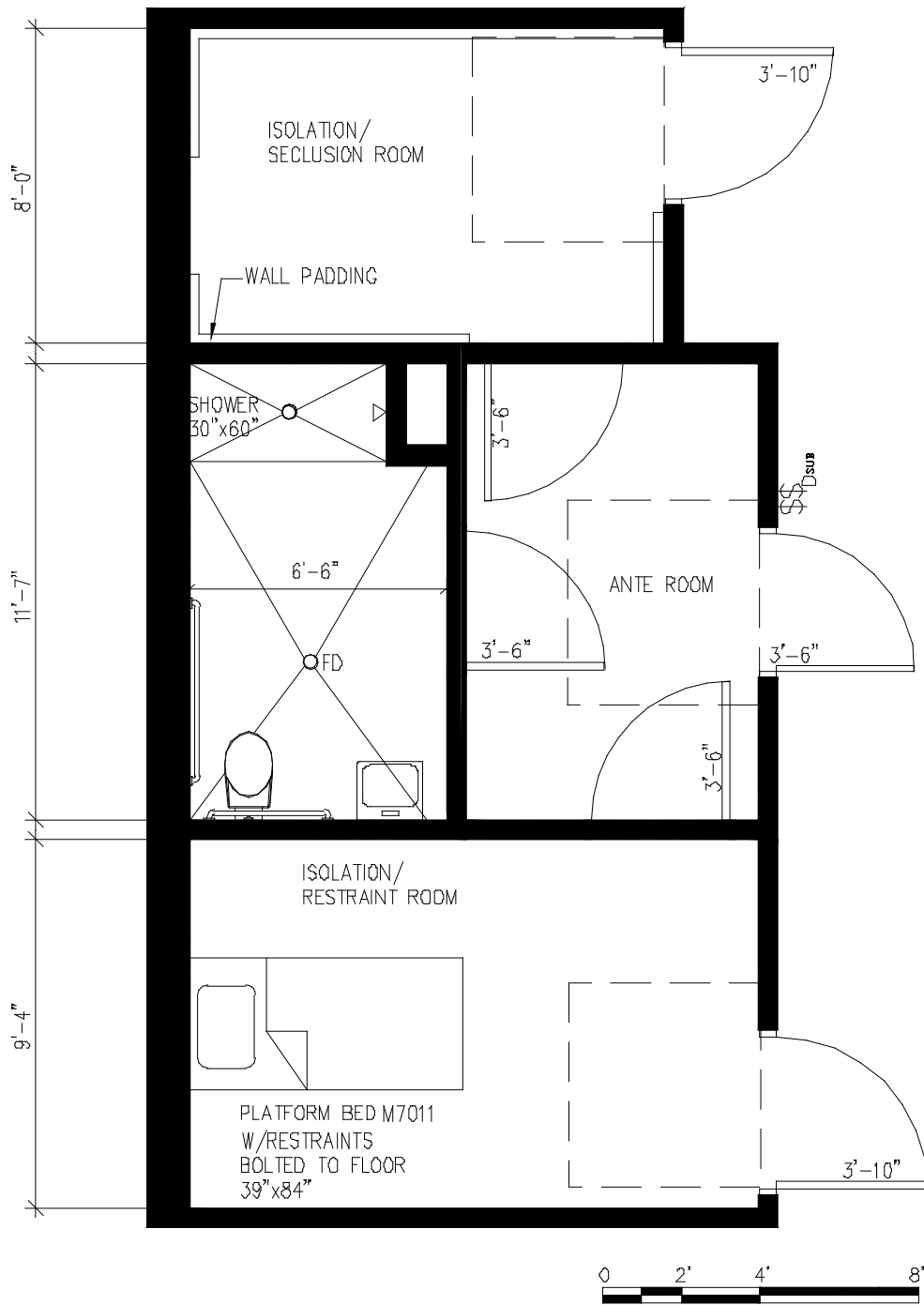
See Legend of Symbols in Section 1.6

SYMBOL	QUANTITY	AI	DESCRIPTION
			Note: Where VA standard items are shown, non-institutional & sustainable options should be considered if feasible.
JSN M7011	2	VV	BED, PLATFORM WITH MATTRESS, 1067 mm X 2388 mm (40"w x 83"l x 18"h)
JSN F0210	2	W	CHAIR, SIDE- NON-TILTING, NO ARMS, UPHOLSTERED 812mm x 482mm x 584mm (32"h x 19"w x 23"d)
NO JSN	2	CC	BUILT IN PATIENT DESK, SOLID SURFACE COUNTER, 913mm x 609mm x 761mm (36"w x 24" d x 30"h)
NO JSN	2		OPEN SHELVING FOR PATIENT CLOTHING- SOLID SURFACE COUNTER TOP 1218mm x 457mm x 761mm (48" x 18"d x 30"h)
JSN F2000	2	VV	WASTE CONTAINER - PLASTIC 457mm x 406mm dia. (18"h x 16" dia.)
JSN F3050	1	CC	WHITE BOARD MOUNTED TO WALL WITH SECURE FASTENERS
			BATHROOM (TLTS3):
JSN P9400	1	CC	TOILET, BACK SPUD PUSH BUTTON FLUSH VALVE, SEAT WITH OPEN FRONT AND CHECK HINGE
JSN A5200	1	CC	SAFETY TOILET TISSUE DISPENSER WITH SOFT SPINDLE
NO JSN	1	CC	VANITY, WITH SOLID SURFACE COUNTER TOP, MOLDED SELF EDGE AND BACKSPLASH; INTEGRAL LAVATORY
JSN A5075	1	VV	DISPENSER, SOAP, DISPOSABLE
JSN A1066	1	CC	MIRROR, STAINLESS STEEL FRAME WITH PLEXIGLASS 457mm x 914mm (18"w x 36"h)
JSN U5080	1	VV	PAPER TOWEL DISPENSER, SATIN FINISH STAINLESS STEEL, SINGLE-FOLD, RECESSED
JSN U5145	6	CC	TOWEL HOOKS, COLLAPSIBLE STAINLESS STEEL
	1	CC	PSYCHIATRIC PATIENT SHOWER CONTROLS
	1	CC	SHOWER: SOAP DISH, RECESSED
	1	CC	CURTAIN TRACK, RECESSED
	1	CC	CURTAIN – SHOWER(BREATHABLE) WITH COLLAPSIBLE HOOKS
JSN F2000	1	VV	WASTE CONTAINER, PLASTIC 457mm x 406mm dia. (18"h x 16" dia.)

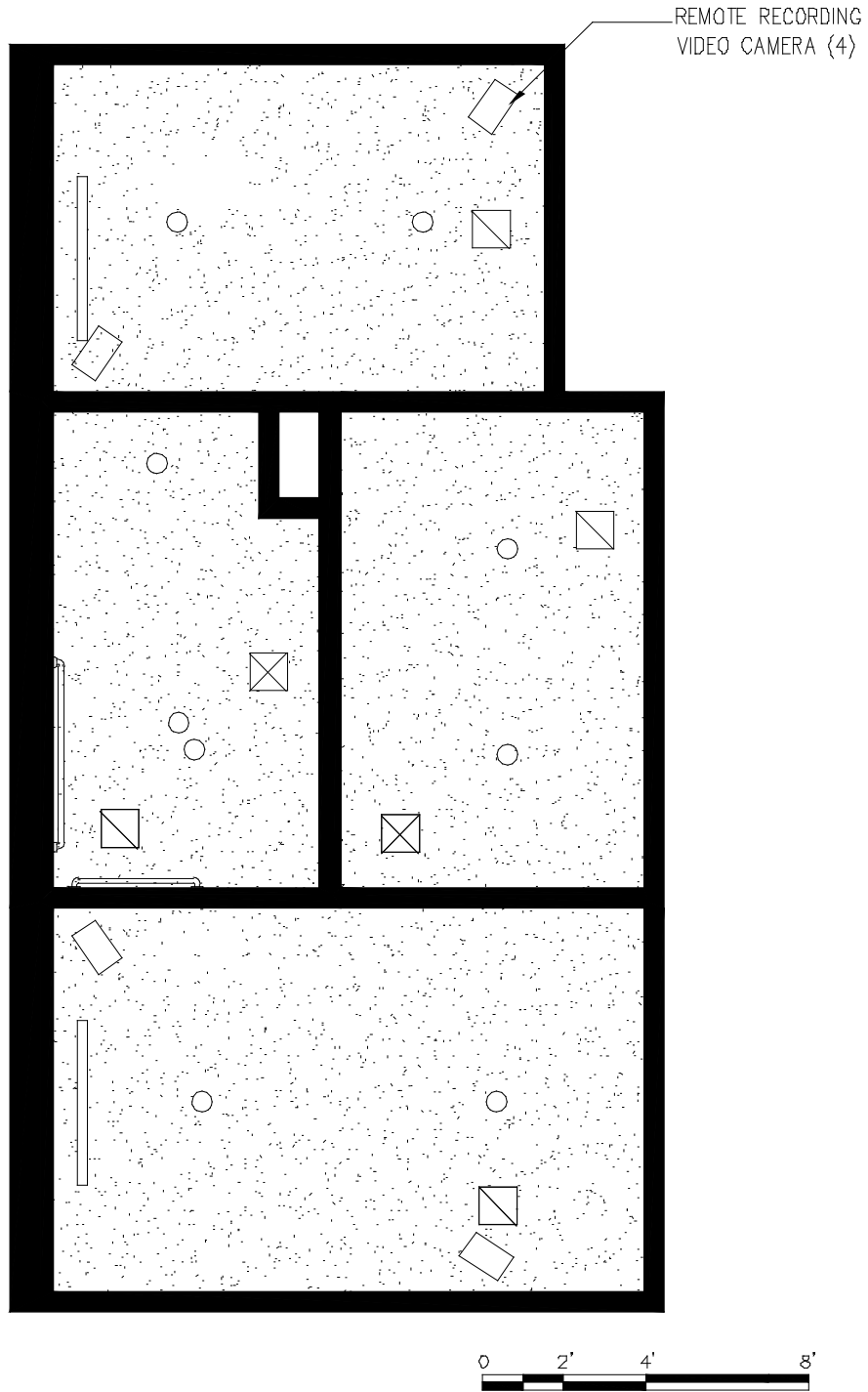
TABLE 5.4

Patient Room, Two Bed/ Bathroom, Patient, Standard

5.5 Isolation, Restraint (BRNP5) - 125 NSF [11.6 NSM]
Isolation, Seclusion - 80 NSF [7.4 NSM]
Anteroom - (BRNP6) - 80 NSF [7.4 NSM]
Bathroom, Patient, Standard (TLTS3) - 65 NSF [6.0 NSM]
Floor Plan



- 5.5 Isolation, Restraint (BRNP5) - 125 NSF [11.6 NSM]
- Isolation, Seclusion - 80 NSF [7.4 NSM]
- Anteroom - (BRNP6) - 80 NSF [7.4 NSM]
- Bathroom, Patient, Standard (TLTS3) - 65 NSF [6.0 NSM]
- Reflected Ceiling Plan



**5.5 Isolation, Restraint (BRNP5) - 125 NSF [11.6 NSM]
 Isolation, Seclusion - 80 NSF [7.4 NSM]
 Anteroom - (BRNP6) - 80 NSF [7.4 NSM]
 Bathroom, Patient, Standard (TLTS3) - 65 NSF [6.0 NSM]**

Function:

The isolation suite may consist of one restraint room, one seclusion room, an anteroom and a bathroom accessed directly off the anteroom. This suite should be easily accessed from the nursing station but should not be located in view of other patients in the unit. When patients are housed in either of these rooms, a staff member will be viewing the patient directly from the anteroom. Restraint rooms have a bed or platform that allows a patient to be temporarily restrained. There should be sufficient space in this room to allow staff to access the patient on at least three sides. Seclusion rooms have no furniture and are padded to prevent patient self harm. Isolation rooms are less frequently used in VA Mental Health facilities.

Note: Where VA standard items are shown, non-institutional & sustainable options should be considered if feasible.

Space Requirements:

Isolation, Restraint:	125 NSF [11.6 NSM]
Anteroom:	80 NSF [7.4 NSM]
Bathroom:	65 NSF [6.0 NSM]
Isolation, Seclusion:	80 NSF [7.4 NSM]

Isolation, Restraint/Isolation, Seclusion/Ante Room

Architectural:

Floor Finish:	Sheet vinyl, linoleum or rubber flooring
Base:	Rubber Base (Upgraded rubber base with molding profile recommended)
Wall Finish:	Impact Resistant Gypsum Board, painted finish
Ceiling:	Gypsum Board, painted finish
Ceiling Height:	10'-8" new construction, 9'-0" minimum
Noise (STC Rating):	45 STC.
Special Construction:	One-way mirror laminate glazing between ante-room and isolation or seclusion rooms. Security grade hollow metal and glass stops on ante-room side.
Hardware:	VA #9 (Isolation/seclusion room doors), VA #54 (anteroom entry door)
Doors:	Seclusion Room from corridor 3'-10" x 7'-0" Seclusion Room from anteroom 3'-6" x 7'-0" Wood or metal, with security grade hollow metal frames. Provide laminate glass observation window in the door only large enough to see into the room adequately
Exterior Windows:	Seclusion Room to Ante room 3'-6" x 7'-0" wood or metal. An exterior window, if utilized, should be small and fixed with glazing meeting VA impact resistance requirements. Blinds should be located between the interior and exterior glazing with no exposed hardware in the room. Set the sill high enough to prevent kicking.

HVAC:

Inside Design Conditions:	70 degrees F (21C), 75 degrees F (24C) 30% - 50% Relative Humidity
---------------------------	---

Min. Supply Air Change/ Hr.:	6
Return Air:	Permitted
Room Noise Level:	NC 35
Individual Temperature Control:	Required
Room Air Balance:	Neutral with respect to corridor and anteroom.

Electrical:

Lighting Levels:	
Gen. Illumination:	30 fc (Fluorescent recessed cans with full plastic cover and secure fasteners)
Task Illumination:	75 fc at bed
Emerg. Illumination:	Provide one emergency light
Night Illumination:	Low level lighting for wayfinding to the bathroom. Ceiling mounted night light at entrance of patient bed room, controlled at exterior entrance
Emergency Power:	Provide one source
Telecommunications:	Yes
Medical Gases:	Not Applicable
Receptacles:	4 duplex per room and shall be tamper-resistant or equipped with ground-fault circuit interrupters (GFCI's)
Nurse Call:	Not required. If provided, cord length shall be 12" maximum

Bathroom, Seclusion Room**Architectural:**

Floor Finish:	2" x 2" ceramic tile. Shower pan may be ceramic tile or pre-manufactured solid surface basin.
Base:	Rubber Base
Wall Finish:	Epoxy Painted Gypsum Board. Solid Surface panels securely applied in shower areas
Ceiling:	Gypsum Board with Epoxy Paint
Ceiling Height:	10'-8" (New Construction) 9'-0" minimum
Noise (STC Rating):	40 STC
Slab Depression:	3" depression for sloping ceramic tile floor
Hardware:	VA Hardware Set 14
Doors:	3'-0" x 7'-0" Wood or metal door frame or other options
Windows:	None

HVAC:

Inside Design Conditions:	Conditioned by make-up air (interior). Heat to 68 degrees minimum if bathroom is on the building perimeter.
Min. Supply Air Changes/Hr.:	Not Applicable
Return Air:	Not Permitted
Exhaust Air:	Highest of 10 air changes per hour, 50 CFM or Room air balance.
Room Noise Level:	NC 35
Individual Room Temp. Control:	Required only if heated
Room Air Balance:	Double negative

Electrical:

Lighting Levels:	
Gen. Illumination:	30 fc (Fluorescent recessed cans with full plastic cover and secure fasteners)
Task Illumination:	Not Applicable
Night Illumination:	Not Applicable
Emerg. Illumination:	Provide one source

Emergency Power:	Not Applicable
Receptacles:	1 GFCI
Nurse Call:	Not required.

- 5.5 Isolation, Restraint (BRNP5) - 125 NSF [11.6 NSM]
 Isolation, Seclusion - 80 NSF [7.4 NSM]
 Anteroom - (BRNP6) - 80 NSF [7.4 NSM]
 Bathroom, Patient, Standard (TLTS3) - 65 NSF [6.0 NSM]

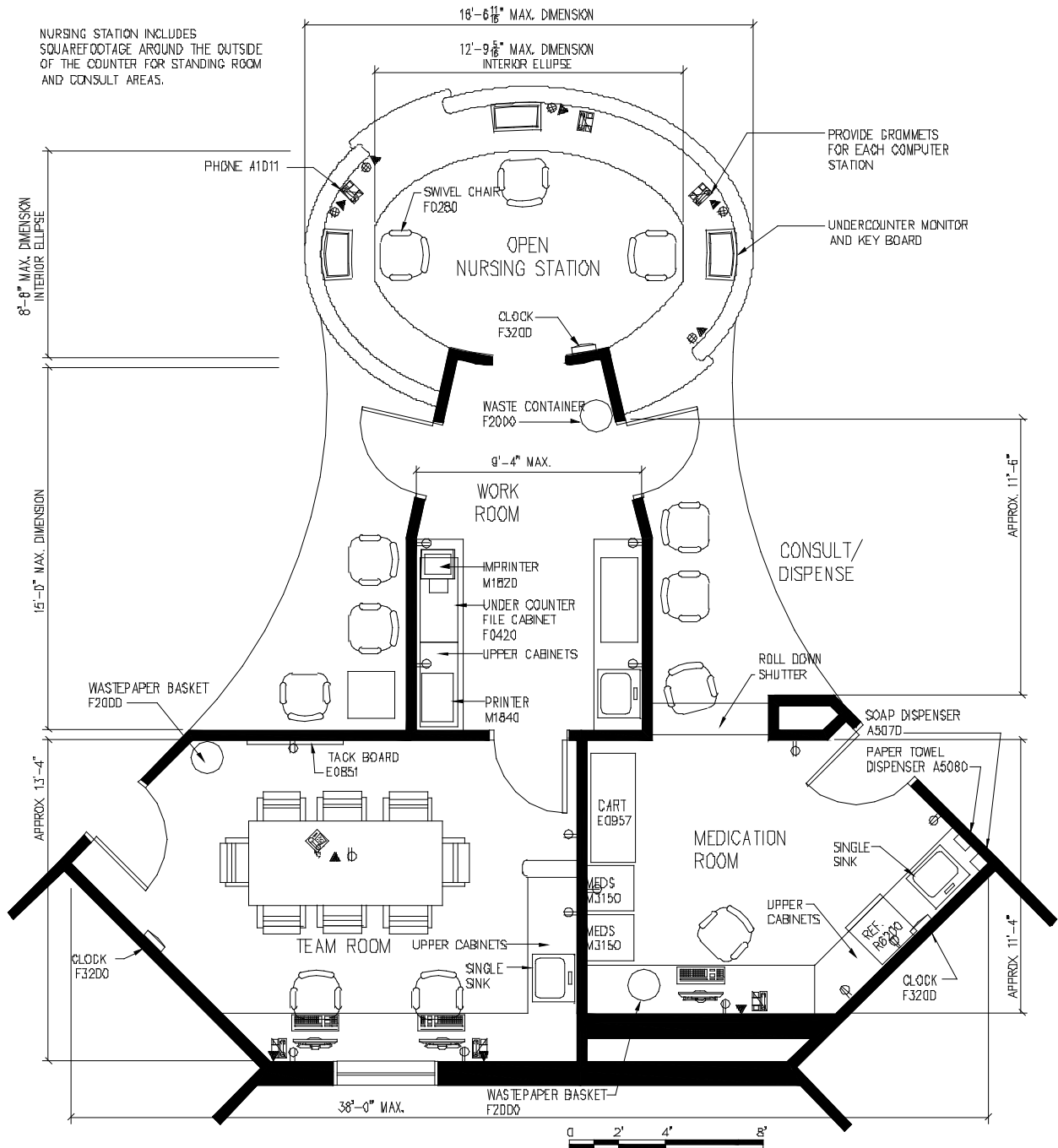
Equipment Table:

See Legend of Symbols in Section 1.6

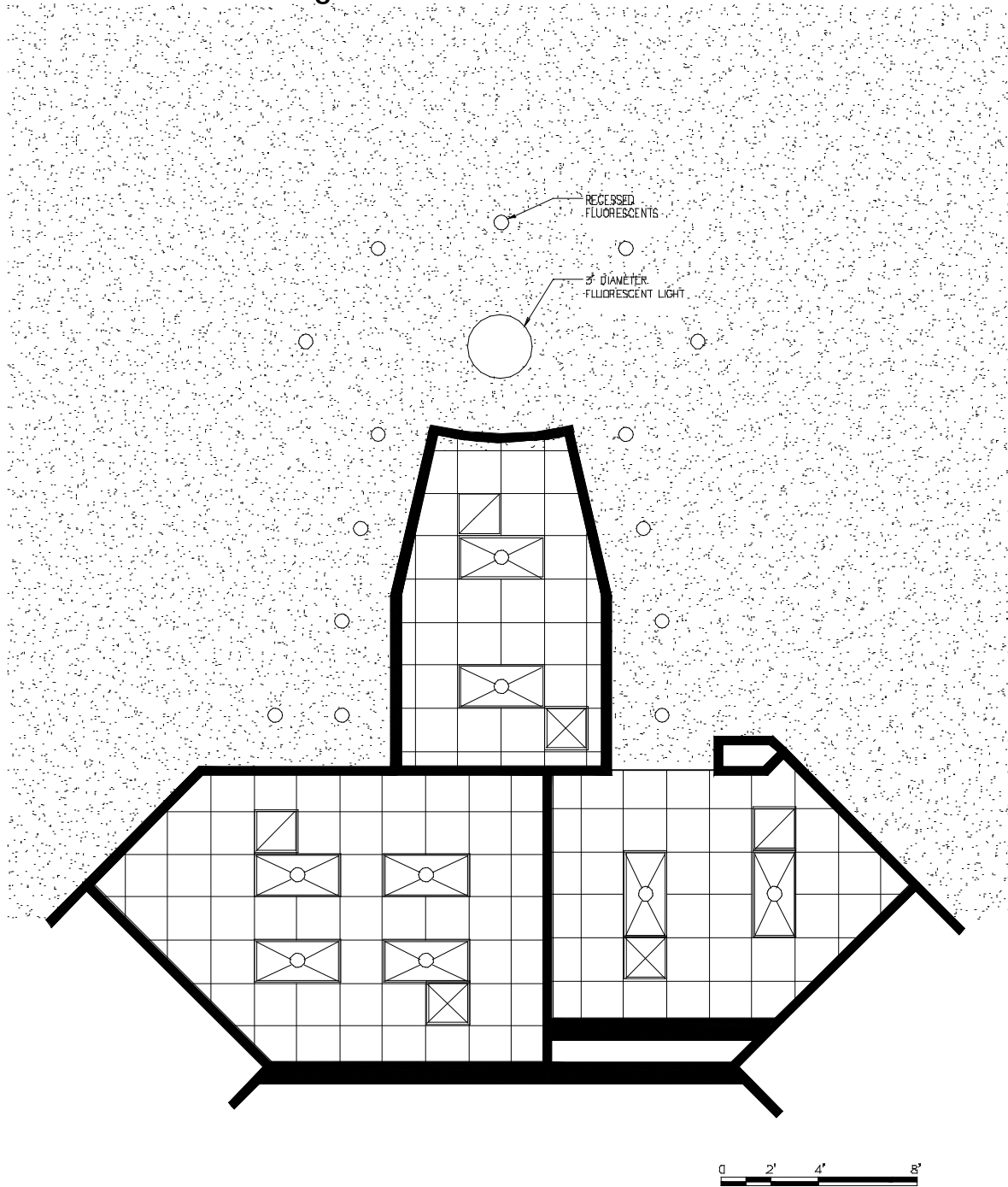
SYMBOL	QUANTITY	AI	DESCRIPTION
			Note: Where VA standard items are shown, non-institutional & sustainable options should be considered if feasible.
ISOLATION, RESTRAINT (BRNP5)			
	2	CC	VIDEO RECORDER WITH REMOTE CAPABILITY
JSN M7011	1	VV	PLATFORM BED AND MATTRESS, EIGHT RESTRAINT HOLDERS, TWO AT HEAD AND FOOT, THREE AT EACH SIDE, CONCEALED STEEL FRAME, AND MEANS TO BOLT TO THE FLOOR. 1015mm x 2106mm x 457mm (40"w x 83"l x 18"h).
BATHROOM (TLTP3)			
JSN P9400	1	CC	TOILET, WALL HUNG, SIPHON JET, BACK SPUD PUSH BUTTON FLUSH VALVE, SEAT WITH OPEN FRONT AND CHECK HINGE,
JSN A5109	AR	CC	GRAB BAR 1-1/4" DIA., STAINLESS STEEL, 2 WALL, WITH PLATE BETWEEN WALL AND BAR FOR WATER CLOSET
NO JSN	1	CC	SAFETY TOILET TISSUE DISPENSER WITH SOFT SPINDLE
JSN P9160	1	CC	LAVATORY, WALL MOUNTED. UNIT SHALL BE CONSTRUCTED OF VITREOUS CHINA WITH INTEGRAL FAUCET AND SOAP DISH. SHALL HAVE SELF-CLOSING PUSHBUTTON VALVES.
JSN A5075	1	VV	DISPENSER, SOAP, DISPOSABLE
JSN A1085	1	CC	MIRROR, STAINLESS STEEL, WITH STAINLESS STEEL FRAME, 457mm x 914mm (36"h x 18"w)
JSN U5080	1	VV	PAPER TOWEL DISPENSER, SATIN FINISH STAINLESS STEEL, SINGLE-FOLD, RECESSED
JSN P5350	1	CC	PSYCHIATRIC PATIENT SHOWER HEAD & CONTROLS.
JSN A5110	AR	CC	GRAB BAR 1-1/4" DIA., STAINLESS STEEL, 2 WALL, WITH PLATE BETWEEN WALL AND BAR FOR SHOWER

TABLE 5.5
Isolation Suite

5.6 Nursing Station (NSTA1) - 300 NSF [27.9 NSM]
 Nurse Workroom (WRCH1) - 120 NSF [11.2 NSM]
 Medication Room (MEDP1) - 120 NSF [11.2 NSM]
 Team Room (CRA01) - 220 NSF [20.4 NSM]
 Floor Plan



- 5.6 Nursing Station (NSTA1) - 300 NSF [27.9 NSM]
 - Nurse Workroom (WRCH1) - 120 NSF [11.2 NSM]
 - Medication Room (MEDP1) - 120 NSF [11.2 NSM]
 - Team Room (CRA01) - 220 NSF [20.4 NSM]
- Reflected Ceiling Plan



**5.6 Nursing Station (NSTA1) - 300 NSF [27.9 NSM]
 Nurse Workroom (WRCH1) - 120 NSF [11.2 NSM]
 Medication Room (MEDP1) - 120 NSF [11.2 NSM]
 Team Room (CRA01) – 220 NSF [20.4 NSM]**

Function:

These spaces form the central control point for the patient unit.

Nursing Station: The nursing station should be open and positioned to allow for direct visibility to all patient housing wings, dayroom, dining, outdoor courtyard and patient unit entry. The nursing station should also have direct access to a locked workroom. The team conference room and medication room should be immediately adjacent. The open nursing station will act as a home base for staff who will be frequently roaming the unit.

Nurse Workroom: The work room should be located directly behind the nursing station to accommodate office equipment such as printers, patient charts and so forth.

Medication Room: This room should be secured and should be directly adjacent to the open nursing station. Medications may be dispensed to patients directly from this room so a pass through provision should be provided for this purpose.

Team Room: This space should be located directly behind the nursing station. This room allows for private conversations between care team professionals, to be used as a quick break area by nursing staff and to allow quick chart review/patient records access by care team professionals not based at the nursing station. This area is not intended to be a space to meet with patients, visitors or patient family members.

Note: Where VA standard items are shown, non-institutional & sustainable options should be considered if feasible.

Space Requirement:

Nursing Station: 300 NSF [27.9 NSM]
 Nurse Workroom: 120 NSF [11.2 NSM]
 Medication Room: 120 NSF [11.2 NSM]
 Team Room: 220 NSF [29.0 NSM]

Nursing Station

Architectural:

Floor Finish:	Sheet vinyl, linoleum or rubber flooring to match adjacent corridor floor finish
Base:	Rubber Base
Wall Finish:	Gypsum Board
Ceiling:	Acoustical Ceiling with Gypsum Board soffits
Ceiling Height:	10'-8" preferred, 9'-0" minimum
Noise (STC Rating):	N/A.
Slab Depression:	None
Special Construction:	Laminated glass inserted into nursing station for security, if required.
Hardware:	None
Doors:	3'-0" with vision panel.
Windows:	Optional based on individual design

HVAC:

Inside Design Conditions: 70 degrees F (21C), 75 degrees F (24C)
 30%- 50% Relative Humidity
 Min. Supply Air Change/ Hr.: 4 .
 Return Air: Permitted
 Room Noise Level: NC 40
 Individual Temperature Control: Required
 Room Air Balance: As appropriate to adjoining spaces.

Electrical:

Lighting Levels:
 Gen. Illumination: 30 fc Recessed fluorescent fixtures with solid lens recommended.
 Task Illumination: 50 fc
 Emerg. Illumination: Provide one source
 Telecommunications: Provide on phone/data outlet at each workstation station and as required for additional equipment in this area
 Emergency Power: Provide one source
 Receptacles: As required

Work Room**Architectural:**

Floor Finish: Sheet vinyl, linoleum or rubber flooring.
 Base: Rubber Base
 Wall Finish: Gypsum Board painted finish
 Ceiling: Acoustical Tile
 Ceiling Height: 9'-0" minimum above floor.
 Noise (STC Rating): Not Applicable.
 Hardware: VA Hardware Set # 13
 Doors: 3'-0" x 7'-0" Wood with ½ lite-laminated glass.
 Windows: Interior glazing shall be laminated glass.

HVAC:

Inside Design Conditions: 70 degrees F (21C), 75 degrees F (24C)
 30%- 50% Relative Humidity
 Min. Supply Air Change/ Hr.: 4 .
 Return Air: Permitted if exhaust not required
 Exhaust Air: As required based on equipment in this space
 Room Noise Level: NC 40
 Individual Temperature Control: Based on design
 Room Air Balance: Neutral.

Electrical:

Lighting Levels:
 Gen. Illumination: 30 fc Recessed fluorescent fixtures with solid lens recommended.
 Task Illumination: 75 fc
 Emerg. Illumination: As required
 Telecommunications: 1
 Emergency Power: Provide one source
 Receptacles: As required

Medication Room**Architectural:**

Floor Finish:	Sheet vinyl, linoleum or rubber flooring.
Base:	Rubber Base
Wall Finish:	Gypsum Board painted finish
Ceiling:	Acoustical Tile
Ceiling Height:	9'-0" minimum above floor.
Noise (STC Rating):	Not Applicable.
Hardware:	VA Hardware Set # 13
Doors:	3'-0" x 7'-0" Wood with ½ lite-laminated glass.
Windows:	Interior glazing shall be laminated glass.

HVAC:

Inside Design Conditions:	70 degrees F (21C), 75 degrees F (24C) 30%- 50% Relative Humidity
Min. Supply Air Change/ Hr.:	6 .
Return Air:	Permitted if exhaust not required
Exhaust Air:	As required based on equipment in this space
Room Noise Level:	NC 35
Individual Temperature Control:	Based on design
Room Air Balance:	Neutral.

Electrical:

Lighting Levels:	
Gen. Illumination:	50 fc. Recessed fluorescent fixtures with solid lens recommended.
Task Illumination:	75 fc
Emerg. Illumination:	As required
Telecommunications:	1
Emergency Power:	Provide for refrigerator and computer
Receptacles:	As required

Team Room**Architectural:**

Floor Finish:	Carpet, Carpet Tile or resilient flooring
Base:	Rubber Base
Wall Finish:	Gypsum Board
Ceiling:	Acoustic Tile
Ceiling Height:	9'-0" minimum
Noise (STC Rating):	40 STC.
Hardware:	VA Hardware Set # 13
Doors:	3'-0" x 7'-0" wood with ½ lite- glass clad polycarbonate.
Windows:	Interior glazing shall be laminated glass

HVAC:

Inside Design Conditions:	70 degrees F (21C), 75 degrees F (24C) 30%- 50% Relative Humidity
Min. Supply Air Change/ Hr.:	6 .
Return Air:	Permitted
Exhaust Air:	Not Required
Room Noise Level:	NC 35
Individual Temperature Control:	Required

Room Air Balance: Neutral.

Electrical:

Lighting Levels:

Gen. Illumination: 30 fc

Task Illumination: 50 fc

Emerg. Illumination: As required

Telecommunications: As required

Emergency Power: Provide one source

Receptacles: As required

5.6 Nursing Station (NSTA1) - 300 NSF [27.9 NSM]
 Nurse Workroom (WRCH1) - 120 NSF [11.2 NSM]
 Medication Room (MEDP1) - 120 NSF [11.2 NSM]
 Team Room (CRA01) – 220 NSF [20.4 NSM]

Equipment Table:

See Legend of Symbols in Section 1.6

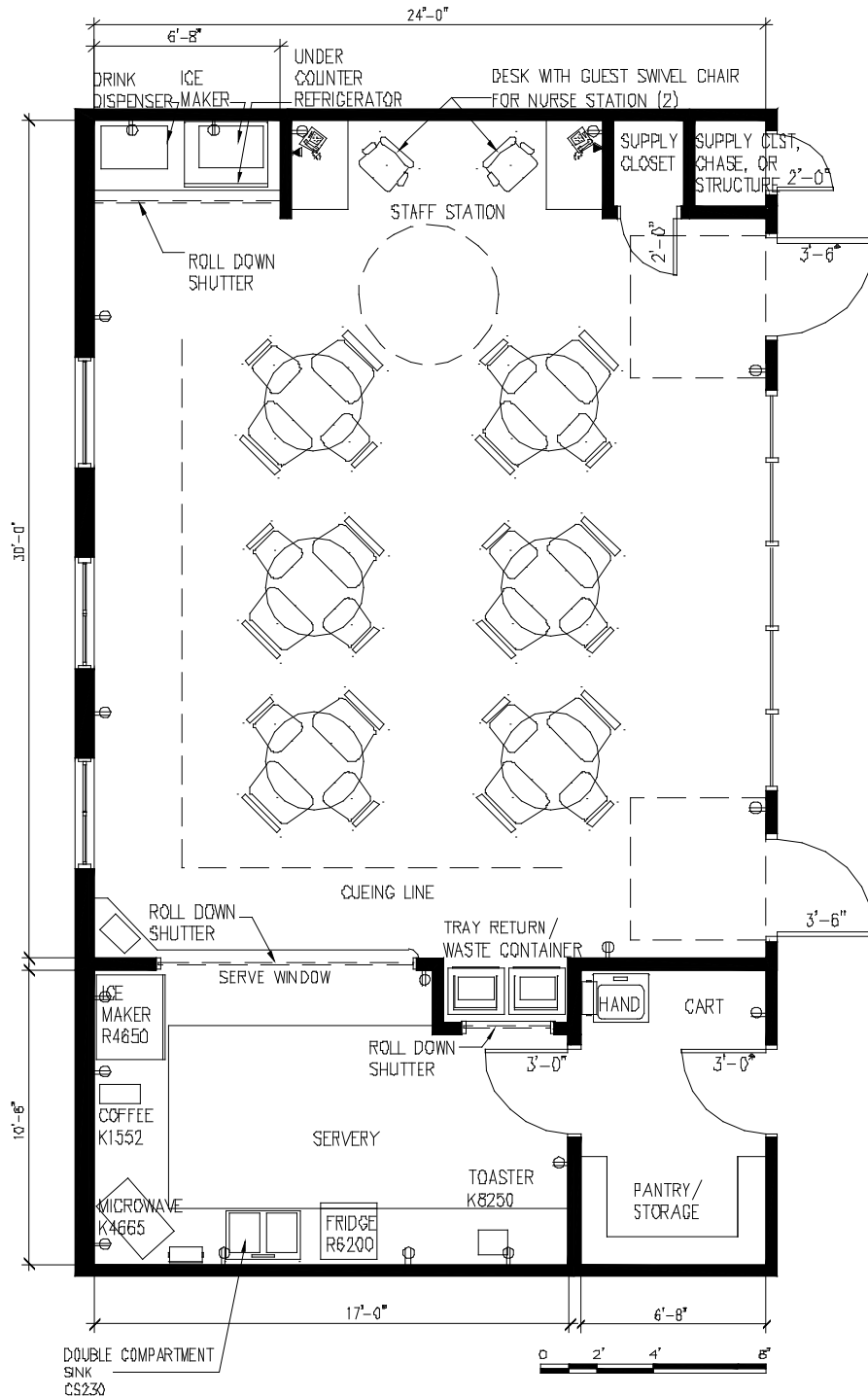
SYMBOL	QUANTITY	AI	DESCRIPTION
			<i>Note: Where VA standard items are shown, non-institutional & sustainable options should be considered if feasible.</i>
NURSING STATION (NSTA1) & NURSE WORKROOM (WRCH1)			
JSN A1010	AR	CC	TELECOMMUNICATIONS/DATA OUTLET
JSN A1015	AR	CC	TELEPHONE, DESK, MULTIPLE LINE
	1	CC	COUNTER, SOLID SURFACE, INDIVIDUAL SINGLE DRAWERS BELOW FULL LENGTH OF COUNTER AS REQUIRED, SIZE ACCORDING TO INDIVIDUAL PROJECT DESIGN
	1	CC	NURSE CALL ANNUNCIATOR AUDIO-VISUAL DESK TYPE
JSN F0280	AR	VV	LOW BACK ADJUSTABLE, CONTEMPORARY SWIVEL CHAIR, 939mm x 635mm x 787mm (37" h x 25" w X 31"d)
JSN F0420	1	VV	CABINET, FILING, LATERAL, PARTIAL HEIGHT 914 mm (36" wide)
	1	CC	FIRE ALARM STATION, RED SIGNAL LIGHT AND CHIME, WALL MOUNTED
JSN M7655	1	CC	DEFIBRILLATOR/CARDIOSCOPE, 5-LEAD
	AR	CC	RECEPTACLE, ELECTRICAL, QUADRAPLEX, FOR COMPUTER ITEMS
JSN F3200	1	W	CLOCK, BATTERY, 12" dia.
JSN A1011	AR	AA	TELEPHONE, DESK, 1 LINE
JSN F3050	1	CC	MARKER BOARD, WHITE PORCELAIN WITH CHALK TRAY, 914mm x 1218mm (36"w x 48"h)
JSN M1605	1	VV	CLINICAL CHART HOLDER CART. 20 CHART CAPACITY. 2 SIDE-BY-SIDE TIERS.
JSN F2000	AR	VV	WASTE CONTAINER - METAL 457mm x 406mm dia. (18" high X 16" dia.)
JSN M1801	AR	W	COMPUTER, MICROPROCESSING, W/FLAT PANEL MONITOR
JSN M1820	1	VV	IMPRINTER, DATA RECORD, ELECTRIC
JSN M1840	2	W	PRINTER/COPIER/FAX COMBINATION MULTIFUNCTIONAL PRINTER, FAX, SCANNER AND COPIER (PFC) ALL-IN-ONE MACHINE.

SYMBOL	QUANTITY	AI	DESCRIPTION
JSN M1810	1	VV	COPIER/PRINTER, FLOOR STANDING 45"H X 38"W X 28"D
JSN A6165	1	CC	STATION, PNEUMATIC TUBE SYSTEM
MEDICATION ROOM (MEDP1)			
JSN A1010	1	CC	TELECOMMUNICATION/DATA OUTLET
JSN A1014	1	CC	TELEPHONE, WALL MOUNTED, 1 LINE, WITH SPEAKER
JSN M1801	1	W	COMPUTER, MICROPROCESSING, W/FLAT PANEL MONITOR
	1	CC	CABINET, BASE, WITH SOLID SURFACE TOP AND STAINLESS STEEL SINK
	1	CC	CABINET WALL WITH SLOPING TOP
JSN M3150	1	W	DISTRIBUTION SYSTEM, MEDICATION, AUTOMATIC.
JSN R6200	1	W	REFRIGERATOR, MEDICATION WITH REMOTE MANAGER- OR- REFRIGERATED MEDICATION DISPENSER UNIT 35" H x 24" W x 26" D.
JSN E0957	1	VV	CART, MEDICATION, MOBILE, 68"H X 54"W X 22"D
JSN A5075	1	W	DISPENSER, SOAP,
JSN A5106	1	W	WASTE DISPOSAL UNIT, SHARPS W/GLOVE DISPENSER
JSN F2000	1	W	WASTE CONTAINER - METAL 457mm x 406mm dia. (18" high X 16" dia.)
JSN F3200	1	W	CLOCK, BATTERY, 12" dia.
JSN A5080	1	CC	PAPER TOWEL DISPENSER, SATIN FINISH STAINLESS STEEL, SINGLE-FOLD, SURFACE MOUNTED
TEAM ROOM (CRA01)			
JSN A1010	AR	CC	TELECOMMUNICATION/DATA OUTLET
JSN A1014	1	CC	TELEPHONE, WALL MOUNTED, 1 LINE, WITH SPEAKER
JSN M1801	1	W	COMPUTER, MICROPROCESSING, W/FLAT PANEL MONITOR
	1	CC	CABINET, BASE, WITH SOLID SURFACE TOP AND STAINLESS STEEL SINK
JSN F3200	1	CC	CLOCK, WALL MOUNTED, BATTERY 12" dia..
JSN F3050	1	CC	MARKER BOARD, WHITE PORCELAIN WITH CHALK TRAY, 914mm x 1218mm (36"w x 48"h)
		VV	CONFERENCE TABLE
	AR	VV	CONFERENCE CHAIRS

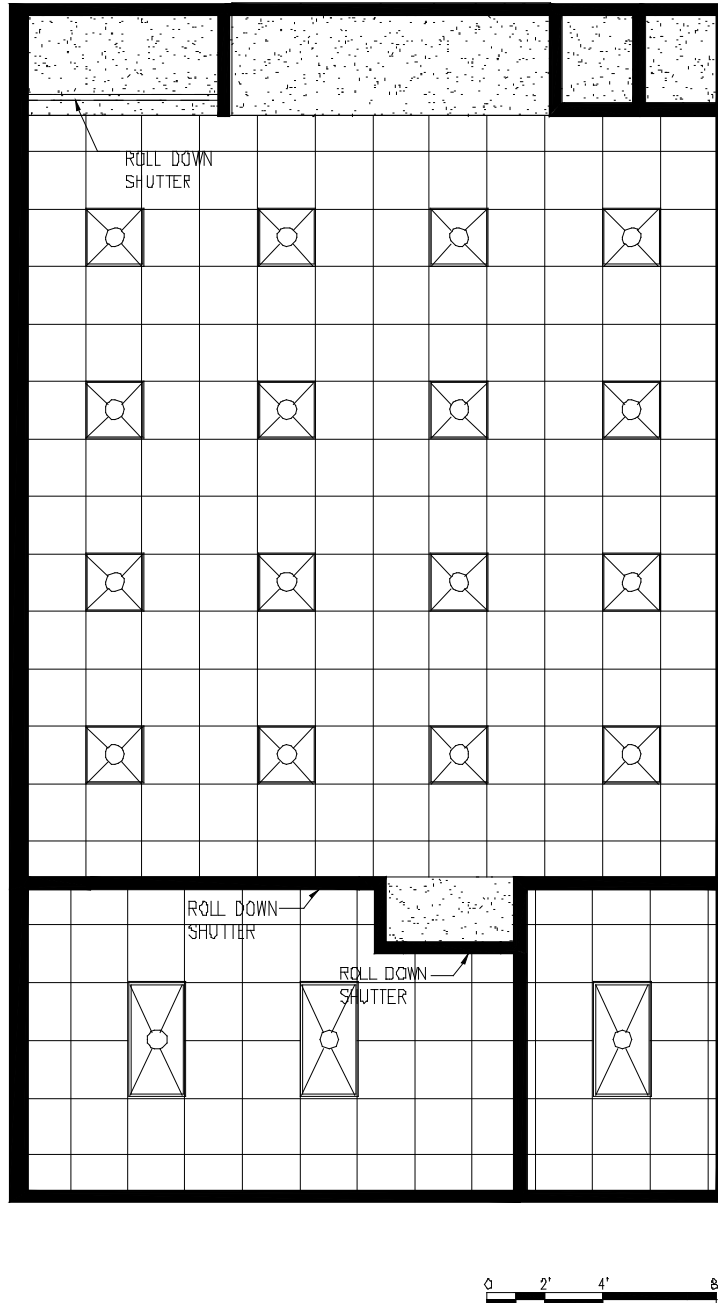
TABLE 5.6

Nursing Station / Workroom / Medication Room / Team Room

5.7 Dining Room (FSCD1) - 700 NSF [65.0 NSM]
 Serving/Pantry (FSPT1) - 235 NSF [21.8 NSM]
 Floor Plan



5.7 Dining Room (FSCD1) - 700 NSF [65.0 NSM]
Serving/Pantry (FSPT1) - 235 NSF [21.8 NSM]
Reflected Ceiling Plan



5.7 Dining Room (FSCD1) - 700 NSF [65.0 NSM] Serving/Pantry (FSPT1) - 235 NSF [21.8 NSM]

Function:

A patient dining area shall be included within each patient unit. This space shall have a staff station large enough to accommodate two people. The Dining Room should also be located near the entry to the patient unit so food service does not need to pass by patient rooms. A beverage station is located within the dining room which will have a roll down shutter to close the station during desired times. There shall be ample room to move patients around in wheelchairs and to assist bariatric patients. Separate entry and egress doors allow for a queuing line to the serving line window and the tray return.

The Serving Line will consist of two parts: the Servery and the Pantry/Storage. The Servery shall be the area where patients are being served through a window which shall have a roll down shutter to secure the area. The Pantry/Storage area is for non-food item storage such as paper plates, utensils and other disposable items, storage for a food service cart and a hand sink. This area may be co-located within the Servery area or have a dividing door.

Note: Where VA standard items are shown, non-institutional & sustainable options should be considered if feasible.

Space Requirement:

Dining Room: 700 NSF [65.0 NSM]

Serving Line: 235 NSF [21.8 NSM]

Dining Room

Architectural:

Floor Finish:	Sheet vinyl, linoleum or rubber flooring
Base:	Rubber Base
Wall Finish:	Gypsum Board
Ceiling:	Acoustic Tile with clips or gypsum board with acoustical plaster
Ceiling Height:	10'-8" preferred, 9'-6" minimum
Noise (STC Rating):	40.
Hardware:	VA Hardware #67 if applicable
Doors:	3'-6"x7'-0" if doors are used. Glazing shall be laminate glass. Metal Counter Shutter- size as required
Windows:	Laminate glazing on inside face of exterior windows and interior windows. Integral blinds recommended on exterior glazing for sun control.

HVAC:

Inside Design Conditions:	70 degrees F (21C), 75 degrees F (24C) 30%- 50% Relative Humidity
Min. Supply Air Change/ Hr.:	6
Return Air:	Permitted
Exhaust Air:	Not Required
Room Noise Level:	NC 40
Individual Temperature Control:	Required
Room Air Balance:	Neutral

Electrical:

Lighting Levels:	
Gen. Illumination:	30 fc
Task Illumination:	Not Applicable

Emerg. Illumination: As required

Telecommunications: Two (one at each staff station)
 Emergency Power: Provide at staff station and for refrigerated equipment
 Receptacles: As required (including one at each staff station)

Serving/Pantry

Architectural:

Floor Finish: Slip resistant, easily cleanable surface such as quarry or porcelain tile.
 Base: To match flooring
 Wall Finish: Epoxy Painted Gypsum Board or other non-porous surface coating or material
 Ceiling: Acoustic Tile
 Ceiling Height: 9'-0" minimum
 Noise (STC Rating): Not applicable.
 Slab Depression: Recommended based on flooring material.
 Hardware: VA Hardware #69
 Doors: 3'-0"x7'-0"

- Solid wood door with vision panel for use between Serving and Pantry
- No vision panel for door to corridor

 Metal Counter shutter between Serving and Dining
 Windows: Not required.

HVAC:

Inside Design Conditions: 70 degrees F (21C), 75 degrees F (24C)
 30%- 50% Relative Humidity
 Min. Supply Air Change/ Hr.: 6
 Return Air: Permitted
 Exhaust Air: Not Required
 Room Noise Level: NC 40
 Individual Temperature Control: Required
 Room Air Balance: Neutral

Electrical:

Lighting Levels:
 Gen. Illumination: 50 fc
 Task Illumination: N/A
 Emerg. Illumination: As required
 Emergency Power: As required
 Receptacles: As required per layout and equipment

5.7 Dining Room (FSCD1) - 700 NSF [65.0 NSM] Serving/Pantry (FSPT1) - 235 NSF [21.8 NSM]

Equipment Table:

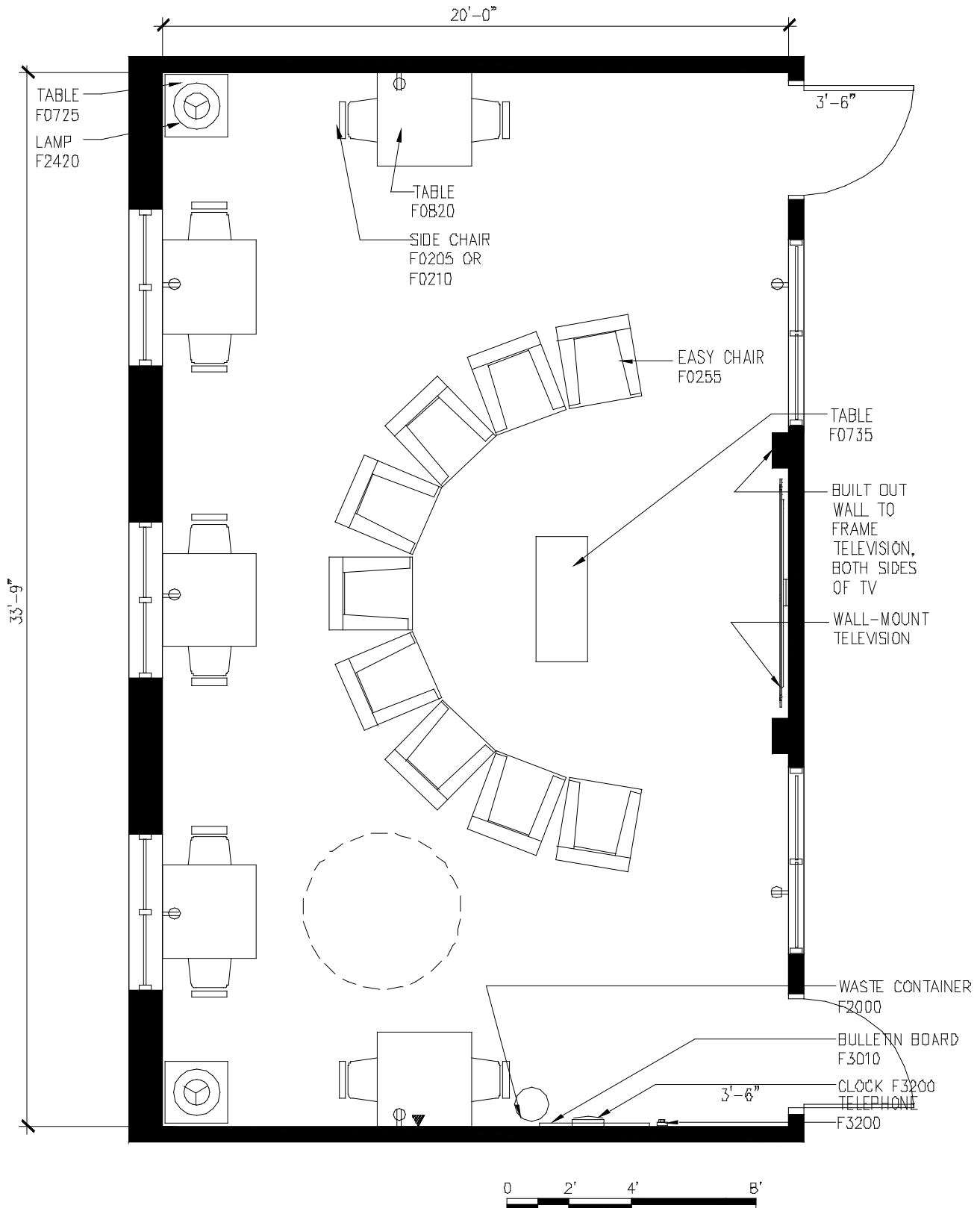
See Legend of Symbols in Section 1.6

SYMBOL	QUANTITY	AI	DESCRIPTION
			Note: Where VA standard items are shown, non-institutional & sustainable options should be considered if feasible.
JSN A1010	2	CC	TELECOMMUNICATIONS/DATA OUTLET.
JSN A1012	2	CC	TELEPHONE, WALL MOUNTED, 1 LINE
JSN F0225	AR	W	CHAIR, DINING, 1015mm x 482mm x 609mm,(40"h x 19"w x 24" d)
NO JSN	AR	W	CHAIR, BARIATRIC, 50% OF TOTAL, 1015mm x 660mm x 609mm (40"h x 26" w x 24"d)
JSN F0795	AR	VV	TABLE, PEDASTAL, ROUND 1066 mm dia (42" dia.)
JSN A6046	AR	VV	ARTWORK, WALL MOUNTED, SECURELY FASTENED
F3200	1	VV	CLOCK, BATTERY, 305mm dia. (12" dia.)
JSN R4650	1	CC	ICE MAKER, FLAKED, WITH DISPENSER, 1802mm x 482mm x 609mm (71"h x 19"w x24"d)
	AR	CC	COUNTER FOR ICEMAKER WITH DRAWERS & CABINETS BELOW FOR STORAGE
NOURISHMENT STATION (NCWD1)			
JSN A5075	1	CC	SOAP DISPENSER
JSN A5080	1	CC	PAPER TOWEL DISPENSER, SATIN FINISH STAINLESS STEEL, SINGLE-FOLD, SURFACE MOUNTED
JSN CS230		CC	SINK, SS, DOUBLE COMPARTMENT, 254mm x 355mm x 406mm (10"d x14" w x 16"l)
JSN R4650	1	CC	ICE MAKER, FLAKED, WITH DISPENSER, 1802mm x 482mm x 609mm (71"h x 19"w x24"d)
NO JSN	2		TRASH CAN HOUSING WITH TRAY RETURN ON TOP TO HOLD 32 GALLON TRASH CAN
JSN K1552	1	W	BREWER, COFFEE, AUTO, ELECT, 3 BURNER, FRONT/BACK
JSN R6200	1	W	UNDERCOUNTER REFRIGERATOR, LOCKABLE
JSN K4665	1	W	OVEN, MICROWAVE, CONSUMER
JSN K8250	1	W	TOASTER, POP-UP, 4 SLICE, ELECTRIC
NO JSN		CC	BASE CABINETS-PLASTIC LAMINATE/COUNTER SOLID SURFACE
			FOOD DELIVERY CART

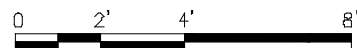
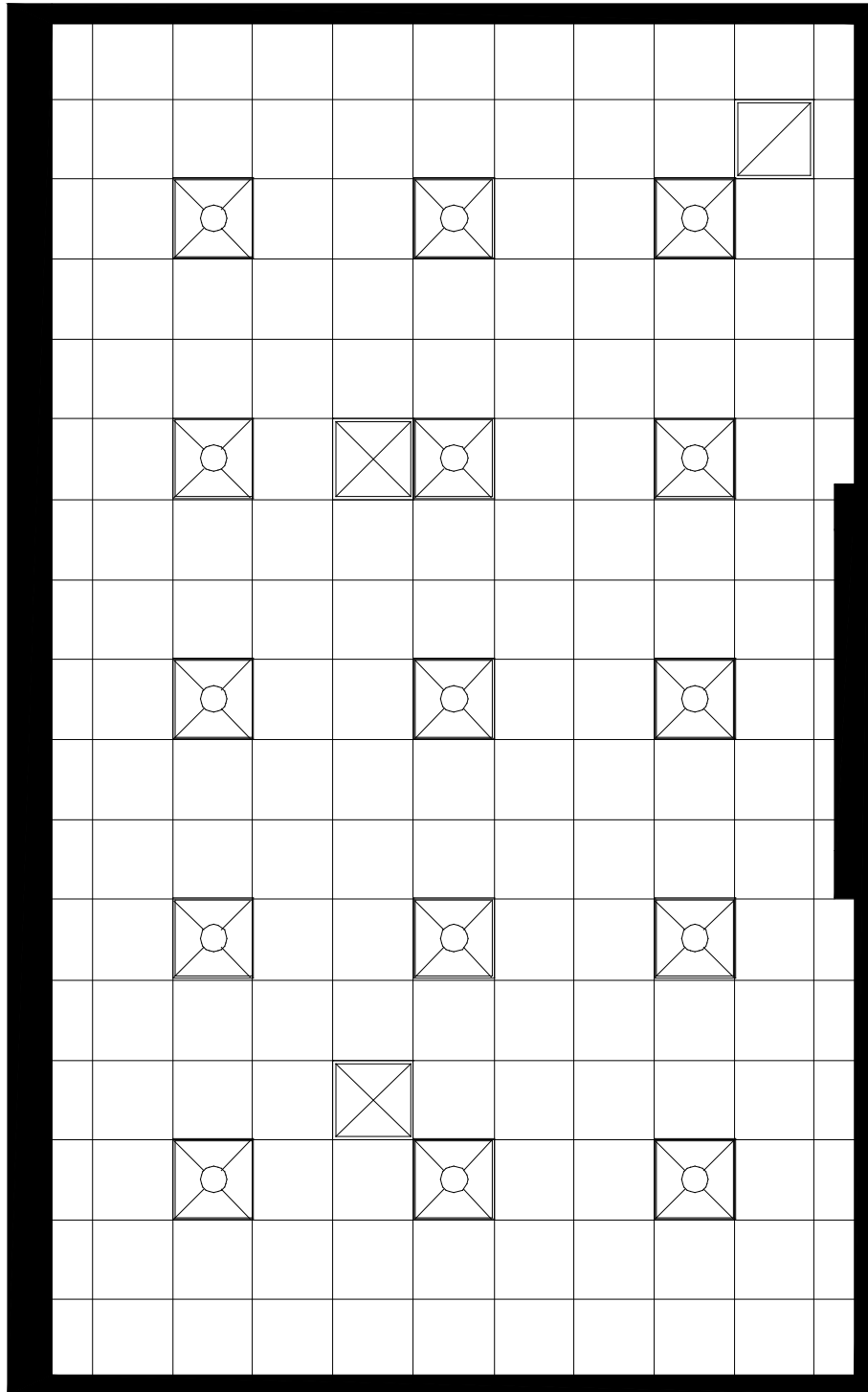
NO JSN			SHELVING, ADJUSTABLE FOR STORAGE IN PANTRY AREA, 305 mm (12" d),
--------	--	--	--

TABLE 5.7
Dining Room/ Serving/Pantry

5.8 Day Room (DAYR1) - 675 NSF [62.7 NSM] Floor Plan



5.8 Day Room (DAYR1) - 675 NSF [62.7 NSM] Reflected Ceiling Plan



5.8 Day Room (DAYR1) - 675 NSF [62.7 NSM]

Function:

This space acts as the “living room” for the unit. This space may be subdivided into two, or three areas, one quiet and one for television viewing and other more active activities. Television viewing areas and sub dayrooms should be enclosed for noise control and privacy.

Seating should be attractive and comfortable but not readily picked up and thrown. Individual seating is preferred throughout. Table lamps or hanging lamp fixtures, loose accessories and coffee tables should not be used.

Note: Where VA standard items are shown, non-institutional & sustainable options should be considered if feasible.

Space Requirement:

675 NSF [62.7 NSM]

Architectural:

Floor Finish:	Carpet, carpet tiles or resilient flooring
Base:	Rubber Base
Wall Finish:	Gypsum Board
Ceiling:	Acoustical Tile with clips or Gypsum board with Acoustical Plaster
Ceiling Height:	10'-8" preferred, 9'- 6" minimum
Noise (STC Rating):	STC 40, STC 45 between this room and patient rooms or group therapy rooms
Hardware:	VA Hardware #67 if applicable
Doors:	3'-6" x 7'-0" wood or metal, with laminate glass ½ lite view panel.
Windows:	Laminate glazing on inside face of exterior windows and interior windows. Integral blinds recommended on exterior glazing for sun control.

HVAC:

Inside Design Conditions:	70 degrees F (21C), 75 degrees F (24C) 30%- 50% Relative Humidity
Min. Supply Air Change/ Hr.:	6
Return Air:	Permitted
Exhaust Air:	Not Required
Room Noise Level:	NC 40
Individual Temperature Control:	Required
Room Air Balance:	Neutral

Electrical:

Lighting Levels:	
Gen. Illumination:	30 fc
Task Illumination:	50 fc
Emerg. Illumination:	As required
Telecommunications:	As required
Emergency Power:	As required
Receptacles:	As required

5.8 Day Room (DAYR1) - 675 NSF [62.7 NSM]

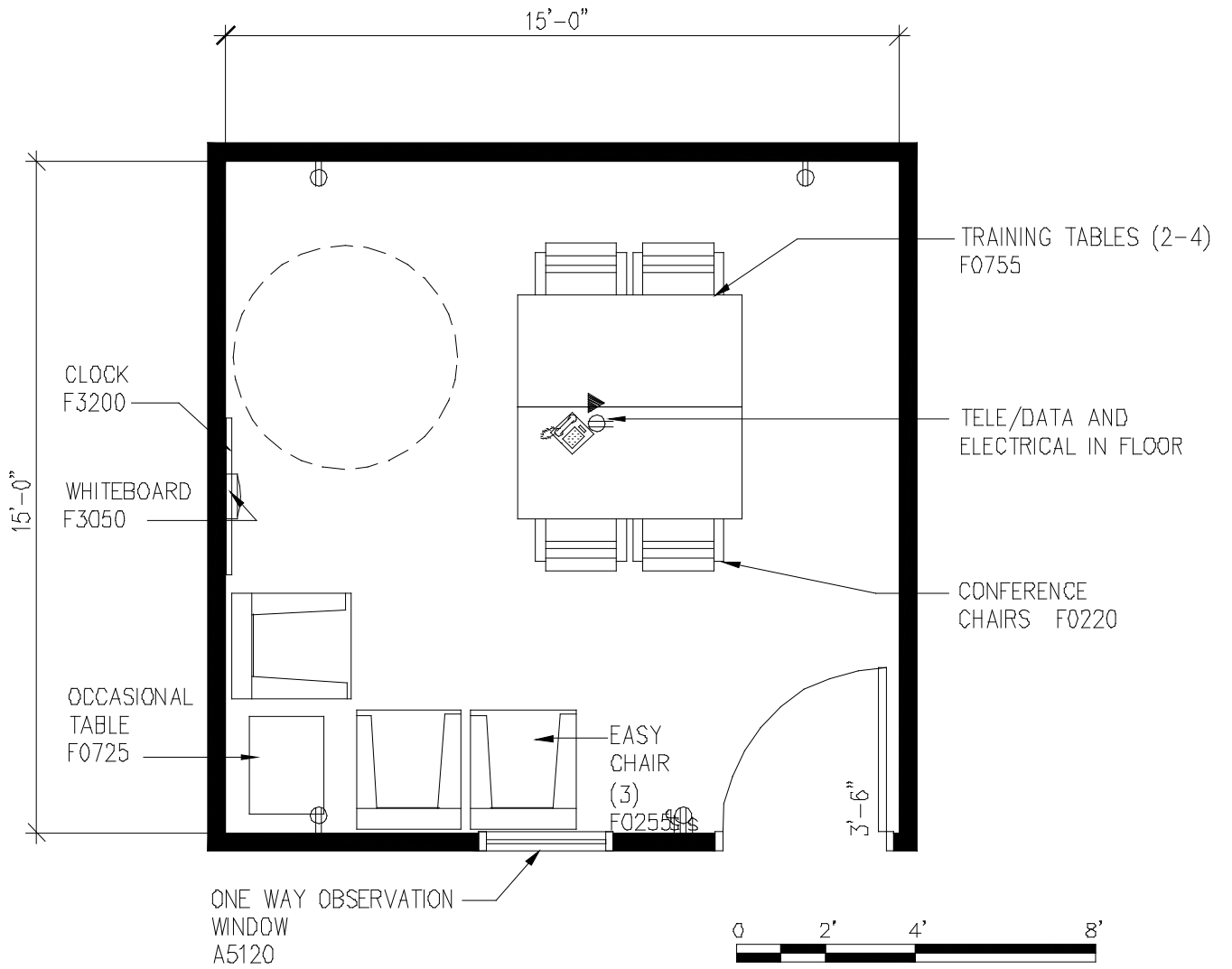
Equipment Table:

See Legend of Symbols in Section 1.6

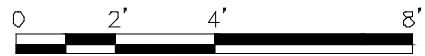
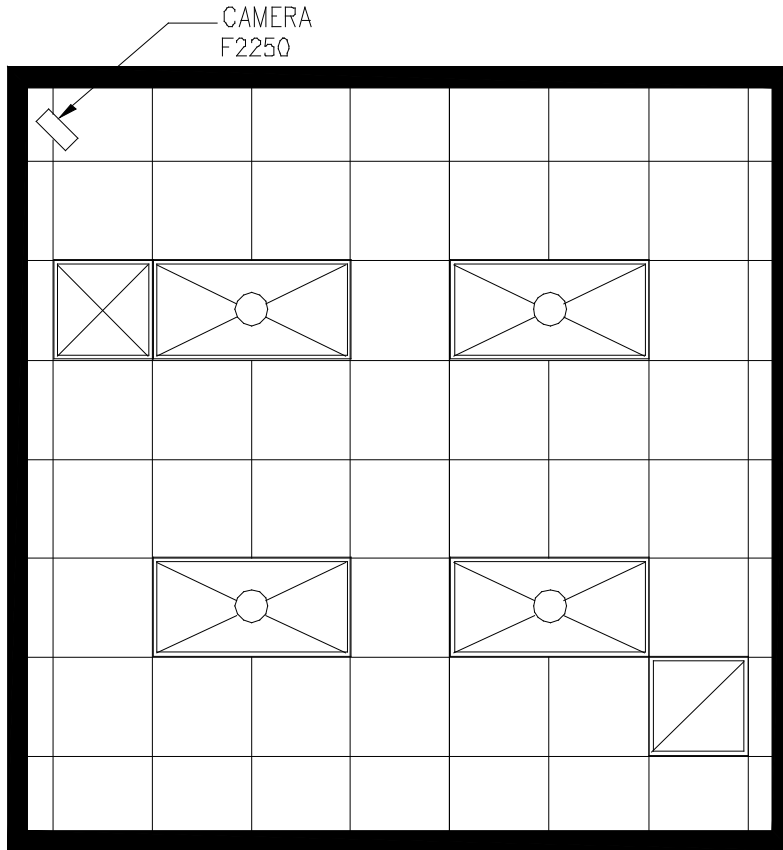
SYMBOL	QUANTITY	AI	DESCRIPTION
			Note: Where VA standard items are shown, non-institutional & sustainable options should be considered if feasible.
JSN A1010	1	CC	TELECOMMUNICATIONS/DATA OUTLET
JSN A1011	1	CC	TELEPHONE, WALL MOUNTED, 1 LINE
JSN A5220	1	CC	BRACKET, TELEVISION WALL BACKING
JSN A6046	AR	W	ARTWORK, SECURELY FASTENED TO WALL
JSN F0205	AR	W	CHAIR, SIDE WITH ARMS 914mm x 584mm x 685mm (36" h x 23" w x 27" d)
JSN F0210	AR	W	CHAIR, SIDE WITHOUT ARMS 914mm x 533mm x 558mm (36" h x 21" w x 22" d)
JSN F0255	AR	W	CHAIR, EASY WITH ARMS AND FLOOR GLIDES. 888mm x 711mm x 812mm (35" h x 28" w x 32" d)
JSN F0725	AR	W	TABLE, OCCASIONAL, 534mm x 660mm x 508mm (21" h x 26" w x 20" d).
JSN F0735	AR	W	COFFEE TABLE, 457mm x 1320mm x 609mm (18" h x 52" w x 24" d)
	AR		TABLE, OFFICE, SQUARE 1066mm X 761mm (42"sq. X 30"h)
JSN F2000	1	VV	WASTE CONTAINER, PLASTIC, 457mm x 406mm dia.(18" high X 16" dia.)
JSN F3010	1	CC	BOARD, BULLETIN, SECURELY FASTENED TO WALL 1218mm x 1218mm (48"h x 48"w)
NO JSN	1	VV	TV PLASMA FOR WALL MOUNT, 812mm x 1244mm (32"h x 49"w)
JSN F3200	1	W	CLOCK, BATTERY, 305mm (12" dia.)
JSN F0250	AR	VV	CHAIR, LOUNGE WITH ARMS, 888mm x 711mm x 812mm (35" h x 28" w x 32" d)

TABLE 5.9
Day Room

5.9 Group Room (OPMH1) - 225 NSF [20.9 NSM] Floor Plan



5.9 Group Room (OPMH1) - 225 NSF [20.9 NSM] Reflected Ceiling Plan



5.9 Group Room (OPMH1) - 225 NSF [20.9 NSM]

Function: The function and use of this space will vary depending on the type of patient housed in the unit. Typically, this room will be used for group educational sessions and can be used for limited computer access for patients based in individual treatment plans. This room should be directly observed from the Nurse's station and can be locked when not in use.

Note: Where VA standard items are shown, non-institutional & sustainable options should be considered if feasible.

Space Requirement:

225 NSF [20.9 NSM]

Architectural:

Floor Finish:	Carpet, Carpet tiles or resilient flooring
Base:	Rubber Base
Wall Finish:	Gypsum Board (2 layers) with painted finish
Ceiling:	Acoustic Tile with clips or gypsum board with acoustical plaster
Ceiling Height:	10'-8" preferred, 9'-6" minimum
Noise (STC Rating):	STC 45.
Hardware:	VA Hardware Group # 52
Doors:	3'-6" x 7'-0" wood or metal, with laminate glass view panel.
Windows:	Laminate glazing on inside face of exterior windows and interior windows. Integral blinds recommended on exterior glazing for sun control.

HVAC:

Inside Design Conditions:	70 degrees F (21C), 75 degrees F (24C) 30%- 50% Relative Humidity
Min. Supply Air Change/ Hr.:	6
Return Air:	Permitted
Exhaust Air:	Not Required
Room Noise Level:	NC 35
Individual Temperature Control:	Required
Room Air Balance:	Neutral

Electrical:

Lighting Levels:	
Gen. Illumination:	30 fc Task Illumination: N/A
Emerg. Illumination:	As required
Telecommunications:	1 in floor under center of table
Emergency Power:	As required
Medical Gases:	N/A
Receptacles:	5 per room (including 1 in floor under center of table)
Nurse Call:	N/A

5.9 Group Room (OPMH1) - 225 NSF [20.9 NSM]

Equipment Table:

See Legend of Symbols in Section 1.6

SYMBOL	QUANTITY	AI	DESCRIPTION
			Note: Where VA standard items are shown, non-institutional & sustainable options should be considered if feasible.
JSN A1010	1	CC	TELECOMMUNICATIONS/DATA OUTLET
JSN A1012	1	CC	TELEPHONE, WALL MOUNTED, 1 LINE
JSN A5120	1	CC	WINDOW, OBSERVATION, ONE WAY WINDOW FRAME MOUNTED INSIDE WALL OPENING ON AN ALUMINUM FRAME. SIZE AS REQUIRED.
JSN A6330	1	CC	INTERCOM - ROOM TO ROOM (NOT SHOWN)
JSN F0220	AR	W	CHAIR, CONFERENCE 914mm x 533mm x 558mm (36"h x 21" w x 22" d)
JSN F0255	7	W	CHAIR, EASY WITH ARMS AND FLOOR GLIDES. 888mm x 711mm x 812mm (35" h x 28" w x 32" d)
JSN F0755	1	W	TABLE, CONFERENCE, WOOD 761mm x 1218mm (30"h x 48" w x VARYING LENGTHS)
JSN F2250	1	W	CAMERA, PORTABLE, CCTV, WITH RECORDER PORTABLE CAMERA/RECORDER (CAMCORDER) WITH VIDEO-OUT CAPACITY TO ACCOMMODATE A REMOTE RECORDER.

TABLE 5.9
Group Room

(This page intentionally left blank)



Department of
Veterans Affairs



Office of Construction &
Facilities Management

Section 6

MENTAL HEALTH RESIDENTIAL REHABILITATION
TREATMENT PROGRAM FACILITY

MENTAL HEALTH FACILITIES DESIGN GUIDE



6.0 Mental Health Residential Rehabilitation Treatment Program (MH RRTP) Facility

General Note: Technical data included in these room templates reflects VA standards at the time this Design Guide was issued. Designers should refer to the latest VA technical documents for updated mechanical, electrical and other criteria that may be at a variance with the data listed in this Design Guide.

Design Guide Section No.	Room Name	Room Code	Current Space Criteria NSF [NSM]
6.1	Two Bedroom Suite:		
	Bedroom, One Bed, Standard	BRLC1	100 NSF [9.3 NSM]
	Bedroom, One Bed, Accessible	BRLC3	120 NSF [11.2 NSM]
	Bathroom, Two Bed Suite, Accessible		100 NSF [9.3 NSM]
	Vestibule Suite	BRAR2	50 NSF [4.7 NSM]
6.2	Bedroom, One-Bed, Standard	BRLC1	100 NSF [9.3 NSM]
	Bathroom, Standard, One Person	TLTS2	50 NSF [4.7 NSM]
6.3	Bedroom, One-Bed, Accessible	BRLC3	150 NSF [14.0 NSM]
	Bathroom, Accessible	TLTS2	65 NSF [6.0 NSM]
6.4	Bedroom, One-Bed, Bariatric	BRNP1	180 NSF [16.7 NSM]
	Bathroom, Bariatric	TLTS2	75 NSF [7.0 NSM]
6.5	Bedroom, Two-Bed, Standard	BRNC2	200 NSF [18.6 NSM]
	Bathroom, Two-Bed, Standard	TLTS2	75 NSF [7.0 NSM]
6.6	Resident Living Unit Suite:		
	Resident Living Unit: Living Area	DAYR1	150 NSF [13.9 NSM]
	Resident Living Unit: Dining Area	FSCD1	120 NSF [11.2 NSM]
	Resident Living Unit: Kitchenette	IPK01	90 NSF [8.4 NSM]
	Resident Living Unit: Storage	SRS01	100 NSF [9.3 NSM]
6.7	Lounge, Resident	DAYR1	560 NSF [52.1]
6.8	Multi-Purpose Room / Kitchenette	IPK01	400 NSF [37.2 NSM]
6.9	Resident Education / Conference / Group Room	DAYR1	300 NSF [27.9 NSM]
6.10	Nutrition & Food Service		
	Dining Room	FSCD1	700 NSF [65.0 NSM]
	Serving Line w/ Pantry Storage	FSPT1	235 NSF [21.8 NSM]
	Training Kitchen	IPK01	290 NSF [26.9 NSM]
6.11	Recreation Therapy Room	DAYR1	300 NSF [27.9 NSM]

6.1 Two Bedroom Suite:

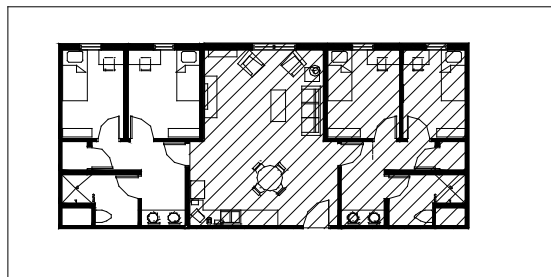
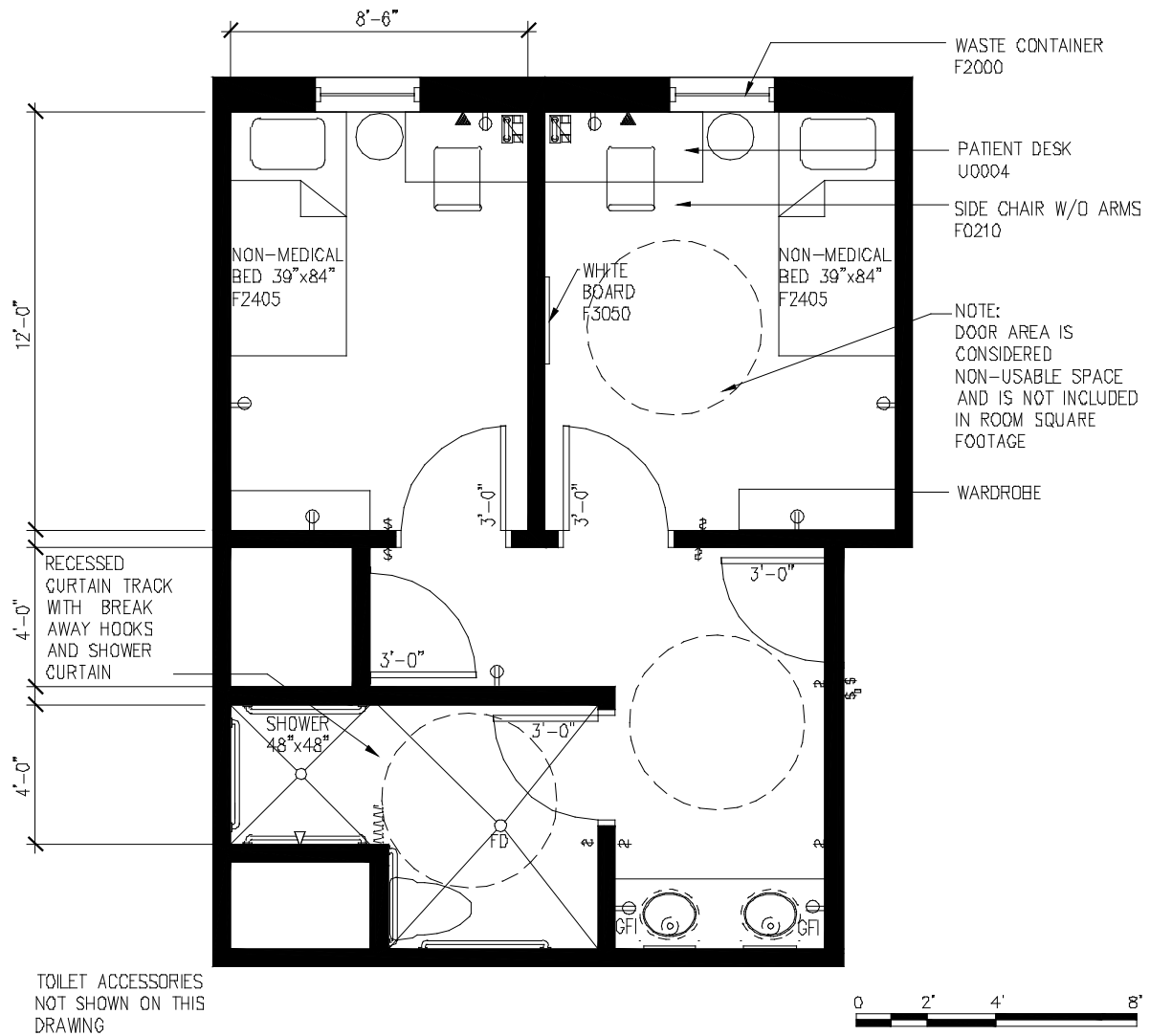
Bedroom, One Bed, Standard (BRLC1) - 100 NSF [9.3 NSM]

Bedroom, One Bed, Accessible (BRLC3) - 120 NSF [11.2 NSM]

Bathroom, Two Bed Suite, Accessible - 100 NSF [9.3 NSM]

Vestibule, Suite (BRAR2) - 50 NSF [4.7 NSM]

Floor Plan



KEY PLAN:
SEE 6.6 FOR RESIDENT LIVING SUITE

6.1 Two Bedroom Suite:

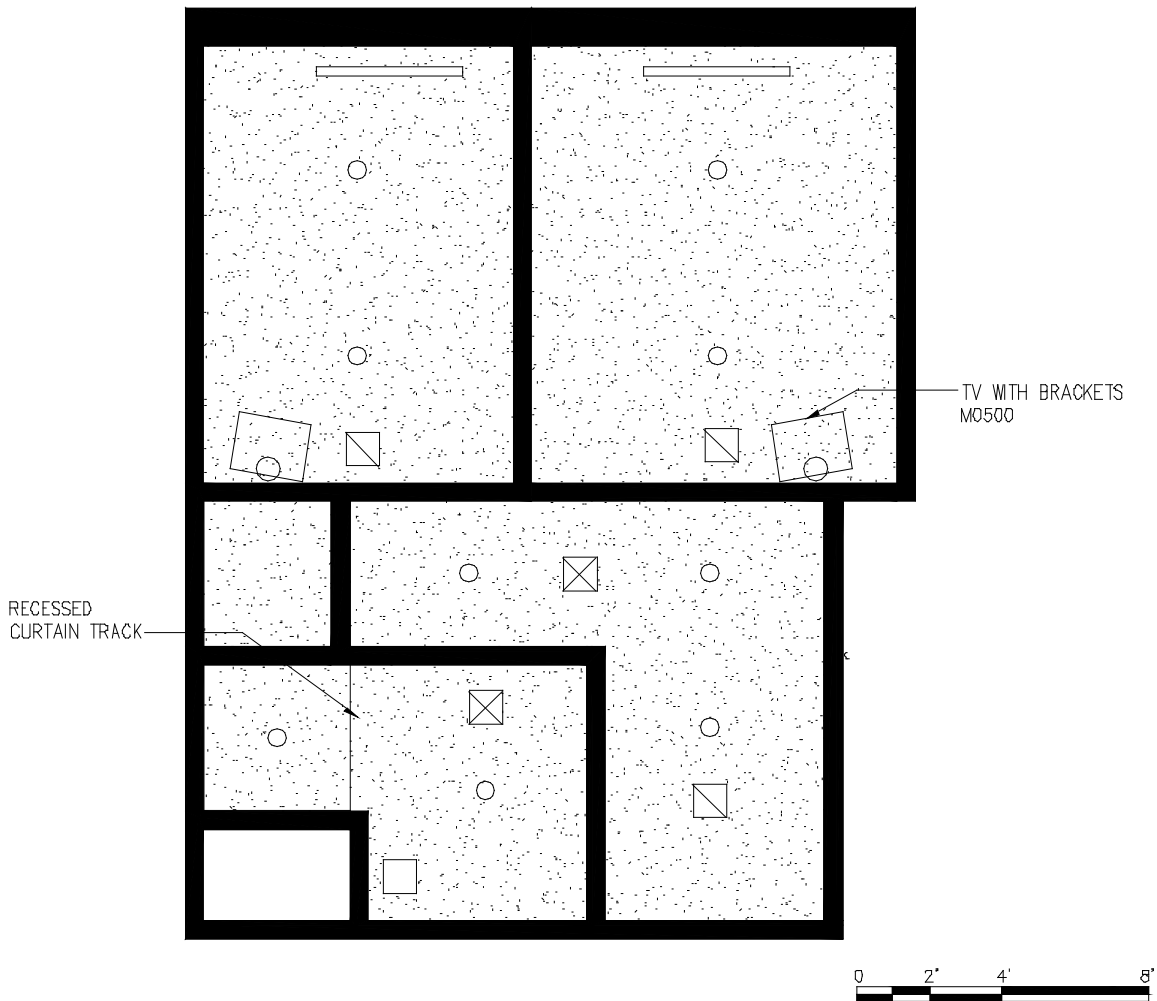
Bedroom, One Bed, Standard (BRLC1) - 100 NSF [9.3 NSM]

Bedroom, One Bed, Accessible (BRLC3) - 120 NSF [11.2 NSM]

Bathroom, Two Bed Suite, Accessible - 100 NSF [9.3 NSM]

Vestibule, Suite (BRAR2) - 50 NSF [4.7 NSM]

Reflected Ceiling Plan



6.1 Two Bedroom Suite:

Bedroom, One Bed, Standard (BRLC1) - 100 NSF [9.3 NSM]

Bedroom, One Bed, Accessible (BRLC3) - 120 NSF [11.2 NSM]

Bathroom, Two Bed Suite, Accessible - 100 NSF [9.3 NSM]

Vestibule, Suite (BRAR2) - 50 NSF [4.7 NSM]

Function:

Single Occupancy Bedrooms comprise 75% of the bed space of a typical MH RRTP facility or unit. A minimum of 20% of the total bed space in a MH RRTP unit should be accommodated in one bed, resident bedrooms illustrated in guide plate 6.2. All other single occupancy rooms should be accommodated in standard resident rooms illustrated in this guide plate. These resident rooms are intended to share a bathroom as part of a suite arrangement. This suite may or may not be connected to a resident living unit shared by another bedroom suite. .

Note: Where VA standard items are shown, non-institutional & sustainable options should be considered if feasible.

Space Requirement:

Bedroom, One Bed, Standard: 100 NSF [9.3 NSM]

Bedroom, One Bed, Accessible: 120 NSF [11.2 NSM]

Vestibule, Suite: 50 NSF [4.7 NSM]

Bedroom Suite

Architectural:

Floor Finish:	Sheet vinyl, linoleum or rubber flooring.
Base:	Rubber Base (Upgraded rubber base with molding profile recommended)
Wall Finish:	Gypsum Board, painted finish
Ceiling:	Gypsum Board, painted finish
Ceiling Height:	9'-0" preferred, 8'-0" minimum
Noise (STC Rating):	STC 40 minimum, STC 45 recommended
Hardware:	See Section 3 for general guidelines
Doors:	3'-0" x 7'-0" wood.
Windows:	Required by code, see PG-18-3, Topic 1, Codes and Standards. Window unit shall have integral blinds for sun control located between layers of glazing. Inside layer shall be laminated glass. If operable, window unit must not open more than 4"

HVAC:

Inside Design Condition:	70 degrees F (21C) to 75 degrees F (24C) year round 30% - 50% Relative Humidity
Min. Air Supply Air Change/Hr:	6
Return Air:	Permitted
Exhaust Air:	Not Required
Room Noise Level:	NC 35
Individual Temperature Control:	Required
Room Air Balance:	Neutral

Electrical:

Lighting Levels:

- Gen. Illumination: 5 fc (Fluorescent recessed cans with full plastic cover and secure fasteners)
- Task Illumination: 50 fc at bed and desk- may be provided by lamps furnished by others
- Emerg. Illumination: Provide one emergency light
- Night Illumination: Low level lighting for wayfinding to the bathroom.

Emergency Power:

Provide one source

Telecommunications:

One outlet

Receptacles:

4 duplex per room and shall be tamper-resistant or equipped with ground-fault circuit interrupters (GFCI's)

Bathroom Suite**Architectural:**

- Floor Finish: 2" x 2" Ceramic Tile
- Base: 2" x 2" Ceramic Tile
- Wall Finish: Gypsum Board (epoxy paint) with full height ceramic tile on backer board at shower,
- Ceiling: Gypsum Board (epoxy paint)
- Ceiling Height: 9'-0" recommended, 8'-0" minimum
- Noise (STC Rating): STC 40 minimum, STC 45 recommended
- Slab Depression: 3" recommended for slope to shower drain
- Hardware: VA Hardware Set #14
- Doors: 3'-0" x 7'-0" wood.
- Windows: Not required.

HVAC:

- Inside Design Condition: Conditioned by make-up air from adjacent space
- Min. Air Supply Air Change/Hr: Not Applicable
- Return Air: Not Permitted
- Exhaust Air: Highest of 10 air changes/hr, 50 CFM, or room air balance.
- Room Noise Level: NC 35
- Individual Temperature Control: Not Required
- Room Air Balance: Double negative

Electrical:

Lighting Levels:

- Gen. Illumination: 30 fc
- Task Illumination: 50 fc over lavatories (space adjacent)
- Night Illumination: Low level lighting for wayfinding.
- Emerg. Illumination: Provide one source

Emergency Power:

Not Applicable

Receptacles:

2 GFCI

6.1 Two Bedroom Suite:

Bedroom, One Bed, Standard (BRLC1) - 100 NSF [9.3 NSM]

Bedroom, One Bed, Accessible (BRLC3) - 120 NSF [11.2 NSM]

Bathroom, Two Bed Suite, Accessible - 100 NSF [9.3 NSM]

Vestibule, Suite (BRAR2) - 50 NSF [4.7 NSM]

Equipment Table:

See Legend of Symbols in Section 1.6

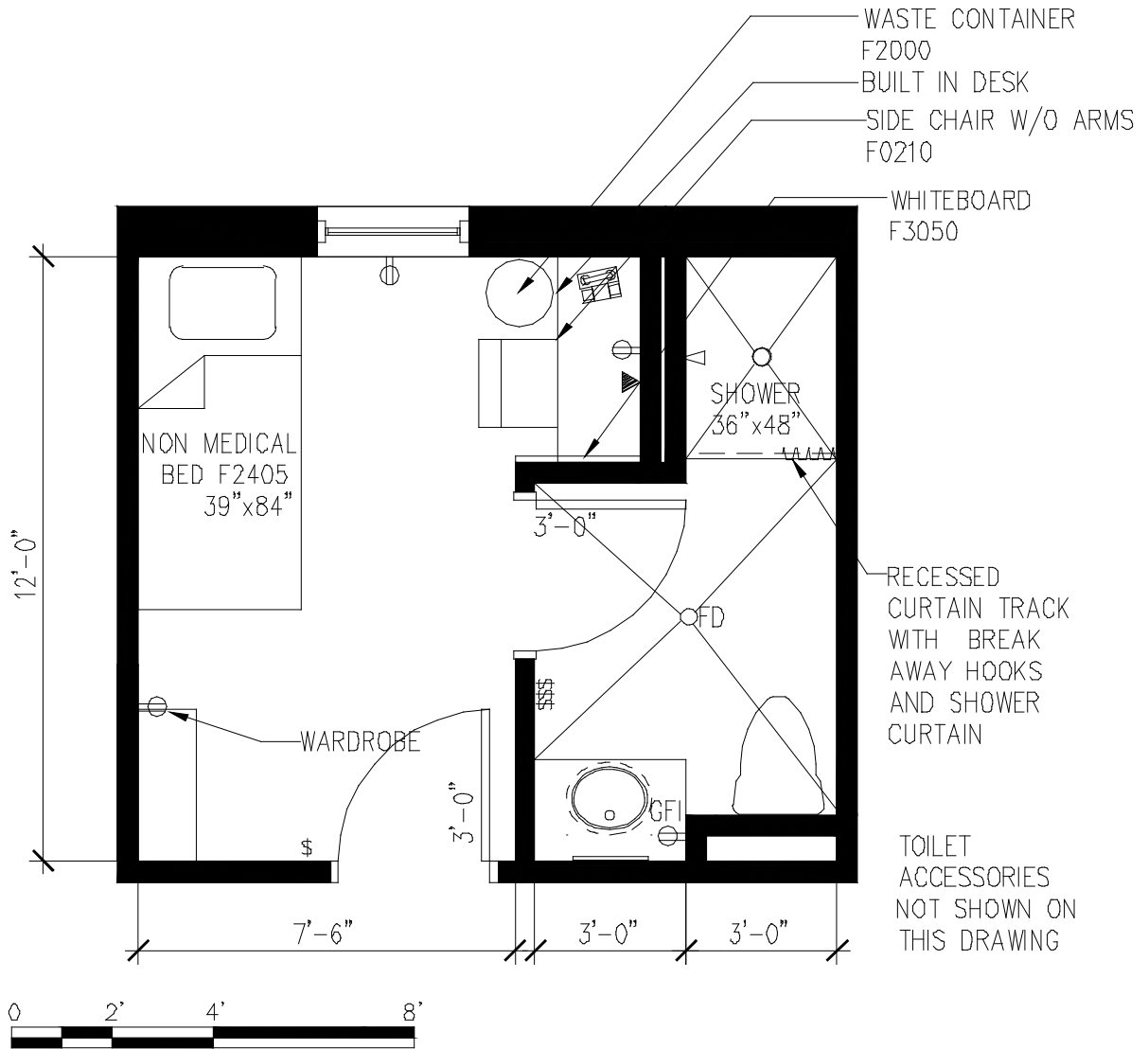
SYMBOL	QUANTITY	AI	DESCRIPTION
			<i>Note: Where VA standard items are shown, non-institutional & sustainable options should be considered if feasible.</i>
BEDROOM, RESIDENT, ONE BED, STANDARD (BRLC1)			
JSN F2405	1	VV	BED, NON-MEDICAL SINGLE 1015mm x 2106mm x 457mm (40"w x 83"l x 18"h)
JSN F0210	1	VV	SIDE CHAIR, NON-TILTING, NO ARMS, UPHOLSTERED 812mm x 482mm x 584mm (32"h x 19"w x 23"d)
JSN A1010	1	CC	TELECOMMUNICATION/DATA OUTLET
JSN A1011	1	CC	TELEPHONE, DESK, 1 LINE
NO JSN	1	VV	DESK WITH 3 DRAWERS 761mm x 1066mm x 609mm (30" h x 42" w X 24" d)
NO JSN	1	VV	WARDROBE, WITH 4 DRAWERS 1371mm x 1218mm x 457mm (54" h x 48" w x 18" d)
JSN F2000	1	VV	WASTE CONTAINER, PLASTIC 457mm x 406mm dia. (18" h x 16" dia.)
JSN F3050	1	CC	MARKER BOARD, WHITE PORCELAIN 457mm x 609mm (18" h x 24" w)
JSN M0500	1	VV	TELEVISION, COLOR, 508mm diag. (20" diag.)
JSN M0505	1		TV BRACKETS FOR WALL MOUNT
BATHROOM, RESIDENT, SUITE (TLTS2):			
JSN A1085	2	CC	MIRROR, STAINLESS STEEL FRAME WITH PLEXIGLASS, 457mm x 914mm (36"h x 18"w)
JSN A5075	1	VV	DISPENSER, SOAP, DISPOSABLE
JSN UA5145	AR	CC	COLLAPSIBLE HOOK, CLOTHES
JSN U5170	1	CC	COLLAPSIBLE ROD, SHOWER CURTAIN, 1" dia., W/CURTAIN & HOOKS
JSN A5200	1	CC	TOILET TISSUE HOLDER
JSN F2000	1	VV	WASTE CONTAINER, PLASTIC 457mm x 406mm dia. (18" h x 16" dia.)
JSN P5040	1	CC	SHOWER, SINGLE, HAND-HELD

SYMBOL	QUANTITY	AI	DESCRIPTION
JSN P9050	1	CC	TOILET, WALL HUNG, SIPHON JET
NO JSN	1	CC	VANITY, WITH SOLID SURFACE COUNTER TOP, MOLDED SELF EDGE AND BACKSPLASH; AND 2 INTEGRAL LAVATORIES, 1522mm (60" l)
	1	CC	SHOWER: SOAP DISH, RECESSED

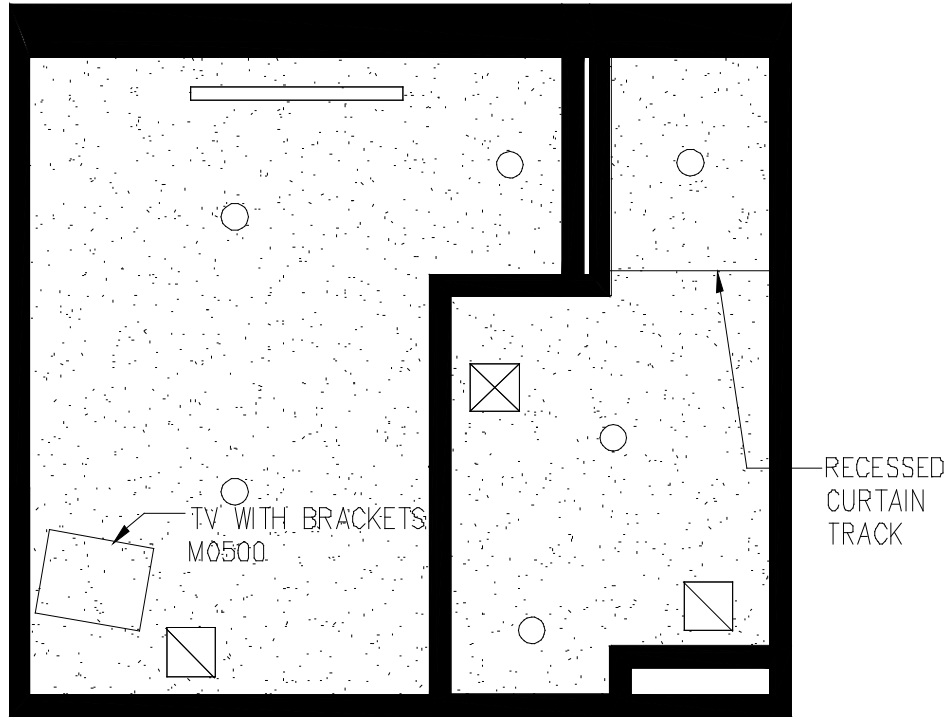
Table 6.1

Two Bedroom Suite: Bedroom, One Bed, Standard/Bedroom, One Bed, Accessible/Bathroom, Two Bed Suite, Accessible/Suite, Vestibule

6.2 Bedroom, One Bed, Standard (BRUN1) - 100 NSF [9.3 NSM]
 Bathroom, Standard (TLTS2) - 50 NSF [4.7 NSM]
 Floor Plan



6.2 Bedroom, One Bed, Standard (BRUN1) - 100 NSF [9.3 NSM]
Bathroom, Standard (TLTS2) - 50 NSF [4.7 NSM]
Reflected Ceiling Plan



6.2 Bedroom, One Bed, Standard (BRUN1) - 100 NSF [9.3 NSM] Bathroom, Standard (TLTS2) - 50 NSF [4.7 NSM]

Function:

Single Occupancy Bedrooms comprise 75% of the bed space of a typical MH RRTP facility. A minimum of 20% total bedspace should be accessible. These rooms are designed to accommodate six general classifications of residents: addiction treatment, homeless, health maintenance, post traumatic stress disorder and traumatic brain injury. For operational flexibility, a universal room design should accommodate all these resident classifications. The patient bathroom is located within the room in this option.

Note: Where VA standard items are shown, non-institutional & sustainable options should be considered if feasible.

Space Requirement:

Bedroom, Resident, One Bed, Standard: 100 [9.3 NSM]

Bathroom, Resident, Standard: 60 NSF [5.6 NSM]

Bedroom

Architectural:

Floor Finish:	Sheet vinyl, linoleum or rubber flooring.
Base:	Rubber Base (Upgraded rubber base with molding profile recommended)
Wall Finish:	Gypsum Board, painted finish
Ceiling:	Gypsum Board, painted finish
Ceiling Height:	9'-0" preferred, 8'-0" minimum
Noise (STC Rating):	STC 40 minimum, STC 45 recommended
Hardware:	See Section 3 for general guidelines
Doors:	3'-6" x 7'-0" wood recommended. 3'-0" minimum width
Windows:	Required by code, see PG-18-3, Topic 1, Codes and Standards. Window unit shall have integral blinds for sun control located between layers of glazing. Inside layer shall be laminated glass. If operable, window unit must not open more than 4"

HVAC:

Inside Design Condition:	70 degrees F (21C) to 75 degrees F (24C) year round 30%- 50% relative humidity
Min. Air Supply Air Change/Hr:	6
Return Air:	Permitted
Exhaust Air:	Through connecting bathroom
Room Noise Level:	NC 35
Individual Temperature Control:	Required
Room Air Balance:	Positive with respect to bathroom, Neutral with respect to corridor.

Electrical:

Lighting Levels:	
Gen. Illumination:	5 fc
Task Illumination:	50 fc at bed and desk- may be provided by lamps furnished by others
Emerg. Illumination:	Provide one emergency light
Night Illumination:	Low level lighting for wayfinding to the bathroom.
Emergency Power:	Provide one source
Telecommunications:	One outlet
Receptacles:	4 duplex per room and shall be tamper-resistant or equipped with ground-fault circuit interrupters (GFCI's)

Bathroom**Architectural:**

Floor Finish:	2" x 2" Ceramic Tile
Base:	2" x 2" Ceramic Tile
Wall Finish:	Gypsum Board (epoxy paint) with full height ceramic tile on backer board at shower,
Ceiling:	Gypsum Board (epoxy paint)
Ceiling Height:	9'-0" recommended, 8'-0" minimum
Noise (STC Rating):	STC 40 minimum, STC 45 recommended
Slab Depression:	3" recommended for slope to shower drain
Hardware:	VA Hardware Set #14
Doors:	3'-0" x 7'-0" wood.
Windows:	Not required.

HVAC:

Inside Design Condition:	Conditioned by make-up air from adjacent space
Min. Air Supply Air Change/Hr:	Not Applicable
Return Air:	Not Permitted
Exhaust Air:	Highest of 10 air changes/hr, 50 CFM, or room air balance.
Room Noise Level:	NC 35
Individual Temperature Control:	Not Required
Room Air Balance:	Double negative

Electrical:

Lighting Levels:	
Gen. Illumination:	30 fc
Task Illumination:	50 fc over lavatory
Night Illumination:	Low level lighting for wayfinding.
Emerg. Illumination:	Provide one source
Emergency Power:	Not Applicable
Receptacles:	2 GFCI

6.2 Bedroom, One Bed, Standard (BRUN1) - 100 NSF [9.3 NSM] Bathroom, Standard (TLTS2) - 50 NSF [4.7 NSM]

Equipment Table:

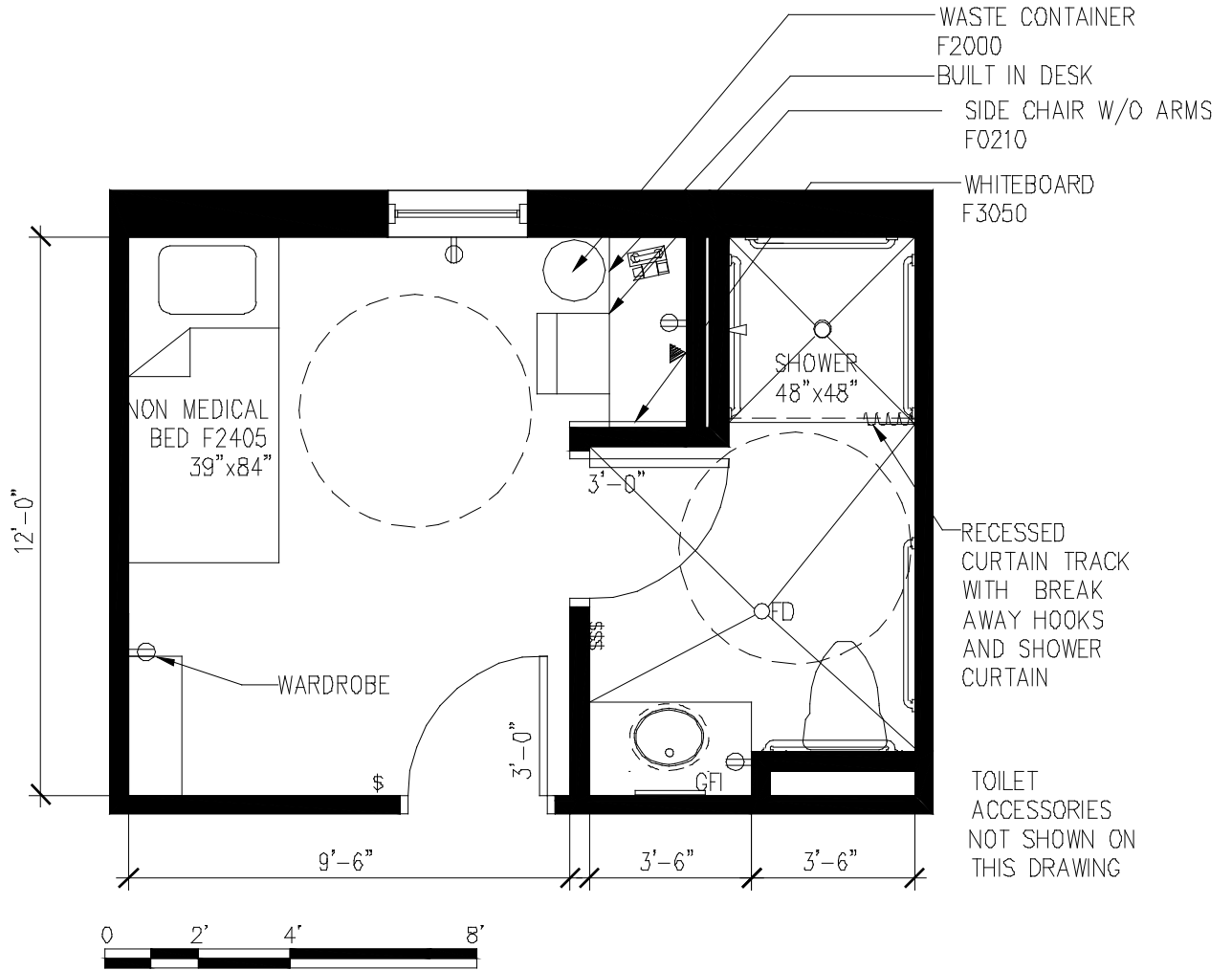
See Legend of Symbols in Section 1.6

SYMBOL	QUANTITY	AI	DESCRIPTION
			Note: Where VA standard items are shown, non-institutional & sustainable options should be considered if feasible.
JSN F2405	1	VV	BED, NON-MEDICAL SINGLE 1015mm x 2106mm x 457mm (40"w x 83"l x 18"h)
JSN F0210	1	VV	SIDE CHAIR, NON-TILTING, NO ARMS, UPHOLSTERED 812mm x 482mm x 584mm (32"h x 19"w x 23"d)
JSN A1010	1	CC	TELECOMMUNICATION OUTLET
JSN A1011	1	CC	TELEPHONE, DESK, 1 LINE
NO JSN	1	VV	DESK WITH 3 DRAWERS 761mm x 1066mm x 609mm (30" h x 42"w X 24"d)
NO JSN	1	VV	WARDROBE, WITH 4 DRAWERS 1371mm x 1218mm x 457mm (54" h x 48" w x 18"d)
JSN F2000	1	VV	WASTE CONTAINER, PLASTIC 457mm x 406mm dia. (18"h x 16" dia.)
JSN F3050	1	CC	MARKER BOARD, WHITE PORCELAIN 457mm x 609mm (18" h x 24" w)
JSN M0500	1	VV	TELEVISION, COLOR, 508mm diag. (20" diag.)
JSN M0505	1		TV BRACKETS FOR WALL MOUNT
BATHROOM (TLTS3):			
JSN A1085	1	CC	MIRROR, STAINLESS STEEL FRAME WITH PLEXIGLASS, 457mm x 914mm (36"h x 18"w)
JSN A5075	1	VV	DISPENSER, SOAP, DISPOSABLE
JSN UA5145	AR	CC	COLLAPSIBLE HOOK, CLOTHES
JSN U5170	1	CC	COLLAPSIBLE ROD, SHOWER CURTAIN, 1" dia., W/CURTAIN & HOOKS
JSN A5200	1	CC	TOILET TISSUE HOLDER
JSN F2000	1	VV	WASTE CONTAINER, PLASTIC 457mm x 406mm dia. (18"h x 16" dia.)
JSN P5040	1	CC	SHOWER HEAD
JSN P9050	1	CC	TOILET, WALL HUNG, SIPHON JET
NO JSN	1	CC	VANITY, WITH SOLID SURFACE COUNTER TOP, MOLDED SELF EDGE AND BACKSPLASH; INTEGRAL LAVATORY

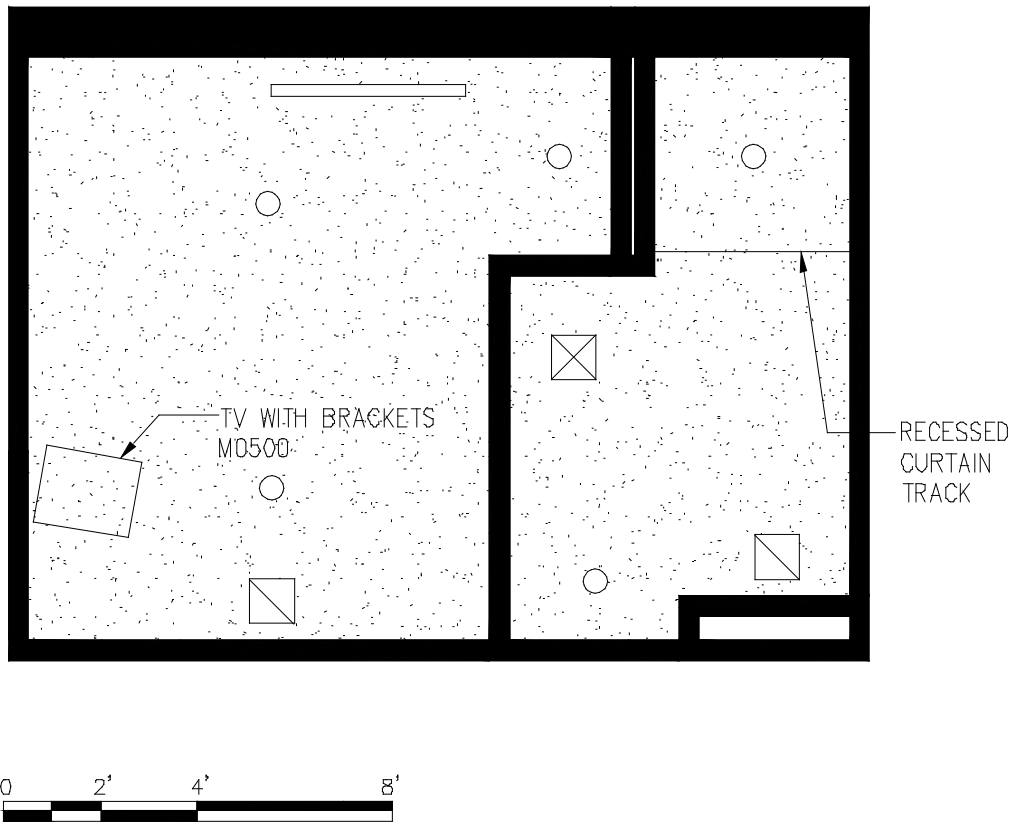
SYMBOL	QUANTITY	AI	DESCRIPTION
	1	CC	SHOWER: SOAP DISH, RECESSED

Table 6.2
Bedroom, One Bed, Standard/Bathroom, Standard

6.3 Bedroom, One Bed, Accessible (BRUN1) - 150 NSF [14.0 NSM]
 Bathroom, Accessible (TLTS2) - 65 NSF [6.1 NSM]
 Floor Plan



6.3 Bedroom, One Bed, Accessible (BRUN1) - 150 NSF [14.0 NSM]
Bathroom, Accessible (TLTS2) - 65 NSF [6.1 NSM]
Reflected Ceiling Plan



6.3 Bedroom, One Bed, Accessible (BRUN1) - 150 NSF [14.0 NSM] Bathroom, Accessible (TLTS2) - 65 NSF [6.1 NSM]

Function:

Single Occupancy Bedrooms comprise 70% of the bed space of a typical MH RRTP unit. 20% of these rooms should be accessible and/or accommodate bariatric residents up to 500 lbs. The patient bathroom contains an accessible sink, toilet and shower. All accessories are to be mounted for accessibility.

Note: Where VA standard items are shown, non-institutional & sustainable options should be considered if feasible.

Space Requirement:

Bedroom, Resident, One Bed, Accessible: 150 NSF [14.0 NSM]

Bathroom, Resident, Accessible: 65 NSF [6.1 NSM]

Bedroom

Architectural:

Floor Finish:	Sheet vinyl, linoleum or rubber flooring.
Base:	Rubber Base (Upgraded rubber base with molding profile recommended)
Wall Finish:	Gypsum Board, painted finish
Ceiling:	Gypsum Board, painted finish
Ceiling Height:	9'-0" preferred, 8'-0" minimum
Noise (STC Rating):	STC 40 minimum, STC 45 recommended
Hardware:	See Section 3 for general guidelines
Doors:	3'-10" x 7'-0" wood recommended. 3'-6" minimum width
Windows:	Required by code, see PG-18-3, Topic 1, Codes and Standards. Window unit shall have integral blinds for sun control located between layers of glazing. Inside layer shall be laminated glass. If operable, window unit must not open more than 4"

HVAC:

Inside Design Condition:	70 degrees F (21C) to 75 degrees F (24C) year round 30%- 50% Relative Humidity
Min. Air Supply Air Change/Hr:	6
Return Air:	Permitted
Exhaust Air:	Through connecting bathroom
Room Noise Level:	NC 35
Individual Temperature Control:	Required
Room Air Balance:	Positive with respect to bathroom, Neutral with respect to corridor.

Electrical:

Lighting Levels:	
Gen. Illumination:	5 fc
Task Illumination:	50 fc at bed and desk- may be provided by lamps furnished by others
Emerg. Illumination:	Provide one emergency light
Night Illumination:	Low level lighting for wayfinding to the bathroom.
Emergency Power:	Provide one source
Telecommunications:	One outlet
Receptacles:	4 duplex per room and shall be tamper-resistant or equipped with ground-fault circuit interrupters (GFCI's)

Bathroom**Architectural:**

Floor Finish:	2" x 2" Ceramic Tile
Base:	2" x 2" Ceramic Tile
Wall Finish:	Gypsum Board (epoxy paint) with full height ceramic tile on backer board at shower,
Ceiling:	Gypsum Board (epoxy paint)
Ceiling Height:	9'-0" recommended, 8'-0" minimum
Noise (STC Rating):	STC 40 minimum, STC 45 recommended
Slab Depression:	3" recommended for slope to shower drain
Hardware:	VA Hardware Set #14
Doors:	3'-6" x 7'-0" wood. 3'-0" minimum width
Windows:	Not required.

HVAC:

Inside Design Condition:	Conditioned by make-up air from adjacent space
Min. Air Supply Air Change/Hr:	Not Applicable
Return Air:	Not Permitted
Exhaust Air:	Highest of 10 air changes/hr, 50 CFM, or room air balance.
Room Noise Level:	NC 35
Individual Temperature Control:	Not Required
Room Air Balance:	Double negative

Electrical:

Lighting Levels:	
Gen. Illumination:	30 fc
Task Illumination:	50 fc over lavatory
Night Illumination:	Low level lighting for wayfinding.
Emerg. Illumination:	Provide one source
Emergency Power:	Not Applicable
Receptacles:	2 GFCI

6.3 Bedroom, One Bed, Accessible (BRUN1) - 150 NSF [14.0 NSM] Bathroom, Accessible (TLTS2) - 65 NSF [6.1 NSM]

Equipment Table:

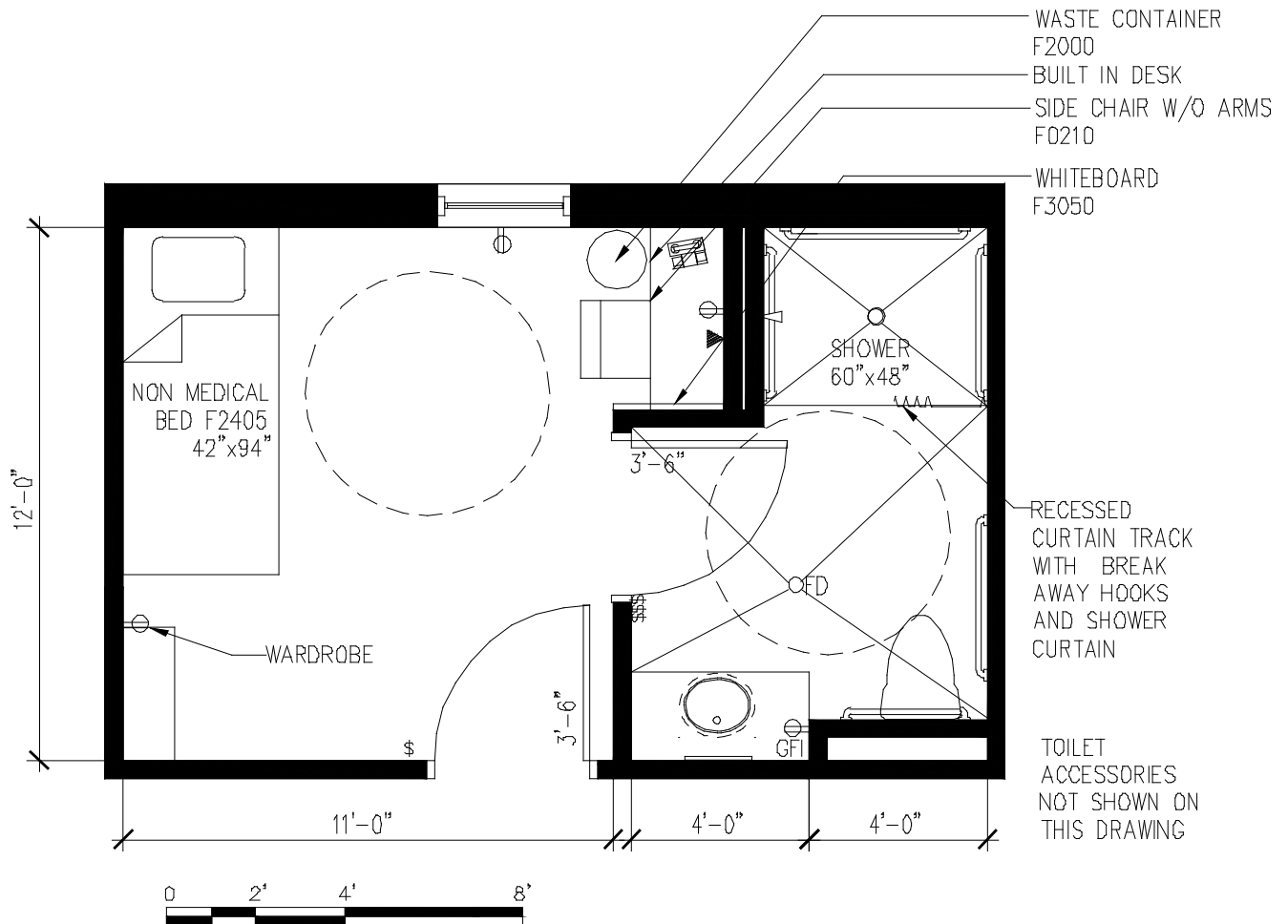
See Legend of Symbols in Section 1.6

SYMBOL	QUANTITY	AI	DESCRIPTION
			Note: Where VA standard items are shown, non-institutional & sustainable options should be considered if feasible.
JSN F2405	1	VV	BED, NON-MEDICAL SINGLE 1015mm x 2106mm x 457mm (40"w x 83"l x 18"h)
JSN F0210	1	VV	SIDE CHAIR, NON-TILTING, NO ARMS, UPHOLSTERED 812mm x 482mm x 584mm (32"h x 19"w x 23"d)
JSN A1010	1	CC	TELECOMMUNICATION OUTLET
JSN A1011	1	CC	TELEPHONE, DESK, 1 LINE
NO JSN	1	VV	DESK WITH 3 DRAWERS 761mm x 1066mm x 609mm (30" h x 42"w X 24"d)
NO JSN	1	VV	WARDROBE, WITH 4 DRAWERS 1371mm x 1218mm x 457mm (54" h x 48" w x 18"d)
JSN F2000	1	VV	WASTE CONTAINER, PLASTIC 457mm x 406mm dia. (18" h x 16" dia.)
JSN F3050	1	CC	MARKER BOARD, WHITE PORCELAIN 457mm x 609mm (18" h x 24" w)
JSN M0500	1	VV	TELEVISION, COLOR, 508mm diag. (20" diag.)
JSN M0505	1	CC	TV BRACKETS FOR WALL MOUNT
BATHROOM (TLTS3):			
JSN A1085	1	CC	MIRROR, STAINLESS STEEL FRAME WITH PLEXIGLASS, 457mm x 914mm (36"h x 18"w)
JSN A5075	1	VV	DISPENSER, SOAP, DISPOSABLE
JSN 5080	1	CC	DISPENSER, PAPER TOWEL, SURFACE MOUNTED, SATIN FINISH STAINLESS STEEL, SINGLE-FOLD,
JSN A5109	1	CC	GRAB BAR, 1-1/4" dia., STAINLESS STEEL, 2 WALL FOR WATER CLOSET
JSN A5110	1	CC	GRAB BAR, 1-1/4" dia., STAINLESS STEEL, SHOWER USE
JSN UA5145	AR	CC	COLLAPSIBLE HOOK, CLOTHES
JSN U5170	1	CC	COLLAPSIBLE ROD, SHOWER CURTAIN, 1" dia., W/CURTAIN & HOOKS
JSN A5200	1	CC	TOILET TISSUE HOLDER
JSN F2000	1	VV	WASTE CONTAINER, PLASTIC 457mm x 406mm dia. (18" h x 16" dia.)
JSN P5040	1	CC	SHOWER, SINGLE, HAND-HELD

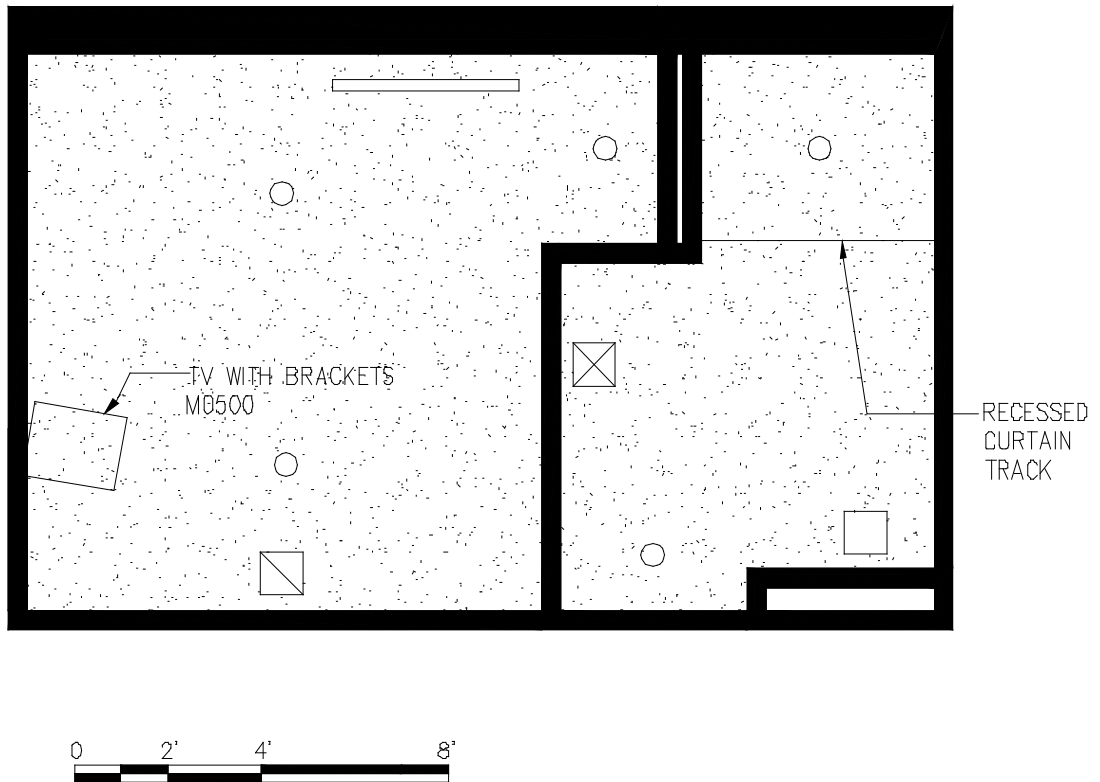
SYMBOL	QUANTITY	AI	DESCRIPTION
JSN P9050	1	CC	TOILET, WALL HUNG, SIPHON JET
	1	CC	VANITY, WITH SOLID SURFACE COUNTER TOP, MOLDED SELF EDGE AND BACKSPLASH; INTEGRAL LAVATORY
	1	CC	SHOWER: SOAP DISH, RECESSED

Table 6.3
Bedroom, One Bed/Bathroom, Accessible

6.4 Bedroom, One Bed, Bariatric (BRUN1) - 180 NSF [19.5 NSM]
 Bathroom, Bariatric (TLTS2) - 75 NSF [7.0 NSM]
 Floor Plan



6.4 Bedroom, One Bed, Bariatric (BRUN1) - 180 NSF [19.5 NSM]
Bathroom, Bariatric (TLTS2) - 75 NSF [7.0 NSM]
Reflected Ceiling Plan



6.4 Bedroom, One Bed, Bariatric (BRUN1) - 180 NSF [19.5 NSM] Bathroom, Bariatric (TLTS2) - 75 NSF [7.0 NSM]

Function:

Single Occupancy Bedrooms comprise 70% of the bed space of a typical MH RRTP unit. 20% of these rooms should be accessible and/or accommodate bariatric residents up to 500 lbs. The patient bathroom contains an accessible sink, toilet and shower. All accessories are to be mounted for accessibility.

Note: Where VA standard items are shown, non-institutional & sustainable options should be considered if feasible.

Space Requirement:

Bedroom, One Bed, Bariatric: 180 NSF [19.5 NSM]

Bathroom, Bariatric: 75 NSF [7.0 NSM]

Bedroom

Architectural:

Floor Finish:	Sheet vinyl, linoleum or rubber flooring.
Base:	Rubber Base (Upgraded rubber base with molding profile recommended)
Wall Finish:	Gypsum Board, painted finish
Ceiling:	Gypsum Board, painted finish
Ceiling Height:	9'-0" preferred, 8'-0" minimum
Noise (STC Rating):	STC 40 minimum, STC 45 recommended
Hardware:	See Section 3 for general guidelines
Doors:	3'-10" x 7'-0" wood recommended. 3'-6" minimum width
Windows:	Required by code, see PG-18-3, Topic 1, Codes and Standards. Window unit shall have integral blinds for sun control located between layers of glazing. Inside layer shall be laminated glass. If operable, window unit must not open more than 4"

HVAC:

Inside Design Condition:	70 degrees F (21C) to 75 degrees F (24C) year round 30%- 50% Relative Humidity
Min. Air Supply Air Change/Hr:	6
Return Air:	Permitted
Exhaust Air:	Through connecting bathroom
Room Noise Level:	NC 35
Individual Temperature Control:	Required
Room Air Balance:	Positive with respect to bathroom, Neutral with respect to corridor.

Electrical:

Lighting Levels:	
Gen. Illumination:	5 fc
Task Illumination:	50 fc at bed and desk- may be provided by lamps furnished by others
Emerg. Illumination:	Provide one emergency light
Night Illumination:	Low level lighting for wayfinding to the bathroom.
Emergency Power:	Provide one source
Telecommunications:	One outlet
Receptacles:	4 duplex per room and shall be tamper-resistant or equipped with ground-fault circuit interrupters (GFCI's)

Bathroom**Architectural:**

Floor Finish:	2" x 2" Ceramic Tile
Base:	2" x 2" Ceramic Tile
Wall Finish:	Gypsum Board (epoxy paint) with full height ceramic tile on backer board at shower,
Ceiling:	Gypsum Board (epoxy paint)
Ceiling Height:	9'-0" recommended, 8'-0" minimum
Noise (STC Rating):	STC 40 minimum, STC 45 recommended
Slab Depression:	3" recommended for slope to shower drain
Hardware:	VA Hardware Set #14
Doors:	3'-6" x 7'-0" wood. 3'-0" minimum width
Windows:	Not required.

HVAC:

Inside Design Condition:	Conditioned by make-up air from adjacent space
Min. Air Supply Air Change/Hr:	Not Applicable
Return Air:	Not Permitted
Exhaust Air:	Highest of 10 air changes/hr, 50 CFM, or room air balance.
Room Noise Level:	NC 35
Individual Temperature Control:	Not Required
Room Air Balance:	Double negative

Electrical:

Lighting Levels:	
Gen. Illumination:	30 fc
Task Illumination:	50 fc over lavatory
Night Illumination:	Low level lighting for wayfinding.
Emerg. Illumination:	Provide one source
Emergency Power:	Not Applicable
Receptacles:	2 GFCI

6.4 Bedroom, One Bed, Bariatric (BRUN1) - 180 NSF [19.5 NSM] Bathroom, Bariatric (TLTS2) - 75 NSF [7.0 NSM]

Equipment Table:

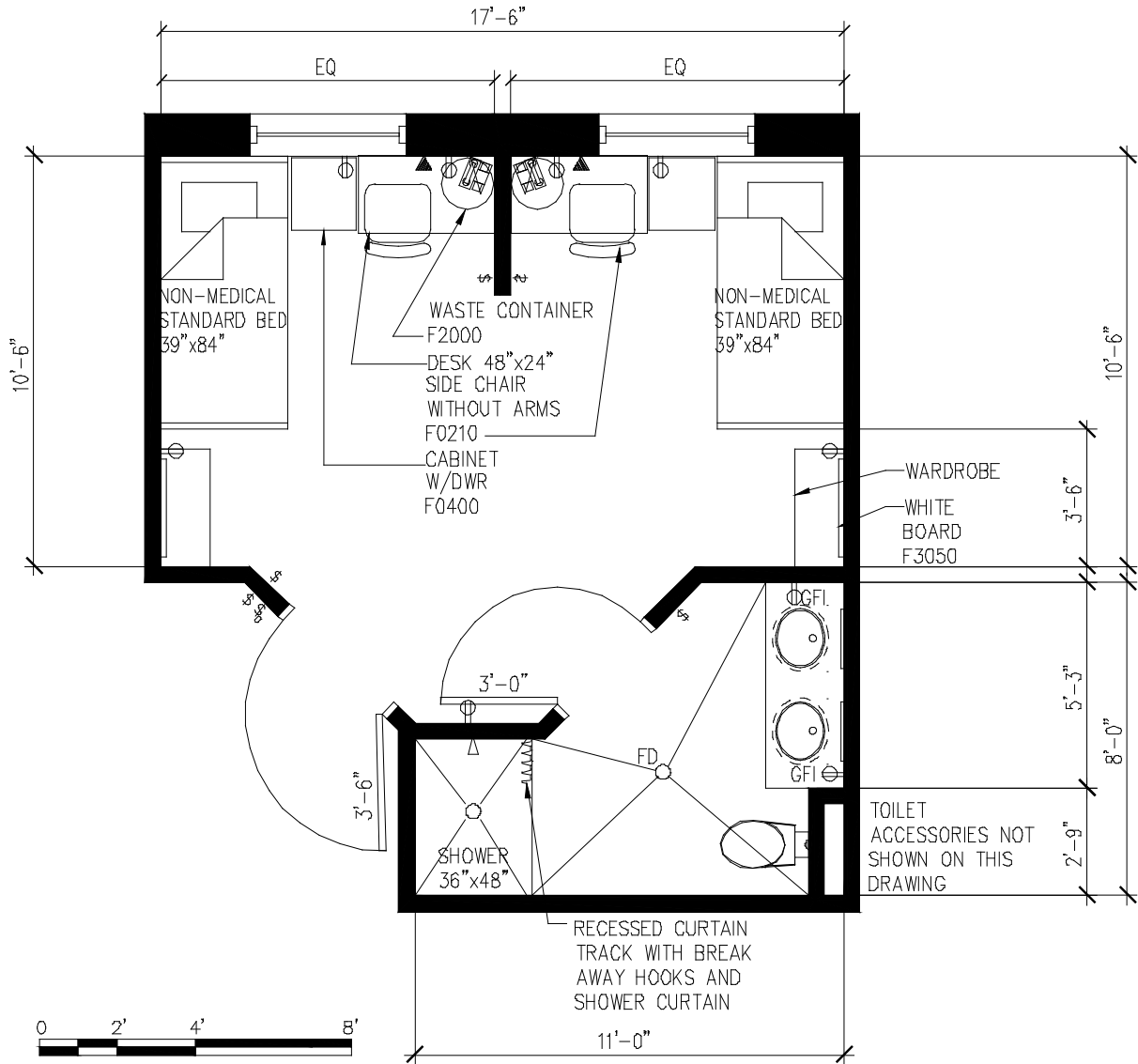
See Legend of Symbols in Section 1.6

SYMBOL	QUANTITY	AI	DESCRIPTION
			Note: Where VA standard items are shown, non-institutional & sustainable options should be considered if feasible.
JSN F2405	1	VV	BED, NON-MEDICAL BARIATRIC SINGLE 1066mm x 2386mm x 457mm (42"w x 94"l x 18"h)
JSN F0210	1	VV	SIDE CHAIR, NON-TILTING, NO ARMS, UPHOLSTERED 812mm x 660mm x 584mm (32"h x 26"w x 23"d)
JSN A1010	1	CC	TELECOMMUNICATION/DATA OUTLET
JSN A1011	1	CC	TELEPHONE, DESK, 1 LINE
NO JSN	1	VV	DESK WITH 3 DRAWERS 761mm x 1522mm x 609mm (30" h x 60" w X 24" d)
NO JSN	1	VV	WARDROBE, WITH 4 DRAWERS 1371mm x 1218mm x 457mm (54" h x 48" w x 18" d)
JSN F2000	1	VV	WASTE CONTAINER, PLASTIC 457mm x 406mm dia. (18" h x 16" dia.)
JSN F3050	1	CC	MARKER BOARD, WHITE PORCELAIN 457mm x 609mm (18" h x 24" w)
JSN M0500	1	VV	TELEVISION, COLOR, 508mm diag. (20" diag.)
JSN M0505	1	CC	TV BRACKETS FOR WALL MOUNT
BATHROOM (TLTS3):			
JSN A1085	1	CC	MIRROR, STAINLESS STEEL FRAME WITH PLEXIGLASS, 457mm x 914mm (36" h x 18" w)
JSN A5075	1	VV	DISPENSER, SOAP, DISPOSABLE
JSN 5080	1	CC	DISPENSER, PAPER TOWEL, SURFACE MOUNTED, SATIN FINISH STAINLESS STEEL, SINGLE-FOLD,
JSN A5109	1	CC	GRAB BAR, 1-1/4" dia., STAINLESS STEEL, 2 WALL FOR WATER CLOSET
JSN A5110	1	CC	GRAB BAR, 1-1/4" dia., STAINLESS STEEL, SHOWER USE
JSN UA5145	AR	CC	COLLAPSIBLE HOOK, CLOTHES
JSN U5170	1	CC	COLLAPSIBLE ROD, SHOWER CURTAIN, 1" DIAMETER, W/CURTAIN & HOOKS
JSN A5200	1	CC	TOILET TISSUE HOLDER
JSN F2000	1	VV	WASTE CONTAINER, PLASTIC 457mm x 406mm dia. (18" h x 16" dia.)
JSN P5040	1	CC	SHOWER, SINGLE, HAND-HELD

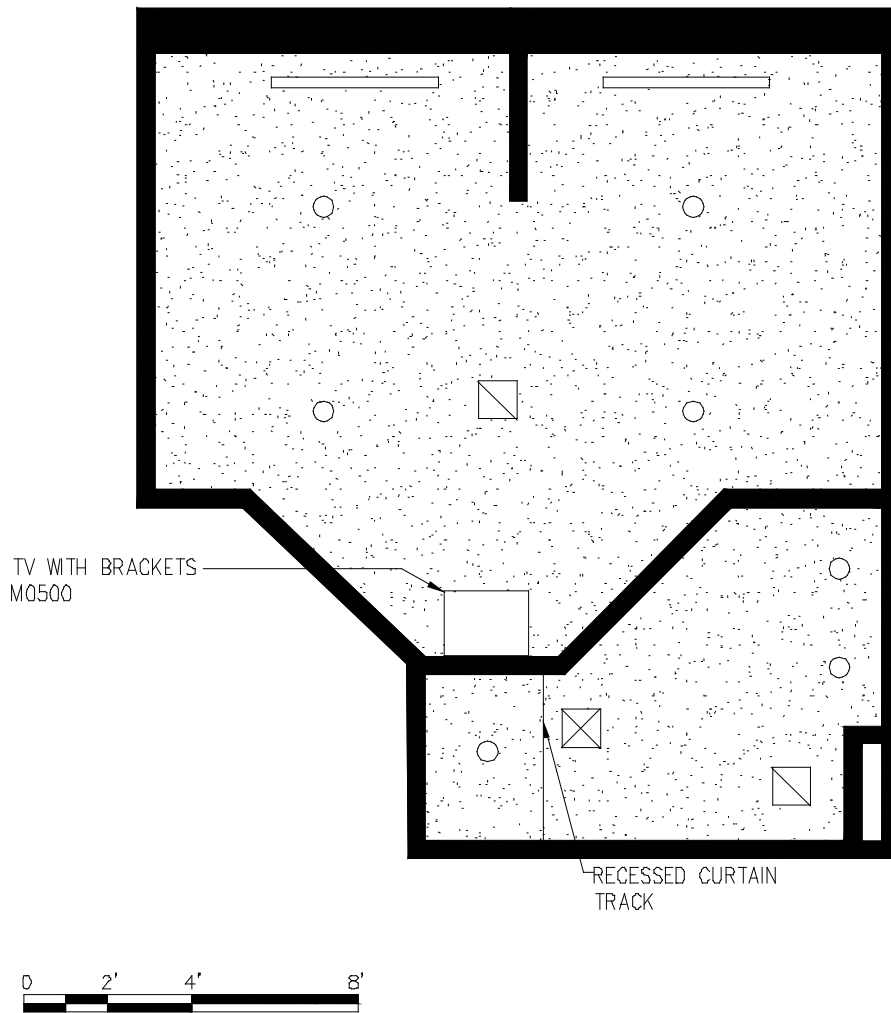
SYMBOL	QUANTITY	AI	DESCRIPTION
JSN P9050	1	CC	TOILET, WALL HUNG, SIPHON JET
	1	CC	VANITY, WITH SOLID SURFACE COUNTER TOP, MOLDED SELF EDGE AND BACKSPLASH; INTEGRAL LAVATORY OPTIONAL
	1	CC	SHOWER: SOAP DISH, RECESSED

Table 6.4
Bedroom, One Bed, Bariatric/Bathroom, Bariatric

6.5 Bedroom, Two Bed (BRNC2) - 200 NSF [18.6 NSM]
 Bathroom, Two Bed, Standard (TLTS2) - 75 NSF [7.0 NSM]
 Floor Plan



6.5 Bedroom, Two Bed (BRNC2) - 200 NSF [18.6 NSM]
Bathroom, Two Bed, Standard (TLTS2) - 75 NSF [7.0 NSM]
Reflected Ceiling Plan



6.5 Bedroom, Two Bed (BRNC2) - 200 NSF [18.6 NSM] Bathroom, Two Bed, Standard (TLTS2) - 75 NSF [7.0 NSM]

Function:

Double occupancy bedrooms comprise 15% of the total patient bedroom count (30% of the total bed count) in a typical domiciliary unit. These rooms are designed to accommodate the full range of resident classifications housed in this unit. .

Note: Where VA standard items are shown, non-institutional & sustainable options should be considered if feasible.

Space Requirement:

Bedroom, Resident, Two Bed, Standard: 200 NSF [18.6 NSM]

Bathroom, Resident, Standard: 60 NSF [5.7 NSM]

Bedroom

Architectural:

Floor Finish:	Sheet vinyl, linoleum or rubber flooring.
Base:	Rubber Base (Upgraded rubber base with molding profile recommended)
Wall Finish:	Gypsum Board, painted finish
Ceiling:	Gypsum Board, painted finish
Ceiling Height:	9'-0" preferred, 8'-0" minimum
Noise (STC Rating):	STC 40 minimum, STC 45 recommended
Hardware:	See Section 3 for general guidelines
Doors:	3'-10" x 7'-0" wood recommended. 3'-6" minimum width
Windows:	Required by code, see PG-18-3, Topic 1, Codes and Standards. Window unit shall have integral blinds for sun control located between layers of glazing. Inside layer shall be laminated glass. If operable, window unit must not open more than 4"

HVAC:

Inside Design Condition:	70 degrees F (21C) to 75 degrees F (24C) year round 30%- 50% Relative Humidity
Min. Air Supply Air Change/Hr:	6
Return Air:	Permitted
Exhaust Air:	Through connecting bathroom
Room Noise Level:	NC 35
Individual Temperature Control:	Required
Room Air Balance:	Positive with respect to bathroom, Neutral with respect to corridor.

Electrical:

Lighting Levels:	
Gen. Illumination:	5 fc
Task Illumination:	50 fc at bed and desk- may be provided by lamps furnished by others
Emerg. Illumination:	Provide one emergency light
Night Illumination:	Low level lighting for wayfinding to the bathroom.
Emergency Power:	Provide one source
Telecommunications:	One outlet
Receptacles:	4 duplex per room and shall be tamper-resistant or equipped with ground-fault circuit interrupters (GFCI's)

Bathroom**Architectural:**

Floor Finish:	2" x 2" Ceramic Tile
Base:	2" x 2" Ceramic Tile
Wall Finish:	Gypsum Board (epoxy paint) with full height ceramic tile on backer board at shower,
Ceiling:	Gypsum Board (epoxy paint)
Ceiling Height:	9'-0" recommended, 8'-0" minimum
Noise (STC Rating):	STC 40 minimum, STC 45 recommended
Slab Depression:	3" recommended for slope to shower drain
Hardware:	VA Hardware Set #14
Doors:	3'-6" x 7'-0" wood. 3'-0" minimum width
Windows:	Not required.

HVAC:

Inside Design Condition:	Conditioned by make-up air from adjacent space
Min. Air Supply Air Change/Hr:	Not Applicable
Return Air:	Not Permitted
Exhaust Air:	Highest of 10 air changes/hr, 50 CFM, or room air balance.
Room Noise Level:	NC 35
Individual Temperature Control:	Not Required
Room Air Balance:	Double negative

Electrical:

Lighting Levels:	
Gen. Illumination:	30 fc
Task Illumination:	50 fc over lavatory
Night Illumination:	Low level lighting for wayfinding.
Emerg. Illumination:	Provide one source
Emergency Power:	Not Applicable
Receptacles:	2 GFCI

6.5 Bedroom, Two Bed (BRNC2) - 200 NSF [18.6 NSM] Bathroom, Two Bed, Standard (TLTS2) - 75 NSF [7.0 NSM]

Equipment Table:

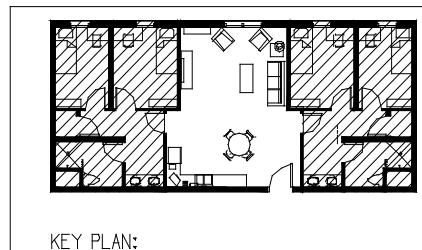
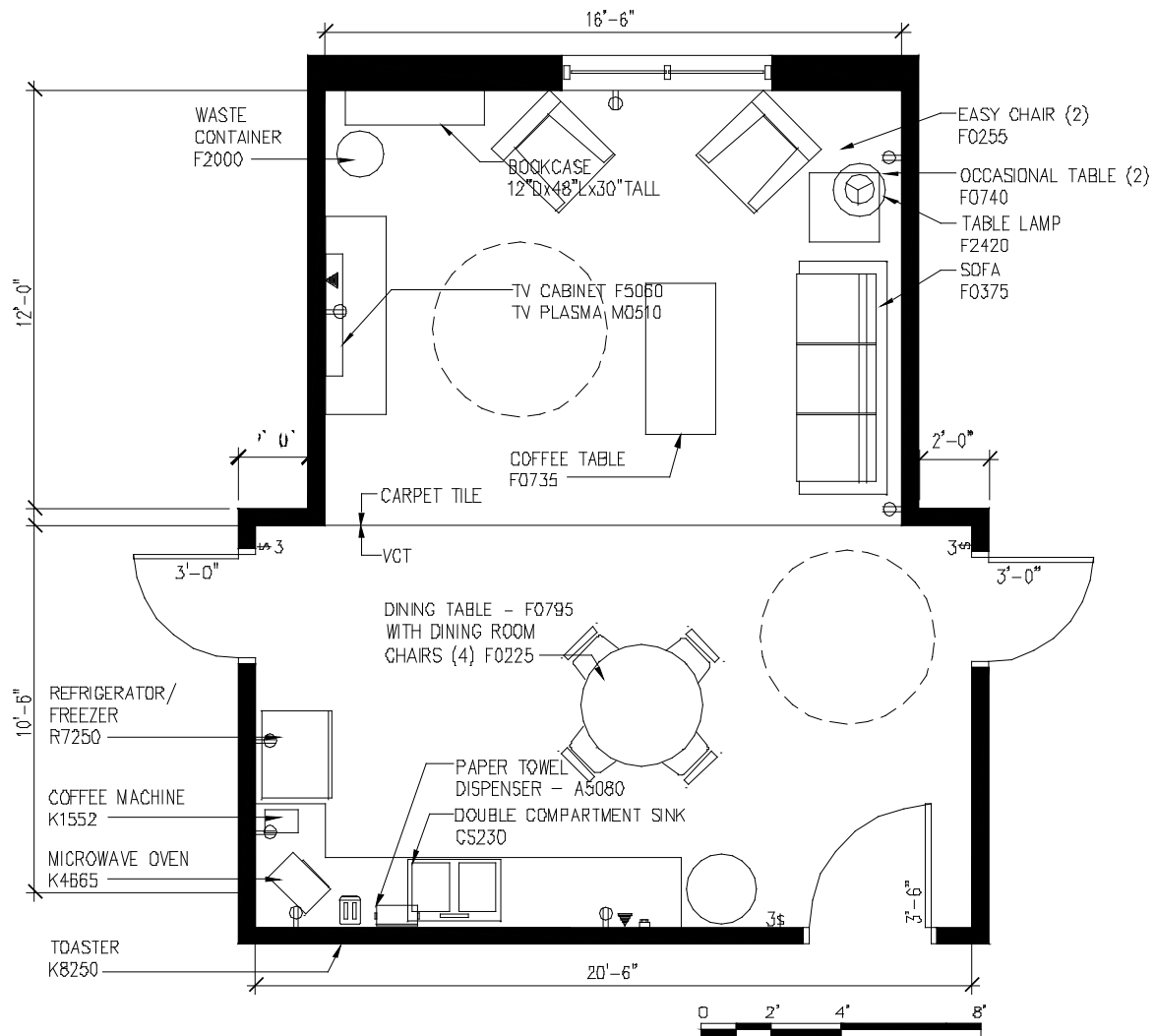
See Legend of Symbols in Section 1.6

SYMBOL	QUANTITY	AI	DESCRIPTION
			Note: Where VA standard items are shown, non-institutional & sustainable options should be considered if feasible.
JSN F2405	1	VV	BED, NON-MEDICAL SINGLE 1015mm x 2106mm x 457mm (40"w x 83"l x 18"h)
JSN F0210	1	VV	SIDE CHAIR, NON-TILTING, NO ARMS, UPHOLSTERED 812mm x 482mm x 584mm (32"h x 19"w x 23"d)
JSN A1010	1	CC	TELECOMMUNICATION OUTLET
JSN A1011	1	CC	TELEPHONE, DESK, 1 LINE
NO JSN	1	VV	DESK WITH 3 DRAWERS 761mm x 1066mm x 609mm (30" h x 42"w X 24"d)
NO JSN	1	VV	WARDROBE, WITH 4 DRAWERS 1371mm x 1218mm x 457mm (54" h x 48" w x 18"d)
JSN F2000	1	VV	WASTE CONTAINER, PLASTIC 457mm x 406mm dia. (18"h x 16" dia.)
JSN F3050	1	CC	MARKER BOARD, WHITE PORCELAIN 457mm x 609mm (18" h x 24" w)
JSN M0500	1	VV	TELEVISION, COLOR, 508mm diag. (20" diag.)
JSN M0505	1		TV BRACKETS FOR WALL MOUNT
BATHROOM, PATIENT (TLTS2):			
JSN A1085	1	CC	MIRROR, STAINLESS STEEL FRAME WITH PLEXIGLASS, 457mm x 914mm (36"h x 18"w)
JSN A5075	1	VV	DISPENSER, SOAP, DISPOSABLE
JSN UA5145	AR	CC	COLLAPSIBLE HOOK, CLOTHES
JSN U5170	1	CC	COLLAPSIBLE ROD, SHOWER CURTAIN, 1" dia., W/CURTAIN & HOOKS
JSN 5080	1	CC	DISPENSER, PAPER TOWEL, SURFACE MOUNTED, SATIN FINISH STAINLESS STEEL, SINGLE-FOLD,
JSN A5200	1	CC	TOILET TISSUE HOLDER
JSN F2000	1	VV	WASTE CONTAINER, PLASTIC 457mm x 406mm dia. (18"h x 16" dia.)
JSN P5040	1	CC	SHOWER, SINGLE, HAND-HELD
JSN P9050	AR	CC	TOILET, WALL HUNG, SIPHON JET
NO JSN	1	CC	VANITY, WITH SOLID SURFACE COUNTER TOP, MOLDED SELF EDGE AND BACKSPLASH; INTEGRAL LAVATORY

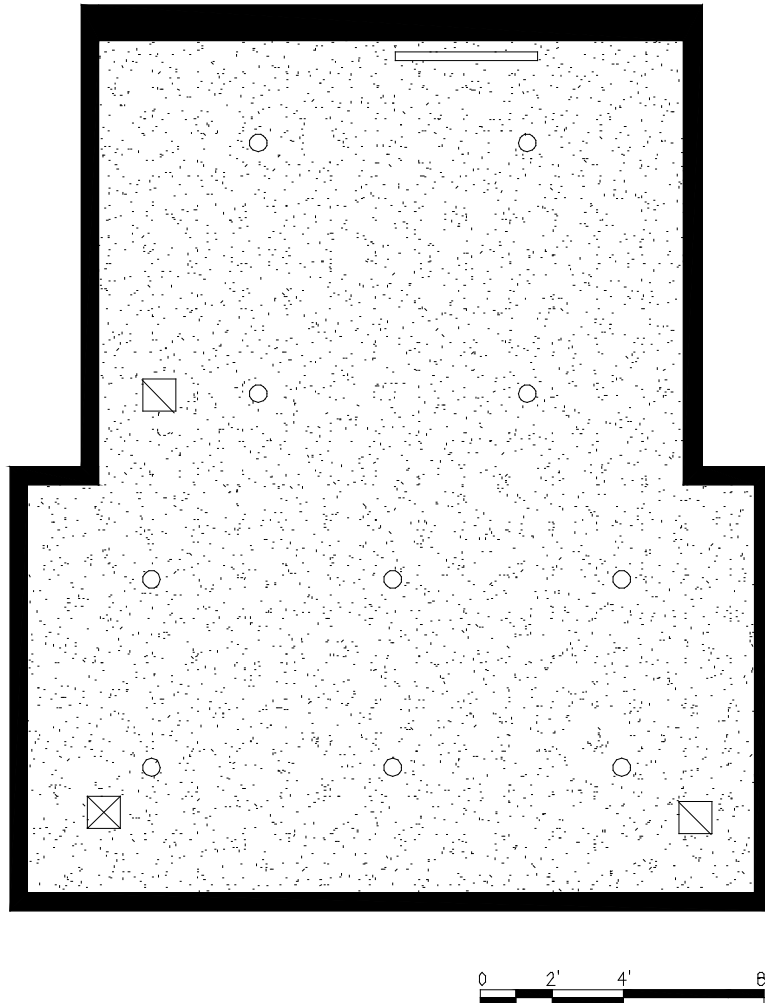
SYMBOL	QUANTITY	AI	DESCRIPTION
	1	CC	SHOWER: SOAP DISH, RECESSED

TABLE 6.5
Bedroom, Two Bed, Standard/Bathroom, Two Bed, Standard

6.6 Living Area (DAYR1) 150 NSF [13.9 NSM]
 Dining Area (FSCD1) 120 NSF [11.2 NSM]
 Kitchenette (IPK01) 90 NSF [8.4 NSM]
 Resident Living Storage (SRS01) 100 NSF [9.3 NSM]
 Floor Plan



- 6.6 Living Area (DAYR1) 150 NSF [13.9 NSM]
- Dining Area (FSCD1) 120 NSF [11.2 NSM]
- Kitchenette (IPK01) 90 NSF [8.4 NSM]
- Resident Living Storage (SRS01) 100 NSF [9.3 NSM]
- Reflected Ceiling Plan



- 6.6 Living Area (DAYR1) 150 NSF [13.9 NSM]
 Dining Area (FSCD1) 120 NSF [11.2 NSM]
 Kitchenette (IPK01) 90 NSF [8.4 NSM]
 Resident Living Storage (SRS01) 100 NSF [9.3 NSM]

Function:

Self-contained apartment for two to four residents.

Note: Where VA standard items are shown, non-institutional & sustainable options should be considered if feasible.

Space Requirement:

Living Area (DAYR1): 150 NSF [13.9 NSM]
 Dining Area (FSCD1): 120 NSF [11.2 NSM]
 Kitchenette (IPK01): 90 NSF [8.4 NSM]
 Residential Living Storage (SRS01): 100 NSF [9.3 NSM]

Architectural:

Floor Finish: Sheet vinyl, linoleum or rubber flooring
 Base: Rubber Base
 Wall Finish: Gypsum Board- Painted
 Ceiling: Gypsum Board
 Ceiling Height: 9'-0" recommended, 8'-0" minimum.
 Noise (STC Rating): STC 40
 Hardware: VA Hardware #10 (entry)
 Doors: 3'-6" x 7'-0" wood for entry 3'-0" minimum width
 3'-6" x 7'-0" wood for bedroom entry, 3'-0" minimum width
 Windows: Required by code, see PG-18-3, Topic 1, Codes and Standards.
 Window unit shall have integral blinds for sun control located
 between layers of glazing. Inside layer shall be laminated glass.
 If operable, window unit must not open more than 4"

HVAC:

Inside Design Condition: 70 degrees F (21C) to 75 degrees F (24C) year round
 30% -50% Relative Humidity
 Min. Air Supply Air Change/Hr: 6
 Return Air: Permitted
 Exhaust Air: At kitchenette
 Room Noise Level: NC 35
 Individual Temperature Control: Required
 Room Air Balance: Neutral.

Electrical:

Lighting Levels:
 Gen. Illumination: 30 fc
 Task Illumination: 50 fc at kitchenette.
 Emerg. Illumination: Provide one emergency light
 Night Illumination: Low level lighting for wayfinding to the corridor.
 Emergency Power: Provide one source
 Telecommunications: One outlet
 Receptacles: As required, receptacles shall be tamper-resistant or equipped
 with ground-fault circuit interrupters (GFCI's)

- 6.6 Living Area (DAYR1) 150 NSF [13.9 NSM]
 Dining Area (FSCD1) 120 NSF [11.2 NSM]
 Kitchenette (IPK01) 90 NSF [8.4 NSM]
 Resident Living Storage (SRS01) 100 NSF [9.3 NSM]

Equipment Table:

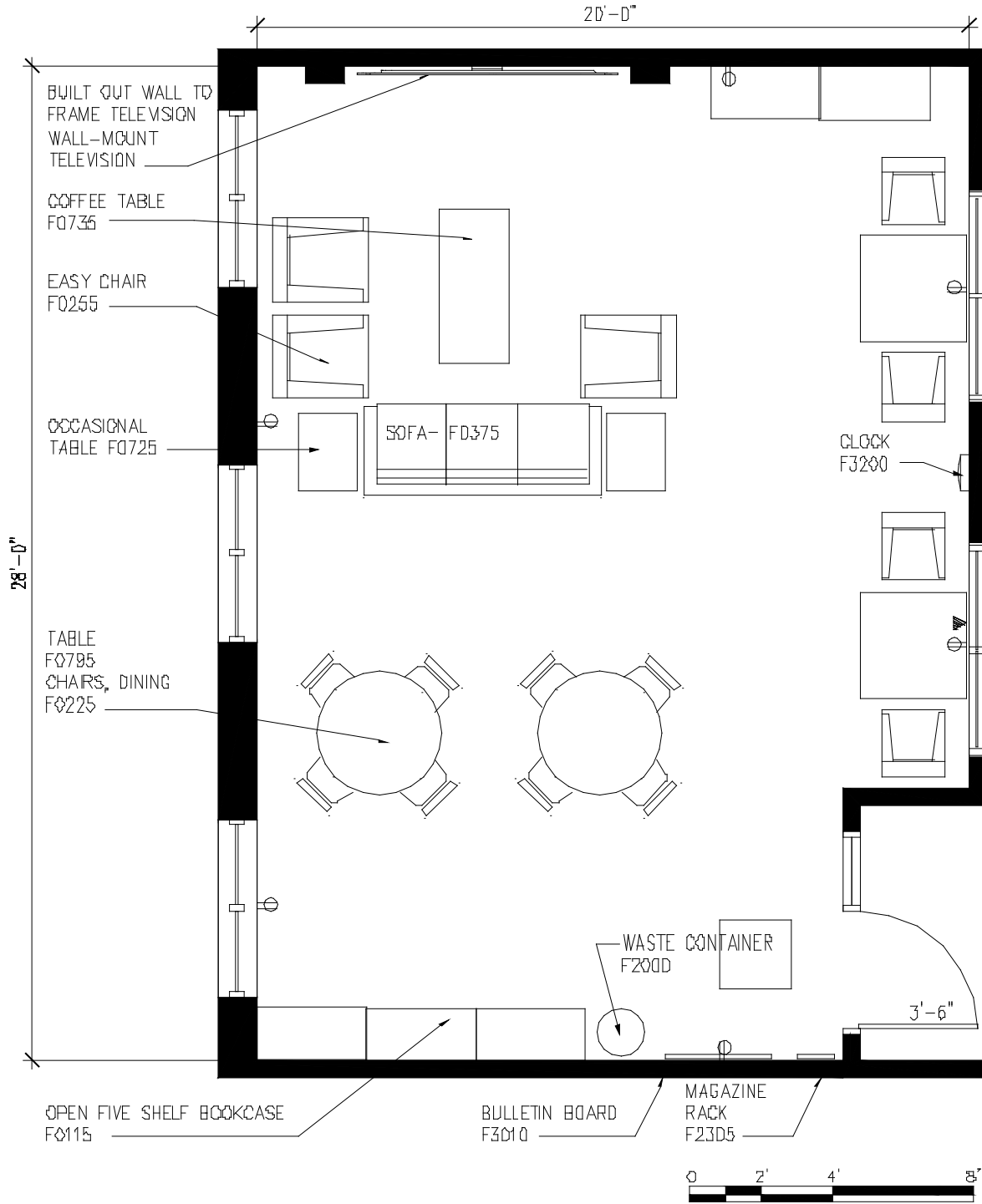
See Legend of Symbols in Section 1.6

SYMBOL	QUANTITY	AI	DESCRIPTION
			Note: Where VA standard items are shown, non-institutional & sustainable options should be considered if feasible.
LIVING/DINING/KITCHENETTE (IPK01)			
JSN A1010	AR	CC	TELECOMMUNICATION/DATA OUTLET
JSN A1012	1	CC	TELEPHONE, WALL MOUNTED, 1 LINE
JSN A5080	1	CC	DISPENSER, PAPER TOWERL, SURFACE MOUNTED, SATIN FINISH STAINLESS STEEL
JSN A5210	1	CC	BRACKET, TELEVISION, WALL MOUNTED, W/ADJUST ARM
JSN A5220	1	CC	BRACKET, TELEVISION, WALL BACKING
JSN A6046	AR	VV	ARTWORK, DECORATIVE, WITH FRAME (NOT SHOWN)
NO JSN	AR2	CC	KITCHEN CABINETRY BASE & UPPER AS REQ'D
JSN C05P0	1	CC	CABINET, SINK, U/C/B, 2 DOOR, 914mm x 1218mm 558mm (36"h x 48"l x 22"d)
JSN CS230	1	CC	SINK, STAINLESS STEEL, DOUBLE COMPARTMENT, 254mm x 355mm x406mm (10"d x 14"l x16"w)
NO JSN	2	CC	COUNTERTOP, SOLID SURFACE W/ 4" BACKSPLASH
		VV	LOW BOOKSHELF 305mm x 914mm x 761mm (12"w x 36"h x 30"h)
JSN F0225	AR	VV	CHAIR, DINING ROOM
JSN F0255	AR	VV	CHAIR, EASY WITH ARMS 888mm x 710mm x 812mm (35" h x 28"w x 32"d)
JSN F0795	AR	VV	TABLE, DINING ROUND 761mm x 1066mm (30"h x42" dia.)
JSN F2020	1	VV	CAN, TRASH, 44 gallon
JSN F0375	AR	VV	SOFA, UPHOLSTERED 862mm x 2157mm x 888mm (34"h x 85"w x 35"d)
JSN F0735	AR	VV	TABLE, COFFEE 457mm x 1320mm x 609mm (18"h x 52"w x 24"d)
JSN F0740	AR	VV	TABLE, OCCASIONAL, LAMP

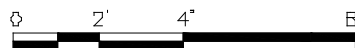
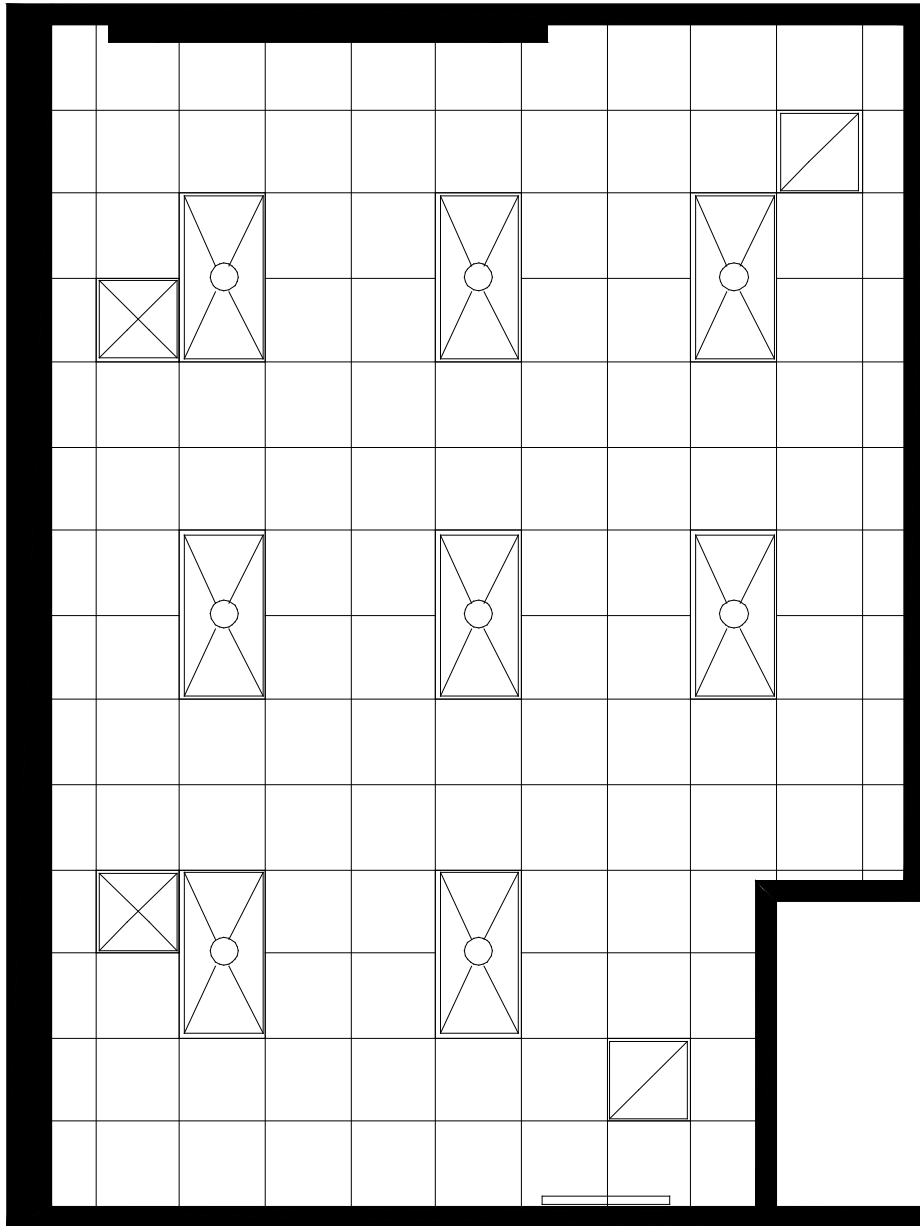
SYMBOL	QUANTITY	AI	DESCRIPTION
JSN F2000	AR	VV	WASTE CONTAINER, PLASTIC 457mm x 406mm dia. (18"h x 16" dia.)
JSN F2420	AR	VV	LAMP, TABLE, WITH SHADE
JSN F3200	1	VV	CLOCK, BATTERY, 305mm (12" dia.)
JSN K1552	1	VV	BREWER, COFFEE, AUTO, ELECT, 3 BURNER, FRONT/BACK
JSN K4665	1	VV	OVEN, MICROWAVE, CONSUMER
JSN K8250	1	VV	TOASTER, POP-UP, 4 SLICE, ELECTRIC
JSN M0510	1	VV	TV/VCR COMBINATION
JSN R7250	1	VV	REFRIGERATOR/FREEZER, 20 cu.ft.

TABLE 6.6
Resident Living Unit: Living/Dining/Kitchenette

6.7 Lounge, Resident (DAYR1) - 560 NSF [52.1 NSM] Floor Plan



6.7 Lounge, Resident (DAYR1) - 560 NSF [52.1 NSM] Reflected Ceiling Plan



6.7 Lounge, Resident (DAYR1) - 560 NSF [52.1 NSM]

Function:

A patient lounge is included within each MH RRTP facility. An additional 20 NSF per resident bed should be provided for each bed greater than 25.

Note: Where VA standard items are shown, non-institutional & sustainable options should be considered if feasible.

Space Requirement:

560 NSF [52.1 NSM]

Architectural:

Floor Finish:	Carpet, Carpet Tiles or resilient flooring is acceptable.
Base:	Rubber Base
Wall Finish:	Gypsum Board / Painted
Ceiling:	Acoustic Tile with clips or Gypsum Board with Acoustical Plaster
Ceiling Height:	9'-6" Min.
Noise (STC Rating):	Sound insulation from adjacent spaces critical. Provide STC 40 as a minimum and STC 45 for walls adjacent to resident rooms, group therapy rooms and conference rooms.
Hardware:	VA Hardware Set # 52
Doors:	3'-6" x 7'-0" wood with ½ light glazing if partitions are utilized.
Windows:	Exterior window units shall have integral blinds for sun control located between layers of glazing. Inside layer shall be laminated glass. If operable, window unit must not open more than 4". Interior glazing shall be laminated glass

Mechanical:

Inside Design Condition:	70 degrees F (21C) to 75 degrees F (24C) year round 30% -50% Relative Humidity
Min. Air Supply Air Change/Hr:	6
Return Air:	Permitted
Exhaust Air:	Not Required
Room Noise Level:	NC 40
Individual Temperature Control:	Required
Room Air Balance:	Neutral.

Electrical:

Lighting Levels:	
Gen. Illumination:	20 fc
Task Illumination:	30 fc at reading areas
Emerg. Illumination:	Provide one source
Emergency Power:	As required
Receptacles:	6 per room

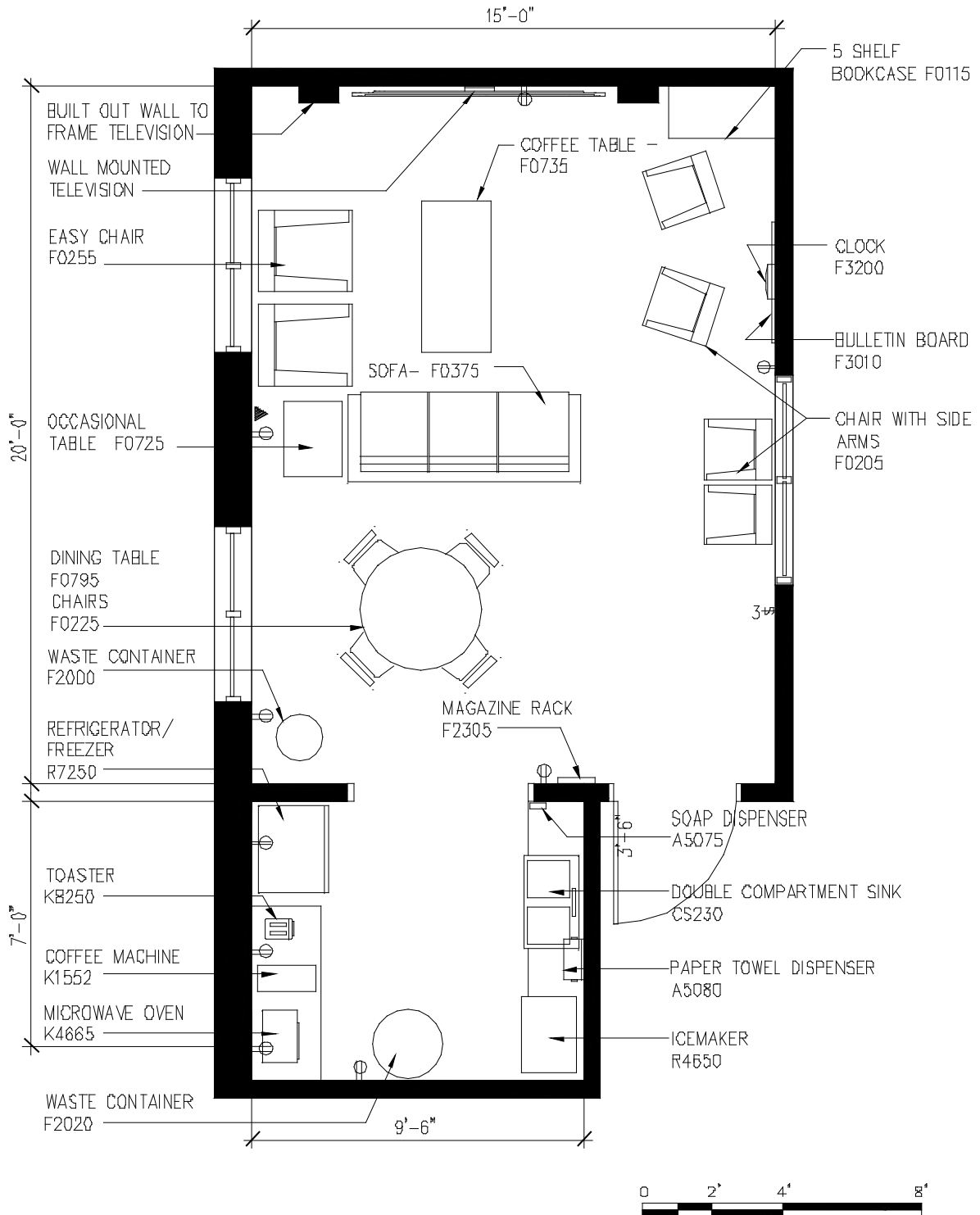
6.7 Lounge, Resident (DAYR1) - 560 NSF [52.1 NSM]

Equipment Table:

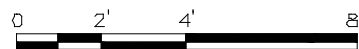
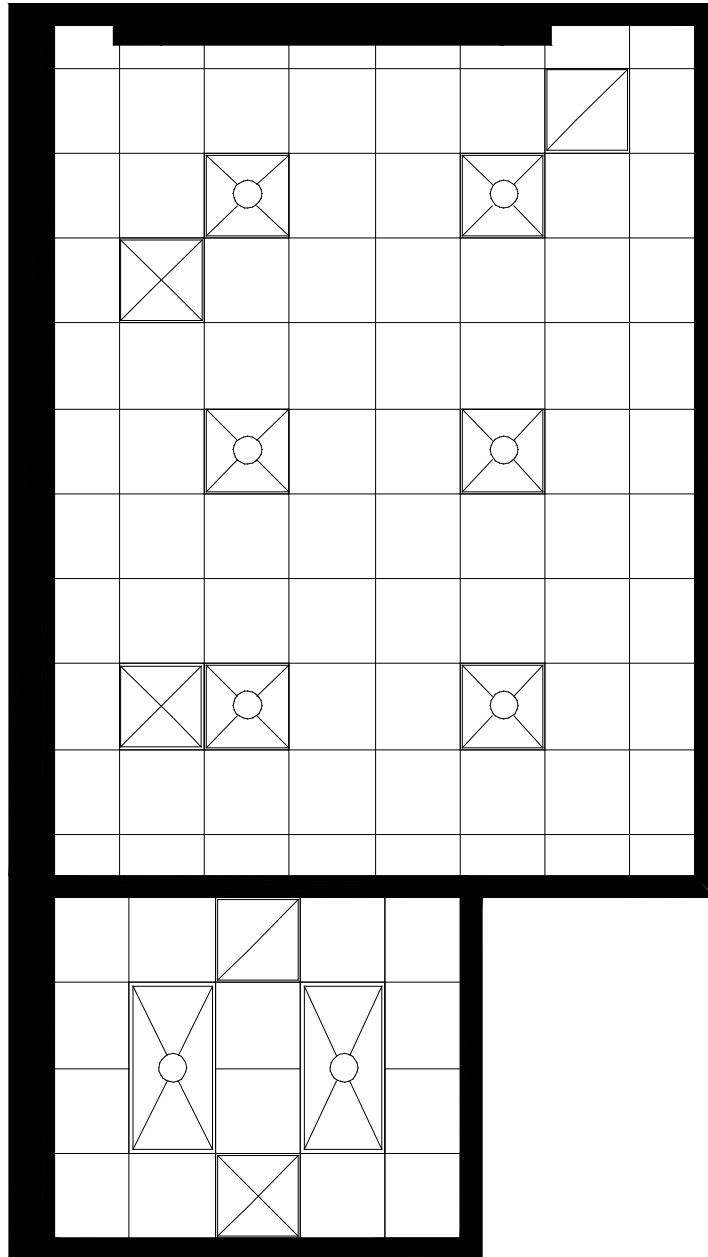
SYMBOL	QUANTITY	AI	DESCRIPTION
			<i>Note: Where VA standard items are shown, non-institutional & sustainable options should be considered if feasible.</i>
JSN A1010	1	CC	TELECOMMUNICATION/DATA OUTLET
NO JSN	1	CC	TV, PLASMA 32"H x 49"W x 12"D, WALL MOUNT
JSN A5220	1	CC	BRACKET, TELEVISION WALL BACKING
JSN A6046	AR	VV	ARTWORK (NOT SHOWN)
JSN F0115	AR	VV	BOOKCASE WITH FIVE (5) ADJUSTABLE SHELVES
JSN F0205	AR	VV	CHAIR, SIDE WITH ARMS
JSN F0210	AR	VV	CHAIR, SIDE, WITHOUT ARMS
JSN F0255	AR	VV	CHAIR, EASY WITH ARMS 888mm x 710mm x 812mm (35" h x 28"w x 32"d)
JSN F0225	AR	VV	CHAIR, DINING
JSN F0375	AR	VV	SOFA, UPHOLSTERED 862mm x 2157mm x 888mm (34"h x 85"w x 35"d)
JSN 0725	AR	VV	TABLE, OCCASIONAL
JSN F0735	AR	VV	TABLE, COFFEE 457mm x 1320mm x 609mm (18"h x 52"w x 24"d)
JSN F0795	AR	VV	TABLE, DINING ROUND 761mm x 1066mm (30"h x 42" dia.)
JSN F2000	1	VV	WASTE CONTAINER, PLASTIC 457mm x 406mm dia. (18"h x 16" dia.)
JSN F2305	1	VV	RACK, MAGAZINE, F/S
JSN F3010	1	CC	BOARD, BULLETIN, 1281mm x 1218mm (48"h x 48"w)
JSN F3200	1	VV	CLOCK, BATTERY OPERATED 305mm dia. (12" dia.)

TABLE 6.7
Lounge, Resident

6.8 Multi-Purpose Room / Kitchenette (IPK01) - 400 NSF [37.2 NSM] Floor Plan



6.8 Multi-Purpose Room / Kitchenette (IPK01) - 400 NSF [37.2 NSM] Reflected Ceiling Plan



6.8 Multi-Purpose Room / Kitchenette (IPK01) - 400 NSF [37.2 NSM]

Function: This space is available for residents as well as their families and visitors for special occasions. This space may also be used by residents to prepare and consume simple meals and snacks that don't require cooking and preparation in a residential type setting.

Note: Where VA standard items are shown, non-institutional & sustainable options should be considered if feasible.

Space Requirement:

Multi-Purpose Room / Kitchenette: 400 NSF [37.2 NSM]

Multi-Purpose Room

Architectural:

Floor Finish:	Sheet vinyl, linoleum or rubber flooring.
Base:	Rubber Base
Wall Finish:	Gypsum Board - Painted
Ceiling:	Acoustic Tile with clips or Gypsum Board with Acoustical Plaster
Ceiling Height:	9'-6" Min
Noise (STC Rating):	Sound insulation from adjacent spaces critical. Provide STC 40 as a minimum and STC 45 for walls adjacent to resident rooms, group therapy rooms and conference rooms.
Hardware:	VA Hardware Set # 52
Doors:	3'-6" x 7'-0" wood with ½ light glazing if partitions are utilized.
Windows:	Exterior window units shall have integral blinds for sun control located between layers of glazing. Inside layer shall be laminated glass. If operable, window unit must not open more than 4". Interior glazing shall be laminated glass

Mechanical:

Inside Design Condition:	70 degrees F (21C) to 75 degrees F (24C) year round 30% -50% Relative Humidity
Min. Air Supply Air Change/Hr:	6
Return Air:	Permitted
Exhaust Air:	Not Required
Room Noise Level:	NC 40
Individual Temperature Control:	Required
Room Air Balance:	Neutral.

Electrical:

Lighting Levels:	
Gen. Illumination:	30 fc
Task Illumination:	Not required
Emerg. Illumination:	Provide one source
Emergency Power:	As required
Receptacles:	As required

6.8 Multi-Purpose Room / Kitchenette (IPK01) - 400 NSF [37.2 NSM]

Kitchenette Space Requirement:

100 NSF [9.3 NSM]

Architectural:

Floor Finish:	Sheet vinyl, linoleum or rubber flooring.
Base:	Rubber Base
Wall Finish:	Gypsum Board - Painted
Ceiling:	Acoustic Tile with clips or Gypsum Board with Acoustical Plaster
Ceiling Height:	9'-6" Min
Noise (STC Rating):	Sound insulation from adjacent spaces critical. Provide STC 40 as a minimum and STC 45 for walls adjacent to resident rooms, group therapy rooms and conference rooms.

Mechanical:

Inside Design Condition:	Not applicable
Min. Air Supply Air Change/Hr:	6- Make up air of Minimum 50 CFM
Return Air:	Not Permitted
Exhaust Air:	100%
Room Noise Level:	NC 40
Individual Temperature Control:	Not Required
Room Air Balance:	Double negative

Electrical:

Lighting Levels:	
Gen. Illumination:	30 fc
Task Illumination:	50 fc
Emerg. Illumination:	As required
Emergency Power:	As required
Receptacles:	As required

6.8 Multi-Purpose Room / Kitchenette (IPK01) - 400 NSF [37.2 NSM]

Equipment Table:

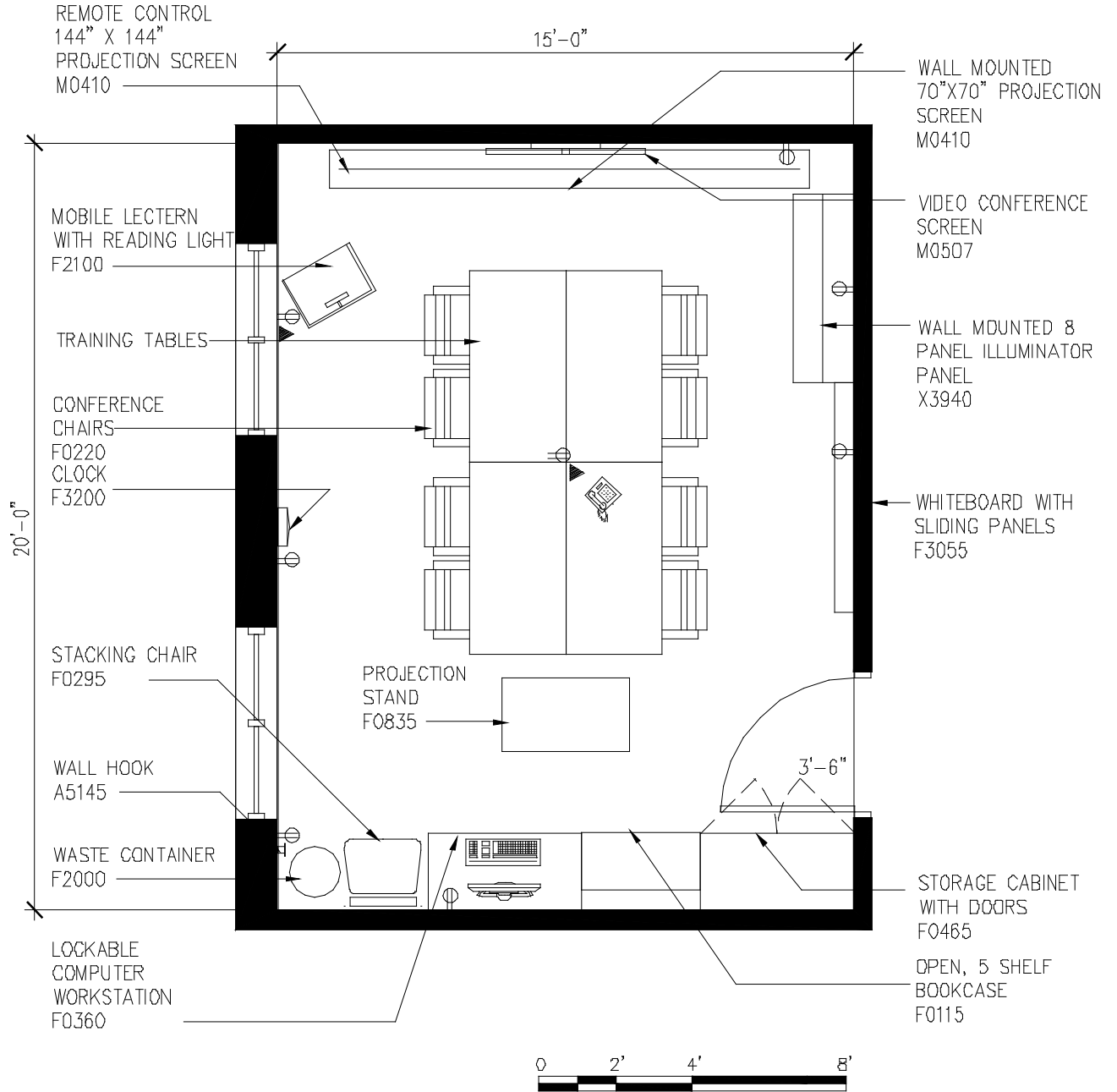
See Legend of Symbols in Section 1.6

SYMBOL	QUANTITY	AI	DESCRIPTION
			Note: Where VA standard items are shown, non-institutional & sustainable options should be considered if feasible.
JSN A1010	1	CC	TELECOMMUNICATION/DATA OUTLET
NO JSN	1	CC	TV, PLASMA, WALL MOUNT 812mm x 1243mm x 305mm (32"h x 49"w x 12"d)
JSN A5220	1	CC	BRACKET, TELEVISION WALL BACKING
JSN A6046	AR	VV	ARTWORK (NOT SHOWN)
JSN F0115	AR	VV	BOOKCASE WITH FIVE (5) ADJUSTABLE SHELVES
JSN F0205	AR	VV	CHAIR, SIDE WITH ARMS
JSN F0225	AR	VV	CHAIR, DINING ROOM
JSN F0255	AR	VV	CHAIR, EASY
JSN F0795	AR	VV	TABLE, DINING, 42"R OR 42"x42"
JSN F0375	AR	VV	SOFA, UPHOLSTERED
JSN F0725	AR	VV	TABLE, OCCASIONAL
JSN F0735	AR	VV	TABLE, COFFEE
JSN F2000	1	VV	WASTE CONTAINER, ROUND, METAL
JSN F2305	AR	VV	RACK, MAGAZINE, F/S
JSN F3010	1	CC	BOARD, BULLETIN, 48"x 48"
JSN F3200	1	VV	CLOCK, BATTERY OPERATED
KITCHENETTE			
JSN A5075	1	VV	DISPENSER, SOAP DISPOSABLE
JSN A5080	1	CC	DISPENSER, PAPER TOWELS , SURFACE MOUNTED
JSN F2020	1	VV	CAN, TRASH, 44 gal.
JSN K4665	1	VV	OVEN, MICROWAVE, CONSUMER
JSN C04J0		CC	UPPER AND LOWER CABINETS AS REQUIRED

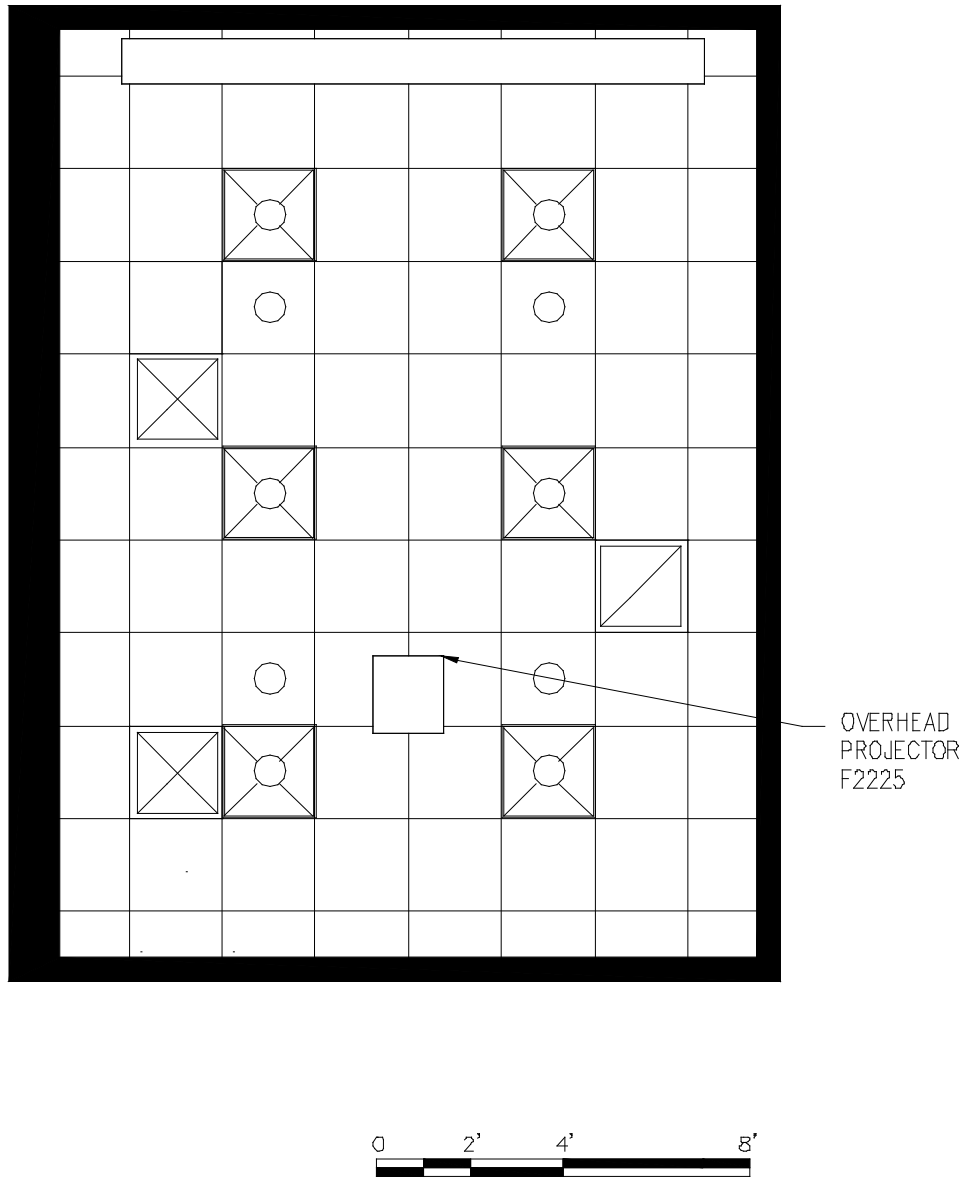
SYMBOL	QUANTITY	AI	DESCRIPTION
JSN C05P0	1	CC	CABINET, SINK, U/C/B, 2 DOOR, 914mm x1218mm x 558mm (36"h x 48"w x 22"d)
JSN CS230	1	CC	SINK, STAINLESS STEEL, DOUBLE COMPARTMENT, 10"d x 14"w x 13"l
JSN CT030	2	CC	COUNTERTOP, SOLID SURFACE
JSN K1552	1	VV	BREWER, COFFEE, AUTO,ELECTRIC, 3 BURNER, FRONT/BACK
JSN K8250	1	VV	TOASTER, POP-UP, 4 SLICE, ELECTRIC
JSN R4650	1	CC	ICEMAKER, FLAKED, WITH DISPENSER, 71"h x 19"w x 24"d
JSN R7250	1	VV	REFRIGERATOR/FREEZER, 20 CU FT

TABLE 6.8
Multi-Purpose / Kitchenette Room

6.9 Resident Education / Conference / Group Room (CRA02) - 300 NSF [27.9 NSM] Floor Plan



6.9 Resident Education / Conference / Group Room (CRA02) -
300 NSF [27.9 NSM]
Reflected Ceiling Plan



6.9 Resident Education / Conference / Group Room (CRA02) - 300 NSF [27.9 NSM]

Function: This space will be used for education programs as well as conferences or group therapy meetings on a scheduled basis. Audio-visual technology allows remote communication.

Note: Where VA standard items are shown, non-institutional & sustainable options should be considered if feasible.

Space Requirement:

Resident Education / Conference / group Room: 300 NSF [27.9 NSM]

Resident Education / Conference / Group Room

Architectural:

Floor Finish:	Sheet vinyl, linoleum or rubber flooring.
Base:	Rubber Base
Wall Finish:	Gypsum Board - Painted
Ceiling:	Acoustic Tile with clips or Gypsum Board with Acoustical Plaster
Ceiling Height:	9'-6" Min
Noise (STC Rating):	Sound insulation from adjacent spaces critical. Provide STC 40 as a minimum and STC 45 for walls adjacent to resident rooms, group therapy rooms and conference rooms.
Hardware:	VA Hardware Set # 40
Doors:	3'-6" x 7'-0" wood with ½ light glazing if partitions are utilized.
Windows:	Exterior window units shall have integral blinds for sun control located between layers of glazing. Inside layer shall be laminated glass. If operable, window unit must not open more than 4". Interior glazing shall be laminated glass.

Mechanical:

Inside Design Condition:	70 degrees F (21C) to 75 degrees F (24C) year round 30% -50% Relative Humidity
Min. Air Supply Air Change/Hr:	6
Return Air:	Permitted
Exhaust Air:	Not Required
Room Noise Level:	NC 35
Individual Temperature Control:	Required
Room Air Balance:	Neutral.

Electrical:

Lighting Levels:	
Gen. Illumination:	50 fc
Suppl. Illumination:	Dimmable Fluorescent down lights
Emerg. Illumination:	As required
Emergency Power:	As required
Receptacles:	As required

6.9 Resident Education / Conference / Group Room (CRA02) - 300 NSF [27.9 NSM]

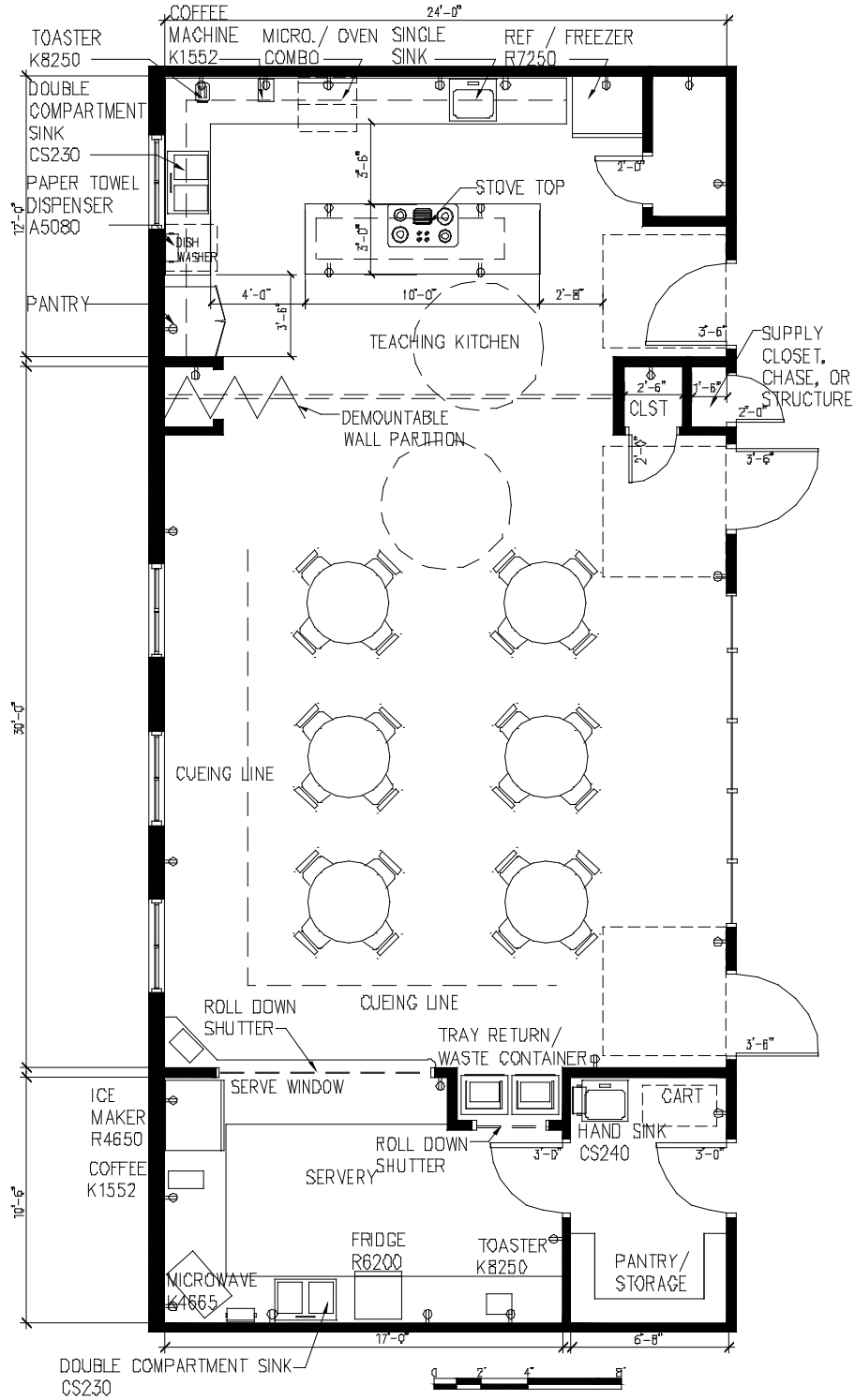
Equipment Table:

See Legend of Symbols in Section 1.6

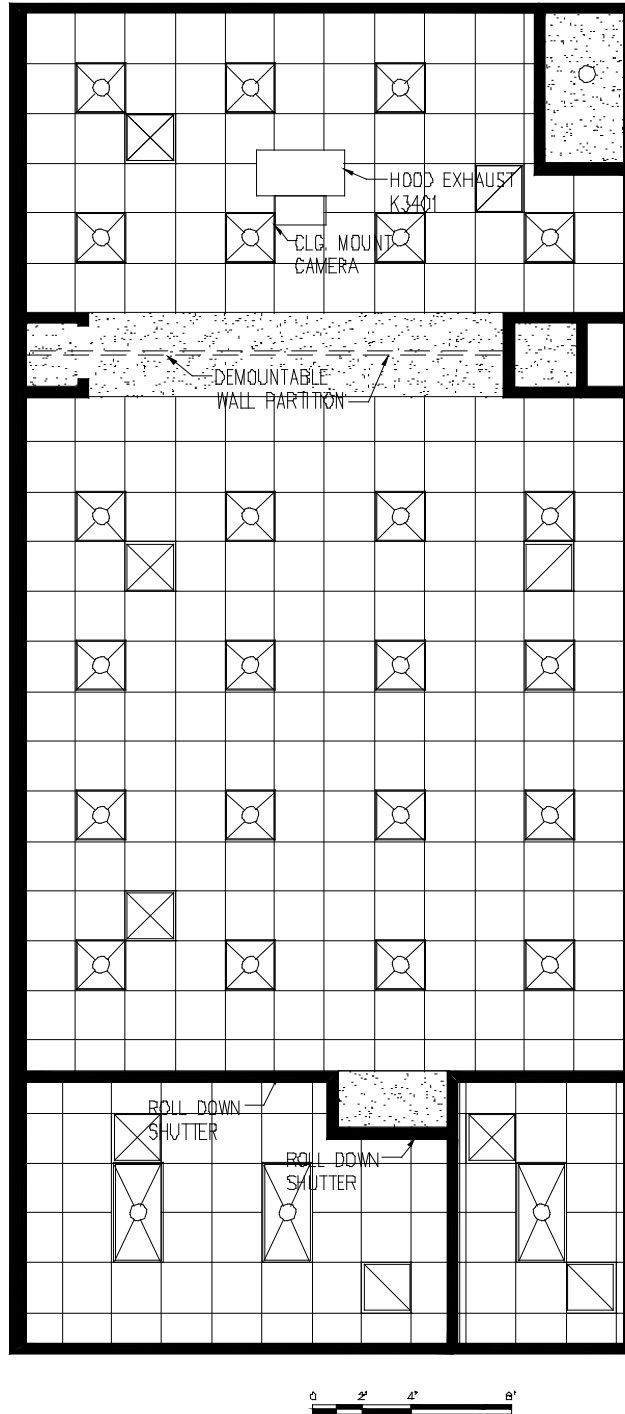
SYMBOL	QUANTITY	AI	DESCRIPTION
			Note: Where VA standard items are shown, non-institutional & sustainable options should be considered if feasible.
JSN A1010	2	CC	TELECOMMUNICATION OUTLET
JSN A1011	1	CC	TELEPHONE, 1 LINE
JSN A6046	1	VV	ARTWORK, DECORATIVE, WITH FRAME (NOT SHOWN)
JSN F0115	1	VV	BOOKCASE WITH FIVE (5) ADJUSTABLE SHELVES
JSN F0220	AR	VV	CHAIR, CONFERENCE
JSN F0295	AR	VV	CHAIR, STACKING
JSN F0465	1	VV	CABINET, STORAGE, 2 DOOR, 5 SHELVES
JSN F0360	1	VV	WORKSTATION, COMPUTER, ENCLOSED, WITH LOCK
JSN F0755	AR	VV	TABLES, CONFERENCE, WOOD
JSN F0835	1	VV	STAND, PROJECTION
JSN F2000	1	VV	WASTE CONTAINER, ROUND, METAL
JSN F2100	1	VV	LECTERN, MOBILE, WITH READING LIGHT
JSN F2225	1	VV	PROJECTOR, OVERHEAD
JSN F3055	1	VV	WHITE BOARD, WITH SLIDING PANELS
JSN F3200	1	VV	CLOCK, BATTERY OPERATED, 12" DIAMETER
JSN MO410	1	CC	SCREEN, PROJECTION, 70" x 70"
JSN M057	1	VV	VIDEO TELECONFERENCING SYSTEM
JSN M1801	1	VV	PC COMUTER WITH KEYBOARD

TABLE 6.9
Resident Education / Conference / Group Room

6.10 Dining Room (FSCD1) - 700 NSF [65 NSM]
Serving Line (FSPT1) - 235 NSF [21.8 NSM]
Training Kitchen (IPK01) - 290 NSF [26.9 NSM]
Floor Plan



6.10 Dining Room (FSCD1) - 700 NSF [65 NSM]
Serving Line (FSPT1) - 235 NSF [21.8 NSM]
Training Kitchen (IPK01) - 290 NSF [26.9 NSM]
Reflected Ceiling Plan



6.10 Dining Room (FSCD1) - 700 NSF [65 NSM] Serving Line (FSPT1) - 235 NSF [21.8 NSM] Training Kitchen (IPK01) - 290 NSF [26.9 NSM]

Function:

A patient dining area shall be included within each patient unit. The Dining Room should also be located near the entry to the patient unit so food service does not need to pass by patient rooms. A beverage station is located within the dining room which will have a roll down shutter to close the station during desired times. There shall be ample room to move patients around in wheelchairs and to assist bariatric patients. Separate entry and egress doors allow for a cueing line to the nourishment window and the tray return.

The Serving Line will consist of two parts: the Servery and the Pantry/Storage. The Servery shall be the area where patients are being served through a window which shall have a roll down shutter to secure the area. The Pantry/Storage area is for additional supplies, storage for a food service cart and a hand sink. This area can be co-located within the Servery area or have a dividing door.

Note: Where VA standard items are shown, non-institutional & sustainable options should be considered if feasible.

Space Requirement:

Dining Room: 700 NSF [65 NSM]
 Serving Line: 235 NSF [21.8 NSM]
 Training Kitchen: 290 NSF [26.9 NSM]

Dining Room

Architectural:

Floor Finish:	Sheet vinyl, linoleum or rubber flooring
Base:	Rubber Base
Wall Finish:	Gypsum Board
Ceiling:	Acoustic Tile with clips or gypsum board with acoustical plaster
Ceiling Height:	10'-8" preferred, 9'-6" minimum
Noise (STC Rating):	40.
Hardware:	VA Hardware #67 if applicable
Doors:	3'-6"x7'-0" if doors are used. Glazing shall be laminate glass. Metal Counter Shutter- size as required
Windows:	Laminate glazing on inside face of exterior windows and interior windows. Integral blinds recommended on exterior glazing for sun control.

HVAC:

Inside Design Conditions:	70 degrees F (21C), 75 degrees F (24C) 30%- 50% Relative Humidity
Min. Supply Air Change/ Hr.:	6
Return Air:	Permitted
Exhaust Air:	Not Required
Room Noise Level:	NC 40
Individual Temperature Control:	Required
Room Air Balance:	Neutral

Electrical:

Lighting Levels:

Gen. Illumination:	30 fc
Task Illumination:	Not Applicable
Emerg. Illumination:	As required

Telecommunications:	Two (one at each staff station)
Emergency Power:	Provide at staff station and for refrigerated equipment
Receptacles:	As required (including one at each staff station)

Serving/Pantry**Architectural:**

Floor Finish:	Slip resistant, easily cleanable surface such as quarry or porcelain tile.
Base:	To match flooring
Wall Finish:	Epoxy Painted Gypsum Board or other non-porous surface coating or material
Ceiling:	Acoustic Tile
Ceiling Height:	9'-0" minimum
Noise (STC Rating):	Not applicable.
Slab Depression:	Recommended based on flooring material.
Hardware:	VA Hardware #69
Doors:	3'-0"x7'-0" <ul style="list-style-type: none"> • Solid wood door with vision panel for use between Serving and Pantry • No vision panel for door to corridor
Windows:	Metal Counter shutter between Serving and Dining Not required.

HVAC:

Inside Design Conditions:	70 degrees F (21C), 75 degrees F (24C) 30%- 50% Relative Humidity
Min. Supply Air Change/ Hr.:	6
Return Air:	Permitted
Exhaust Air:	Not Required
Room Noise Level:	NC 40
Individual Temperature Control:	Required
Room Air Balance:	Neutral

Electrical:

Lighting Levels:

Gen. Illumination:	50 fc
Task Illumination:	N/A
Emerg. Illumination:	As required

Emergency Power:	As required
Receptacles:	As required per layout and equipment

Training Kitchen**Architectural:**

Floor Finish:	Sheet vinyl, linoleum or rubber flooring.
Base:	Rubber Base
Wall Finish:	Gypsum Board - Painted
Ceiling:	Acoustic Tile with clips or Gypsum Board with Acoustical Plaster

Ceiling Height: 9'-6" Min
Noise (STC Rating): Sound insulation from adjacent spaces critical. Provide STC 40 as a minimum and STC 45 for walls adjacent to resident rooms, group therapy rooms and conference rooms.

Mechanical:

Inside Design Condition: Not applicable
Min. Air Supply Air Change/Hr: 6- Make up air of Minimum 50 CFM
Return Air: Not Permitted
Exhaust Air: 100%
Room Noise Level: NC 40
Individual Temperature Control: Not Required
Room Air Balance: Double negative.

Electrical:

Lighting Levels:
 Gen. Illumination: 30 fc
 Task Illumination: 50 fc
 Emerg. Illumination: As required
Emergency Power: As required
Receptacles: As required

6.10 Dining Room (FSCD1) - 700 NSF [65 NSM]
 Serving Line (FSPT1) - 235 NSF [21.8 NSM]
 Training Kitchen (IPK01) - 290 NSF [26.9 NSM]

Equipment Table:

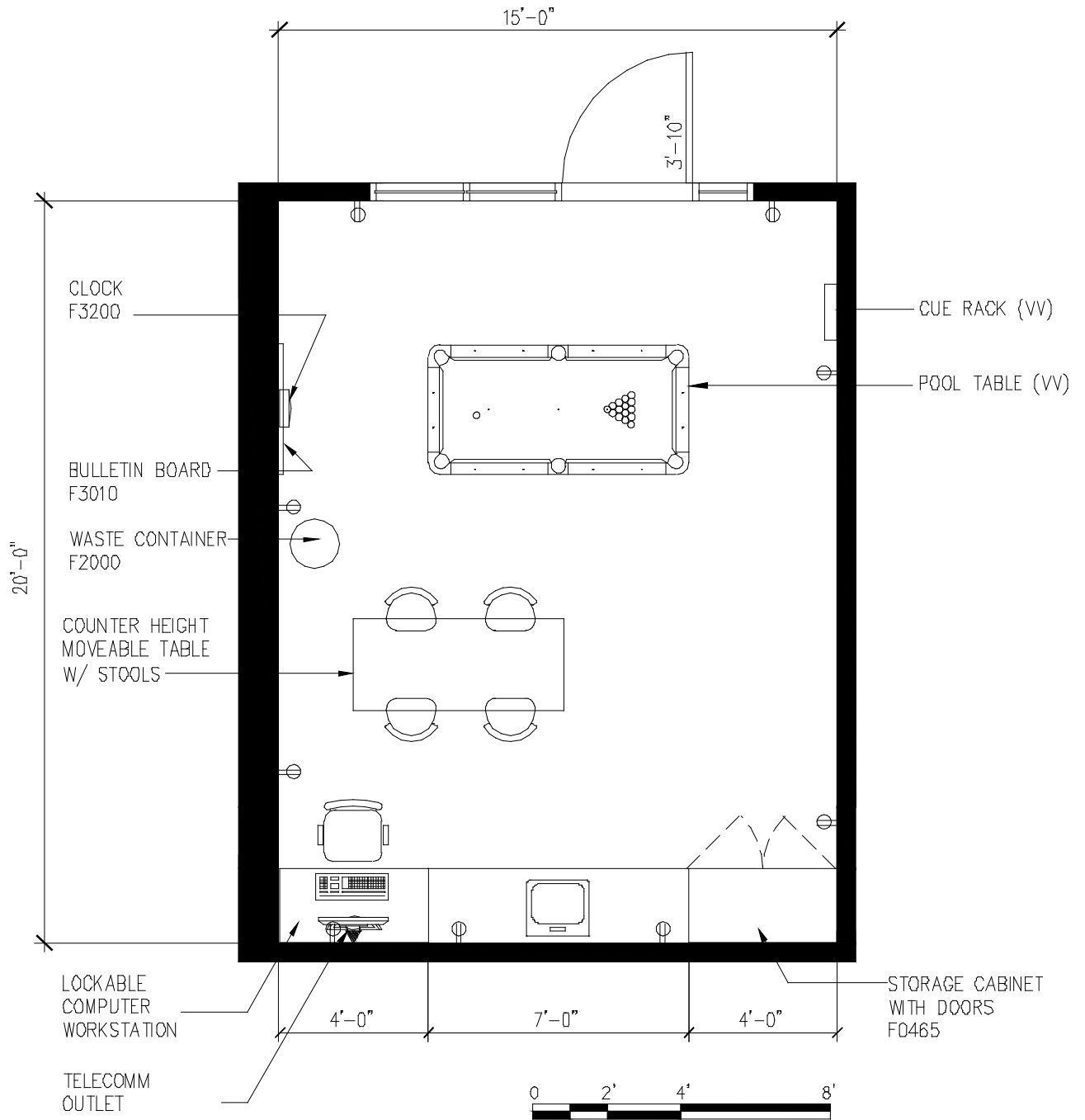
See Legend of Symbols in Section 1.6

SYMBOL	QUANTITY	AI	DESCRIPTION
			Note: Where VA standard items are shown, non-institutional & sustainable options should be considered if feasible.
JSN A1010	2	CC	TELECOMMUNICATION OUTLET.
JSN A1012	2	CC	TELEPHONE, WALL MOUNTED, 1 LINE
JSN F0225	AR	W	CHAIR, DINING, APPROX, 40" H X 19" W X 24" D
	AR	W	CHAIR, BARIATRIC, APPROX 50% OF TOTAL
JSN F0795	AR	VV	TABLE, (42" X42") ROUND
JSN A6046	AR	VV	ARTWORK, WALL MOUNTED, SECURELY FASTENED
F3200	1	VV	CLOCK, BATTERY, 12" DIAMETER
JSN R4650	1	CC	ICE MAKER, FLAKED, WITH DISPENSER, 71X19X24
			COUNTER FOR ICEMAKER WITH DRAWERS & CABINETS BELOW FOR STORAGE
SERVING LINE (FSPT1)			
JSN A5075	1	CC	DISPENSER, SOAP, DISPOSABLE
JSN A5080	1	CC	PAPER TOWEL DISPENSER, SATIN FINISH STAINLESS STEEL, SINGLE-FOLD, SURFACE MOUNTED
JSN CS230		CC	SINK, SS, DOUBLE COMPARTMENT, 10"X14"X16"
JSN C5240	1		SINK, SS, SINGLE COMPARTMENT, 12"X14"X16"
JSN R4650	1	CC	ICE MAKER, FLAKED, WITH DISPENSER, 71X19X24
	2		TRASH CAN HOUSING WITH TRAY RETURN ON TOP TO HOLD 32 GALLON TRASH CAN
JSN K1552	1	W	BREWER, COFFEE, AUTO, ELECT, 3 BURNER, FRONT/BACK
JSN R6200	1	W	UNDERCOUNTER REFRIGERATOR, LOCKABLE
JSN K4665	1	W	OVEN, MICROWAVE, CONSUMER
JSN K8250	1	W	TOASTER, POP-UP, 4 SLICE, ELECTRIC
		CC	BASE CABINETS-PLASTIC LAMINATE/COUNTER SOLID SURFACE
			FOOD DELIVERY CART
			12" DEEP MIN, ADJUSTABLE SHELVING FOR STORAGE IN PANTRY AREA

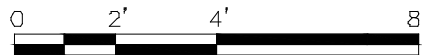
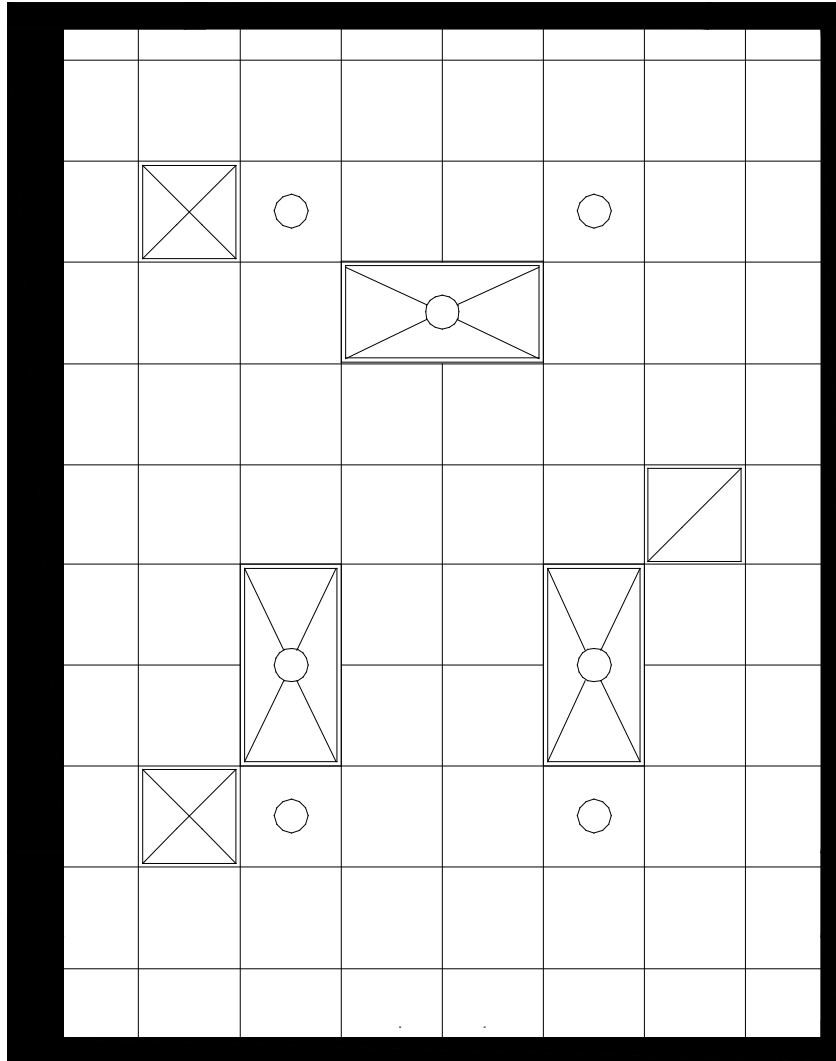
SYMBOL	QUANTITY	AI	DESCRIPTION
TRAINING KITCHEN (IPK01)			
JSN C5230			DOUBLE COMPARTMENT SINK
JSN A5080			PAPER TOWEL DISPENSER
JSN K1552			COFFEE MACHINE
			STOVE TOP, ELECTRIC
JSN K8250			TOASTER
JSN K7250			REFRIDGERATOR / FREEZER
			MICROWAVE / OVEN COMBINATION UNIT
			WASTER CONTAINER
			CABINETS, UNDER COUNTER & ABOVE AS NECESSARY
			SOLID SURFACE COUNTERTOP AS NECESSARY
			PROVIDE CABINET PANTRY 30" W X 84" TALL MIN
			DISHWASHER
			SOAP DISPENSER

TABLE 6.9
Dining Room / Serving Line / Training Kitchen

6.11 Recreation Therapy Room (DAYR1) - 300 NSF [27.9 NSM] Floor Plan



6.11 Recreation Therapy Room (DAYR1) - 300 NSF [27.9 NSM] Reflected Ceiling Plan



6.11 Recreation Therapy Room (DAYR1) - 300 NSF [27.9 NSM]

Function:

Provide an additional 6 NSF for each patient bed greater than 25 in a unit

Note: Where VA standard items are shown, non-institutional & sustainable options should be considered if feasible.

Space Requirement:

300 NSF [27.9 NSM]

Architectural:

Floor Finish:	Sheet vinyl, linoleum or rubber flooring.
Base:	Rubber Base
Wall Finish:	Gypsum Board - Painted
Ceiling:	Acoustic Tile with clips or Gypsum Board with Acoustical Plaster
Ceiling Height:	9'-6" Min
Noise (STC Rating):	Sound insulation from adjacent spaces critical. Provide STC 40 as a minimum and STC 45 for walls adjacent to resident rooms, group therapy rooms and conference rooms.
Hardware:	VA Hardware Set # 52
Doors:	3'-6" x 7'-0" wood with ½ light glazing if partitions are utilized.
Windows:	Exterior window units shall have integral blinds for sun control located between layers of glazing. Inside layer shall be laminated glass. If operable, window unit must not open more than 4". Interior glazing shall be laminated glass

Mechanical:

Inside Design Condition:	70 degrees F (21C) to 75 degrees F (24C) year round 30% -50% Relative Humidity
Min. Air Supply Air Change/Hr:	6
Return Air:	Permitted
Exhaust Air:	Not Required
Room Noise Level:	NC 40
Individual Temperature Control:	Required
Room Air Balance:	Neutral.

Electrical:

Lighting Levels:	
Gen. Illumination:	30 fc
Task Illumination:	Not required
Emerg. Illumination:	Provide one source
Emergency Power:	As required
Receptacles:	As required

6.11 Recreation Therapy Room (DAYR1) - 300 NSF [27.9 NSM]

Equipment Table:

SYMBOL	QUANTITY	AI	DESCRIPTION
			Note: Where VA standard items are shown, non-institutional & sustainable options should be considered if feasible.
JSN A1010	1	CC	TELECOMMUNICATION OUTLET
JSN A6046	AR	VV	ARTWORK, DECORATIVE, WITH FRAME
JSN F2000	1	VV	BASKET, WASTE PAPER, ROUND, METAL, 18" DIAMETER
JSN F3010	1	CC	BOARD, BULLETIN, 48"x 48"
JSN F3200	1	VV	CLOCK, BATTERY OPERATED, 12" DIAMETER
	1	VV	POOL TABLE 3'6"X7'-0" (SPACE LIMITATION)
	1	VV	CUE RACK WITH 48" CUE STICKS (SPACE LIMITATION)
	1	VV	FLOOR LAMP
	1		WORK TABLE COUNTER HEIGHT (5'-8"X2'-6")
	4		COUNTER HEIGHT STOOLS FOR WORK TABLE
JSN F0465	1		STORAGE CABINETS WITH DOORS
JSN F0360	1		LOCKABLE COMPUTER WORKSTATION
JSN M1801	1		PC COMPUTER STATION WITH KEYBOARD

TABLE 6.11
Recreation Therapy Room

(This page intentionally left blank)



Department of
Veterans Affairs



Office of Construction &
Facilities Management

Section 7

OUTPATIENT SERVICES

MENTAL HEALTH FACILITIES DESIGN GUIDE



7.0 Outpatient Services

General Note: Technical data included in these room templates reflects VA standards at the time this Design Guide was issued. Designers should refer to the latest VA technical documents for updated mechanical, electrical and other criteria that may be at a variance with the data listed in this Design Guide.

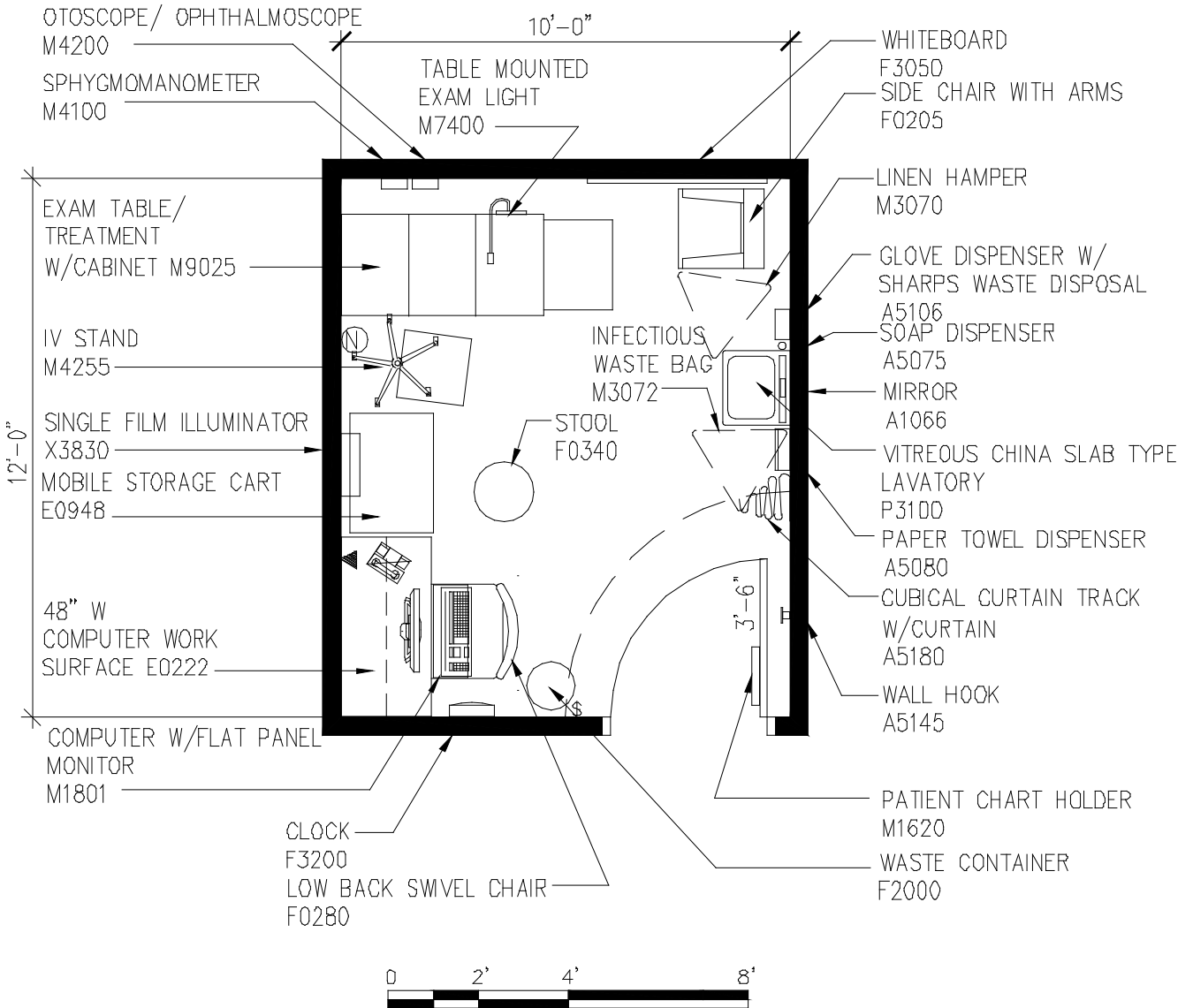
Design Guide Section 7

Design Guide Section No.	Room Name	Room Code	Current Space Criteria NSF [NSM]
7.1	Examination Room	EXRG3	120 NSF [11.2 NSM]
7.2	Treatment Room	TRGM1	180 NSF [17.0 NSM]
7.3	Group Therapy Room	OPMH1	300 NSF [27.9 NSM]
7.4	Group Testing Room	OPHM2	150 NSF [13.9 NSM]
7.5	Biofeedback Laboratory Treatment Room	OPHM3	150 NSF [13.9 NSM]
7.5	Biofeedback Laboratory Control Room/Office	CMP02	120 NSF [11.2 NSM]
7.6	Office, Counselor	OFD01	120 NSF [11.2 NSM]
7.7	Social Activities / Dining / Multi-Purpose Room	SL001	500 NSF [46.5 NSM]
7.8	Classroom / Group Room	CRA02	600 NSF [55.8 NSM]
7.9	Occupational Therapy	OTGC1	600 NSF [55.8 NSM]

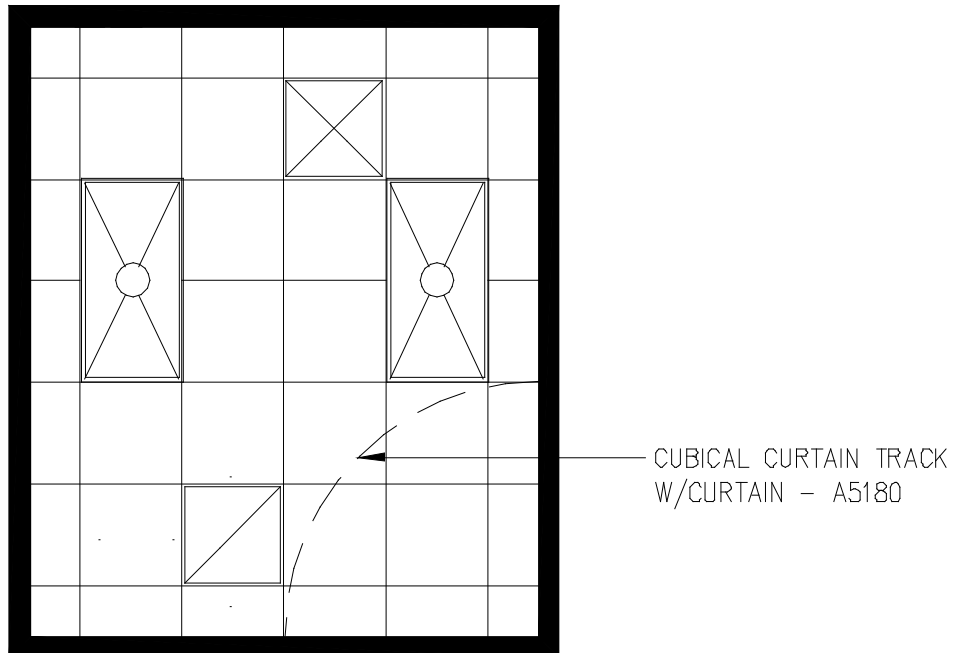
The chart below identifies which guide plate is used in a particular outpatient clinic or center:

	Room Name	Ref #	NSF	Psych. Services	Mental Health Clinic	Substance Abuse Clinic	PRRC
7.1	Exam Room	EXRG3	120	x	x		x
7.2	Treatment Room	TRGM1	180		x		x
7.3	Group Therapy/ Multipurpose	OPMH1	300	x	x	x	x
7.4	Group Testing	OPMH2	150	x			
7.5	Biofeedback Lab Treatment/ Control	OPMH3/ CMP02	150/120	x	x		x
7.6	Office	OFDC1/ OFDO1	120	x	x	x	x
7.7	Social Activities/Dining	SL001	500				x
7.8	Classroom	CRA02	600				x
7.9	Occupational Therapy	OTGC1	600				x

7.1 Examination Room (EXRG3) - 120 NSF [11.2 NSM] Floor Plan



7.1 Examination Room (EXRG3) - 120 NSF [11.2 NSM] Reflected Ceiling Plan



7.1 Examination Room (EXRG3) - 120 NSF [11.2 NSM]

Function:

The patient examination room will be used in both inpatient and outpatient settings for physical examinations, monitoring and assessments related to a mental health patient treatment plan. Individual consultation with mental health professionals will typically take place in their respective offices. Because of the safety threats posed by some of the equipment and supplies located in this room, patients should not be left unattended in this room at any time.

Note: Where VA standard items are shown, non-institutional & sustainable options should be considered if feasible.

Space Requirement:

120 NSF [11.2 NSM]

Architectural:

Floor Finish:	Sheet vinyl, linoleum or rubber flooring.
Base:	Rubber Base
Wall Finish:	Gypsum Board, painted finish
Ceiling:	Acoustic Tile
Ceiling Height:	9'-0" minimum
Noise (STC Rating):	STC 40 minimum, STC 45 recommended
Hardware:	VA Hardware #52
Doors:	3'-6" x 7'-0" wood.
Windows:	Not required. If provided, inside face of glazing shall be laminated glass.

HVAC:

Inside Design Condition:	70 degrees F (21C) to 75 degrees F (24C) year round 30% - 50% Relative Humidity
Min. Air Supply Air Change/Hr:	6
Return Air:	Permitted
Exhaust Air:	Not Required
Room Noise Level:	NC 35
Individual Temperature Control:	Required
Room Air Balance:	Neutral

Electrical:

Lighting Levels:	
Gen. Illumination:	50 fc
Task Illumination:	Provided by portable exam light
Emerg. Illumination:	Provide one emergency light
Emergency Power:	Provide one source
Telecommunications:	As required
Receptacles:	As required

7.1 Examination Room (EXRG3) - 120 NSF [11.2 NSM]

Equipment Table:

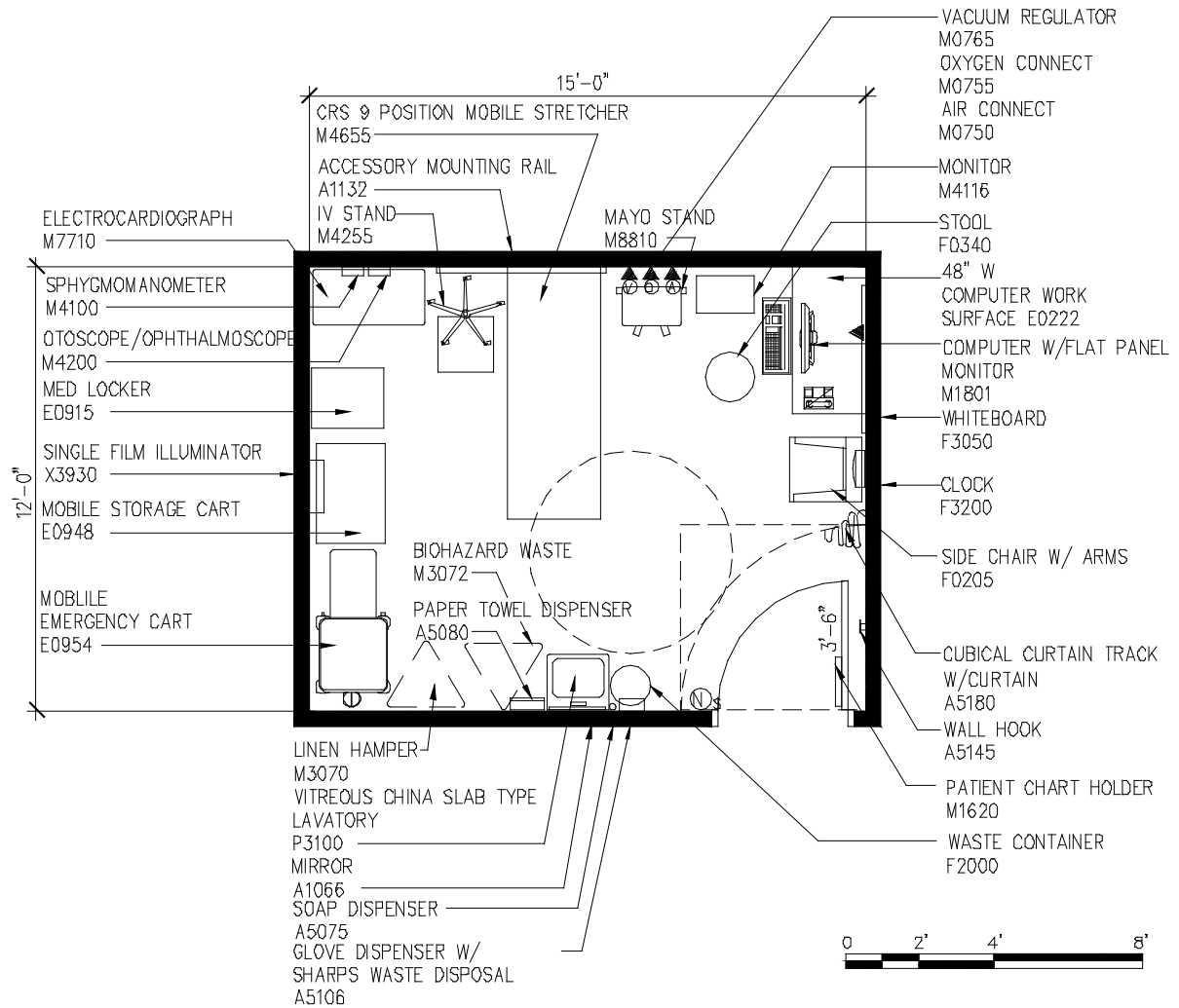
See Legend of Symbols in Section 1.6

SYMBOL	QUANTITY	AI	DESCRIPTION
			Note: Where VA standard items are shown, non-institutional & sustainable options should be considered if feasible.
JSN A1010	1	CC	TELECOMMUNICATION/DATA OUTLET
JSN A1012	1	CC	TELEPHONE, DESK, WITH SPEAKER
JSN A1066	1	VV	MIRROR, STAINLESS STEEL FRAME WITH TEMPERED GLASS 457mm x 914mm (18"w x36"h)
JSN A1132	1	VV	RAIL, ACCESSORY/EQUIPMENT MOUNTING, LENGTH AS REQUIRED (NOT SHOWN)
JSN A5075	1	CC	DISPENSER, SOAP
JSN A5080	1	CC	DISPENSER, PAPER TOWELS, STAINLESS STEEL, SURFACE MOUNTED
JSN A5106	1	VV	WASTE DISPOSAL UNIT, SHARPS W/GLOVE DISPENSER
JSN A5180	1	CC	TRACK, CUBICAL, SURFACE MOUNTED WITH CURTAIN. LENGTH AS REQUIRED
JSN A6046	1	VV	ARTWORK, DECORATIVE, WITH FRAME (NOT SHOWN)
JSN E0222	1	CC	DESK W/ DRAWERS AND BOOKSHELF, 24"D X 36"W X 29"H WORK SURFACE, COMPUTER, O/H CAB, WALL MTD, 48"W.
JSN E0948	1	VV	CART, MOBILE 18"W X 30"L X 36"H CART, MOBILE STORAGE 42"H X 32"W X 22"D.
JSN F0205	1	VV	CHAIR, SIDE WITH ARMS, UPHOLSTERED, 32" HIGH X 21" WIDE X 23" DEEP WITH ARMS, PADDED SEATS AND PADDED BACKS.
JSN F0280	1	VV	CHAIR, SWIVEL, LOW BACK LOW BACK CONTEMPORARY SWIVEL CHAIR, 37" HIGH X 25" WIDE X 31" DEEP WITH A FIVE (5) CASTER SWIVEL BASE.
JSN F0340	1	VV	SELF ADJUSTING STOOL
JSN F3050	1	CC	WHITE CONTAINER, DRY ERASE, 36" H 48" W
JSN F2000	1	VV	WASTE PAPER, ROUND, METAL, 18" DIAMETER
JSN F3200	1	VV	CLOCK, BATTERY OPERATED, 12" DIAMETER
JSN M1620	1	CC	HOLDER, CHART, PATIENT WALL OR DOOR MOUNTED
JSN M1801	1	VV	PC COMPUTER SYSTEM WITH KEYBOARD WER, FLAT PANEL MONITOR, KEYBOARD, MOUSE AND SPEAKERS

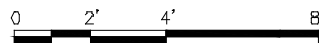
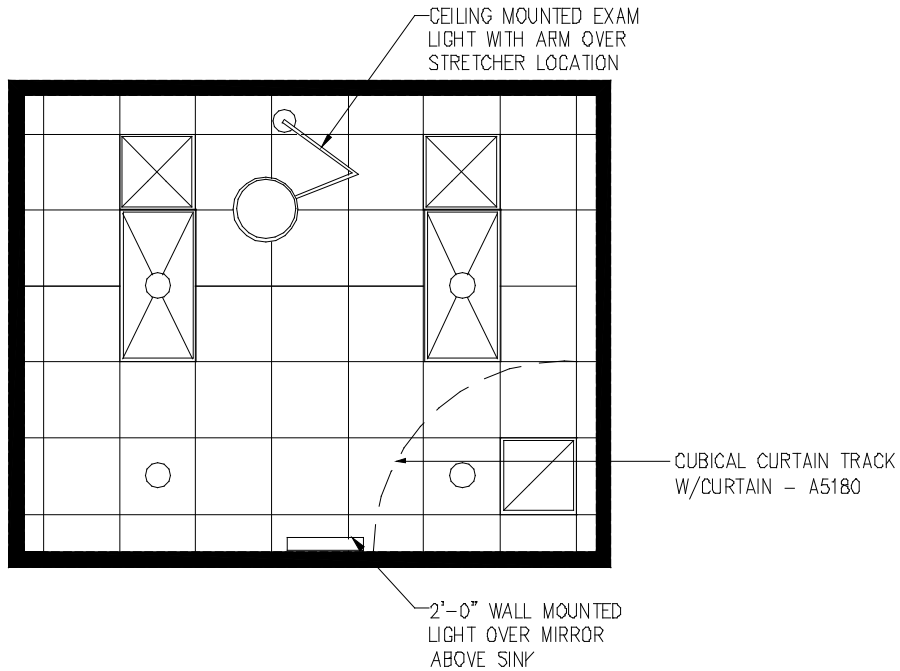
SYMBOL	QUANTITY	AI	DESCRIPTION
JSN M3072	1	VV	FRAME, INFECTIOUS WASTE BAG WITH LID
JSN M4100	1	VV	SPHYGMOMANOMETER, ANEROID, WALL MOUNTED
JSN 4200	1	VV	OTOSCOPE/OPHTHALMOSCOPE, WALL MOUNTED
JSN M4255	1	VV	STAINLESS STEEL ADJUSTABLE, PORTABLE IV STAND
JSN M7400	1	VV	LIGHT, EXAM, TABLE MOUNTED SPOTLIGHT.
JSN M9025	1	VV	TABLE, EXAMINATION/TREATMENT, WITH CABINET
JSN P3100	1	CC	LAVATORY, ELECTRONIC SENSOR CONTROL FAUCET WITH RIGID GOOSENECK SPOUT, 20" X18" X 3-1/2"
JSN X3830	1	VV	ILLUMINATOR, FILM, SINGLE, WALL MOUNTED. APPROXIMATELY 20"H X 17" W X 5"D.
	1	VV	CABINET, INSTRUMENT & DRESSING, APPROX 30"W X 16"D X 60"H
	1	CC	HAMPER, SOILED LINEN, HINGED SELF-CLOSING TOP
	1	CC	NURSE CALL EMERGENCY STATION WITH CORRIDOR SIGNAL LIGHT CONNECTED TO NEAREST NURSE CONTROL STATION

TABLE 7.1
Examination Room

7.2 Treatment Room (TRGM1) – 180 NSF [17.0 NSM] Floor Plan



7.2 Treatment Room (TRGM1) – 180 NSF [17.0 NSM] Reflected Ceiling Plan



7.2 Treatment Room (TRGM1) – 180 NSF [17.0 NSM]

Function:

Provides space for patient treatments, assessments and examinations beyond what can be done in a standard examination room. Specific room equipment requirements should be established based on the particular facility and what services will be provided in this room. Because of the equipment housed in this room, patients should not be left unattended in this space.

Note: Where VA standard items are shown, non-institutional & sustainable options should be considered if feasible.

Space Requirement:

180 NSF [17.0 NSM]

Architectural:

Floor Finish:	Sheet vinyl, linoleum or rubber flooring.
Base:	Rubber Base
Wall Finish:	Gypsum Board, painted finish
Ceiling:	Acoustic Tile
Ceiling Height:	9'-0" minimum
Noise (STC Rating):	STC 40 minimum, STC 45 recommended
Hardware:	VA Hardware #52
Doors:	3'-6" x 7'-0" wood.
Windows:	Not required. If provided, inside face of glazing shall be laminated glass.

HVAC:

Inside Design Condition:	70 degrees F (21C) to 75 degrees F (24C) year round 30% - 50% Relative Humidity
Min. Air Supply Air Change/Hr:	6
Return Air:	Permitted
Exhaust Air:	Not Required
Room Noise Level:	NC 35
Individual Temperature Control:	Required
Room Air Balance:	Neutral

Electrical:

Lighting Levels:	
Gen. Illumination:	50 fc
Task Illumination:	Provided by exam light
Emerg. Illumination:	Provide one emergency light
Emergency Power:	Provide one source
Telecommunications:	As required
Receptacles:	As required

7.2 Treatment Room (TRGM1) – 180 NSF [17.0 NSM]

Equipment Table:

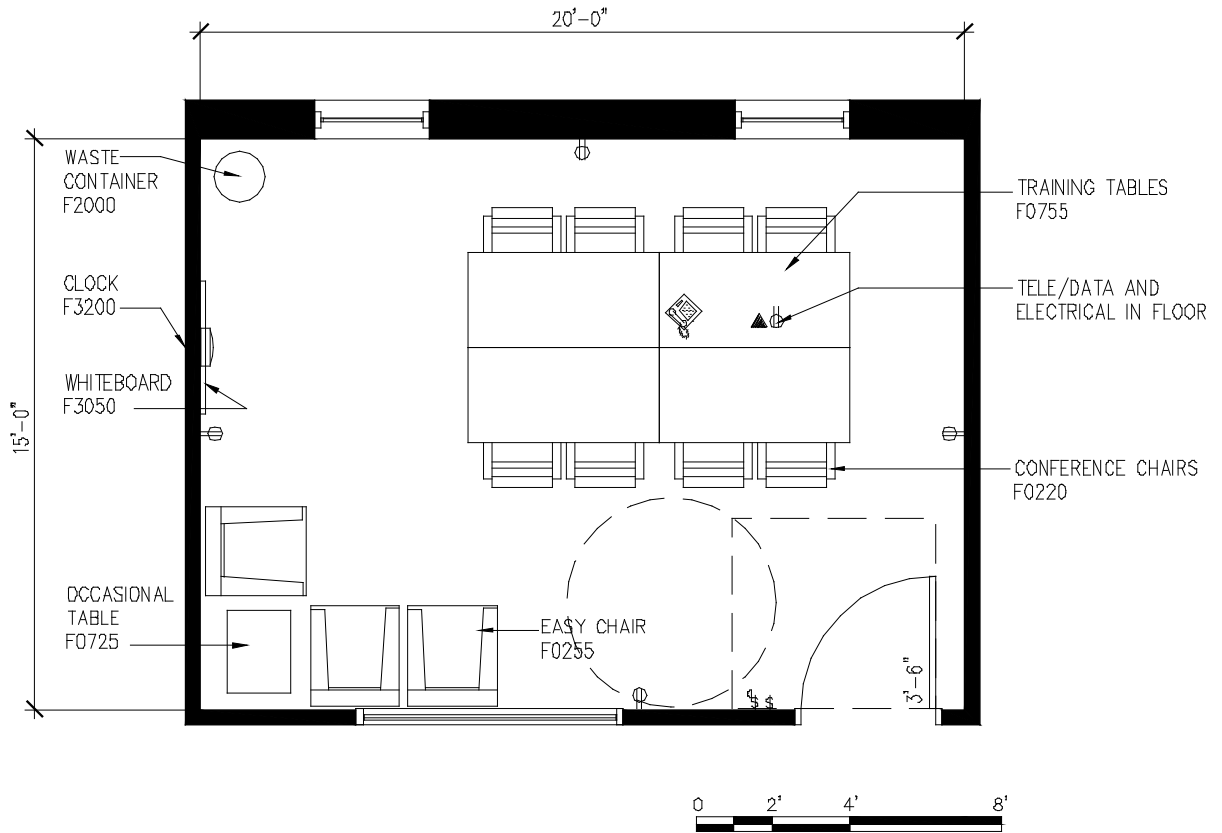
See Legend of Symbols in Section 1.6

SYMBOL	QUANTITY	AI	DESCRIPTION
			Note: Where VA standard items are shown, non-institutional & sustainable options should be considered if feasible.
JSN A1010	1	CC	TELECOMMUNICATION/DATA OUTLET
JSN A1011	1	CC	TELEPHONE, DESK, 1 LINE
JSN A1132	1	VV	RAIL, ACCESSORY MOUNTING, LENGTH AS REQUIRED
JSN A1165	1	VV	TRACK, IV, CEILING MOUNTED, 7ft
JSN A5075	1	VV	DISPENSER, SOAP DISPOSABLE
JSN A5080	1	CC	DISPENSER, PAPER TOWEL, STAINLESS STEEL, SURFACE MOUNTED
JSN A5106	1	VV	WASTE DISPOSAL UNIT, SHARPS W/ GLOVE DISPENSER
JSN A5145	1	CC	HOOK, GARMENT, DOUBLE, STAINLESS STEEL, SURFACE MOUNTED
JSN A5180	1	CC	TRACK, CUBICLE, SURFACE MOUNTED, WITH CURTAIN
NO JSN	AR	CC	CASEWORK AS REQUIRED WITH SOLID SURFACE COUNTERTOP
JSN P3100	1	CC	VITREOUS CHINA SLAB TYPE LAVATORY
JSN E0915	1	CC	LOCKER, SUPPLY, MEDICATION, WAL MTD. 23"w X 20"d
JSN E0954	1	CC	CART, EMERGENCY, MOBILE, 66"h X 52"w X 22"d
JSN E1500	1	VV	RAIL, WALL MOUNTED (NOT SHOWN)
JSN F0205	1	VV	CHAIR, SIDE WITH ARMS- 32"h X 19"w X 23"d
JSN F0340	1	VV	STOOL, SELF ADJUSTING
JSN F2000	1	VV	WASTE CONTAINER, ROUND, METAL 18"h X 16"dia.
JSN F3200	1	VV	CLOCK, BATTERY, 305mm dia. (12"dia.)
JSN M0750	1	VV	FLOWMETER, AIR, CONNECT W/ 50psi SUPPLY
JSN M0755	1	VV	FLOWMETER, OXYGEN, LOW FLOW
JSN M0765	1	VV	REGULATOR, VACUUM
JSN M1620	1	CC	HOLDER, CHART, PATIENT WALL OR DOOR MOUNTED
JSN M1801	1	VV	COMPUTER, MICROPROCESSING W/ FLAT PANEL MONITOR
JSN M3070	1	VV	HAMPER, LINEN, MOBILE W/ LID
JSN M3072	1	VV	FRAME, INFECTIOUS WASTE BAG W/ LID
JSN M4100	1	VV	SPHYGMOMANOMETER, ANEROID, WALL MOUNTED

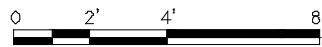
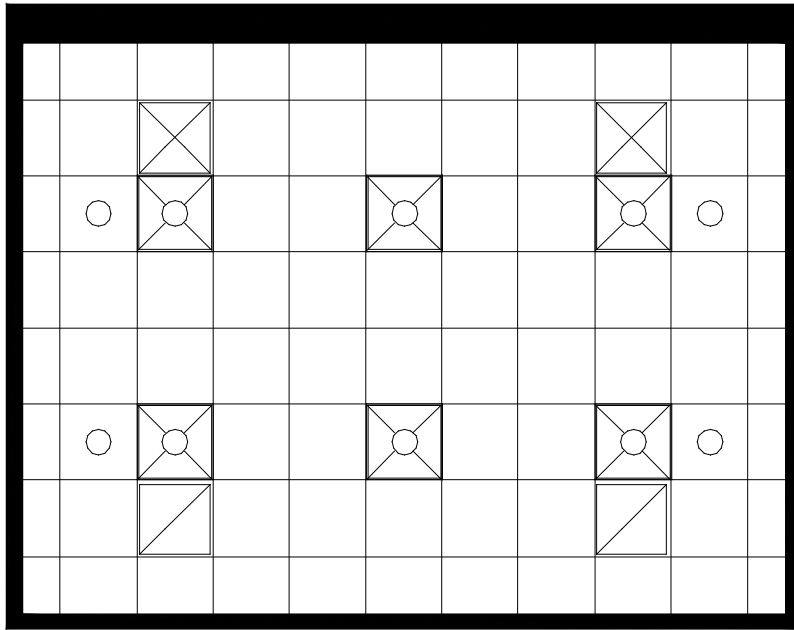
SYMBOL	QUANTITY	AI	DESCRIPTION
JSN M4116	1	VV	MONITOR, VITAL SIGNS
M4200	1	VV	OTOSCOPE/OPHTHALMOSCOPE, WALL MOUNTED
M4255	1	VV	STAND, IV, ADJUSTABLE
M4266	1	VV	PUMP, VOLUMETRIC, INFUSION, MULTIPLE LINE (NOT SHOWN)
M4655	1	VV	STRETCHER, MOBILE, CRS, 9 POSITION
M7405	1	CC	LIGHT EXAM, CEILING MOUNTED
M7660	1	CC	DEFIBRILLATOR/MONITOR/RECORDER, PORTABLE (NOT SHOWN)
M7710	1	VV	ELECTROCARDIOGRAPH, 12 LEAD, PORTABLE
M7905	1	VV	OXIMETER, PULSE (NOT SHOWN)
M8810	1	VVV	STAND, MAYO
X3930	1	VV	ILLUMINATOR, FILM, SINGLE, WALL MOUNTED

TABLE 7.2
Treatment Room

7.3 Group Therapy Room (OPMH1) – 300 NSF [27.9 NSM] Floor Plan



7.3 Group Therapy Room (OPMH1) – 300 NSF [27.9 NSM] Reflected Ceiling Plan



7.3 Group Therapy Room (OPMH1) – 300 NSF [27.9 NSM]

Function:

This room may or may not have an adjacent control room.

Note: Where VA standard items are shown, non-institutional & sustainable options should be considered if feasible.

Space Requirement:

300 NSF [27.9 NSM]

Architectural:

Floor Finish:	Carpet, carpet tile or resilient flooring.
Base:	Rubber Base
Wall Finish:	Gypsum Board - Painted
Ceiling:	Acoustic Tile
Ceiling Height:	9'-0" Min.
Noise (STC Rating):	STC 45 minimum.
Hardware:	VA Hardware Set # 52
Doors:	3'-6" x 7'-0" wood with ½ light glazing. 3'-0" minimum width
Windows:	Not required. If provided, inside layer of exterior window units shall be laminated glass. Interior glazing shall be laminated glass. Integral blinds for sun control are preferred but not required

Mechanical:

Inside Design Condition:	70 degrees F (21C) to 75 degrees F (24C) year round 30% -50% Relative Humidity
Min. Air Supply Air Change/Hr:	6
Return Air:	Permitted
Exhaust Air:	Not Required
Room Noise Level:	NC 35
Individual Temperature Control:	Required
Room Air Balance:	Neutral

Electrical:

Lighting Levels:	
Gen. Illumination:	50 fc
Suppl. Illumination:	Dimmable Fluorescent down lights
Emerg. Illumination:	As required
Emergency Power:	As required
Receptacles:	As required

7.3 Group Therapy Room (OPMH1) – 300 NSF [27.9 NSM]

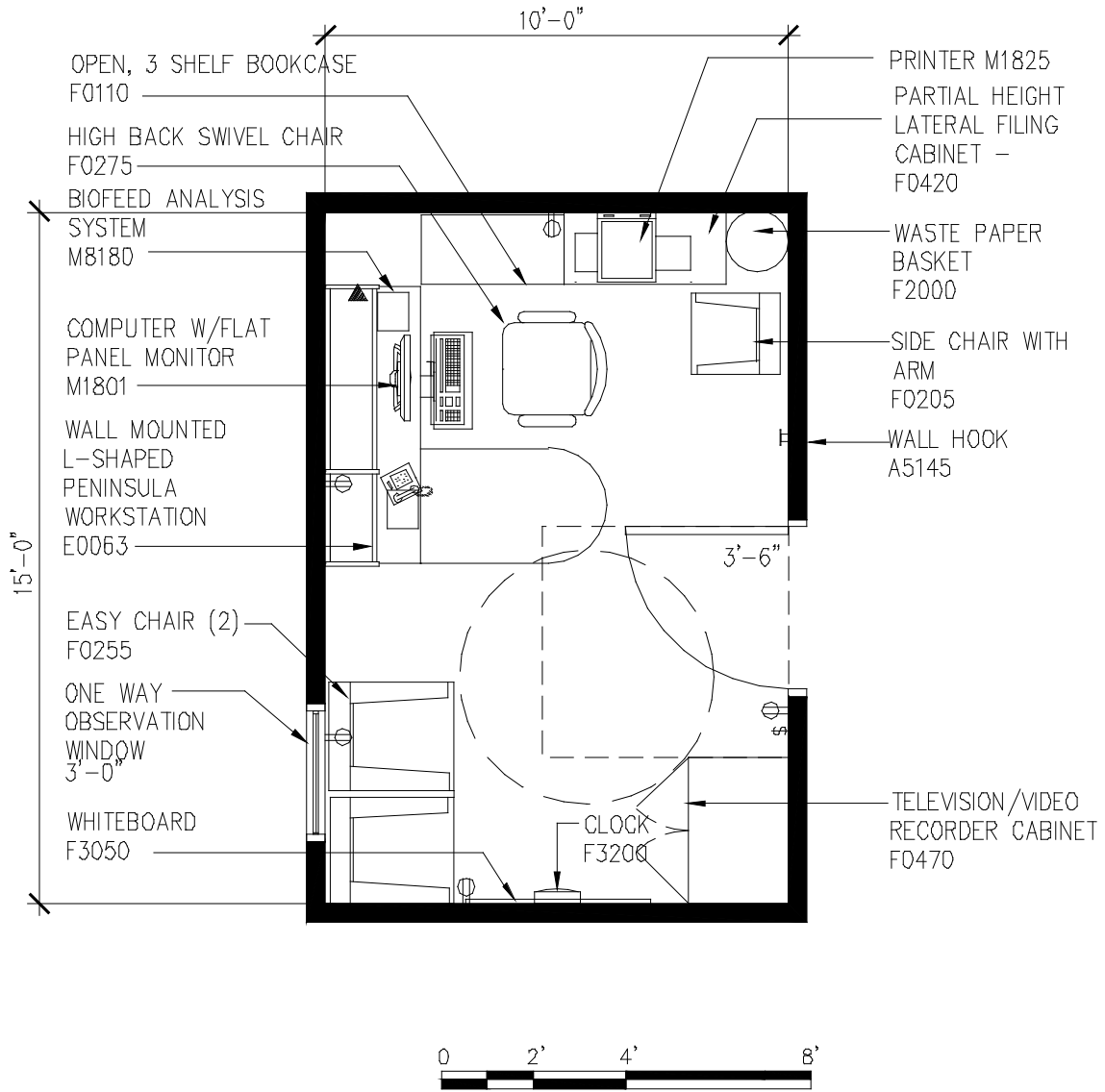
Equipment Table:

See Legend of Symbols in Section 1.6

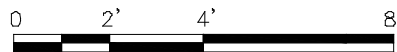
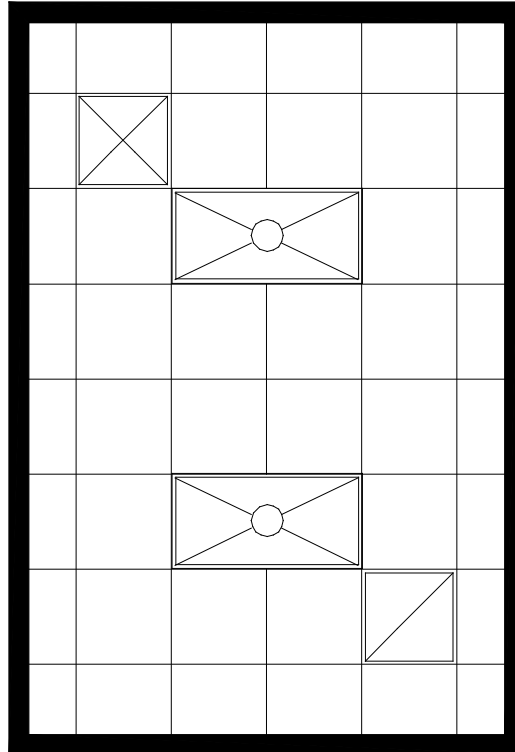
SYMBOL	QUANTITY	AI	DESCRIPTION
			Note: Where VA standard items are shown, non-institutional & sustainable options should be considered if feasible.
JSN A1010	1	CC	TELECOMMUNICATION/DATA OUTLET, FLOOR MOUNTED BELOW TABLE
JSN A1011	1	CC	TELEPHONE, 1 LINE, FLOOR MOUNTED BELOW TABLE
JSN F0220	AR	VV	CHAIR, CONFERENCE
JSN F0255	AR	VV	CHAIR, EASY, 35" H X 28" W X 32" D
JSN F0755	AR	VV	SEMINAR TABLES, 609mm x 1522mm x 761mm (24"w x 60"l x 30"h)
JSN F3050	1	CC	MARKER BOARD-WHITE PORCELAIN
JSN F3200	1	CC	CLOCK 305mm dia. (12"dia.)
JSN F2000	1	VV	WASTE CONTAINER, ROUND METAL, 457mm x 406mm dia. (18"h x 16"dia.)

TABLE 7.3
Group Therapy Room

7.4 Group Testing Room (OPMH2) - 150 NSF [13.9 NSM] Floor Plan



7.4 Group Testing Room (OPMH2) - 150 NSF [13.9 NSM] Reflected Ceiling Plan



7.4 Group Testing Room (OPMH2) - 150 NSF [13.9 NSM]

Function: This space allows two to three patients to confer with a mental health professional in an office like setting. Furniture and door should be arranged in this space so both patients and professionals can exit the room without passing in front of the other.

Note: Where VA standard items are shown, non-institutional & sustainable options should be considered if feasible.

Space Requirement:

Group Testing Room: 150 NSF [13.9 NSM]

Architectural:

Floor Finish:	Carpet, carpet tile or resilient flooring
Base:	Rubber Base
Wall Finish:	Gypsum Board - Painted
Ceiling:	Acoustic Tile with clips or Gypsum Board with Acoustical Plaster
Ceiling Height:	9'-6" Min.
Noise (STC Rating):	STC 45 minimum.
Hardware:	VA Hardware Set # 52
Doors:	3'-6" x 7'-0" wood with ½ light glazing.
Windows:	Not required. If provided, inside layer of exterior window units shall be laminated glass. Interior glazing shall be laminated glass. Integral blinds for sun control are preferred but not required.

Mechanical:

Inside Design Condition:	70 degrees F (21C) to 75 degrees F (24C) year round 30% -50% Relative Humidity
Min. Air Supply Air Change/Hr:	4
Return Air:	Permitted
Exhaust Air:	Not Required
Room Noise Level:	NC 35
Individual Temperature Control:	Preferred
Room Air Balance:	Neutral

Electrical:

Lighting Levels:	
Gen. Illumination:	50 fc
Suppl. Illumination:	Dimmable Fluorescent down lights
Emerg. Illumination:	As required
Emergency Power:	As required
Receptacles:	As required

7.4 Group Testing Room (OPMH2) - 150 NSF [13.9 NSM]

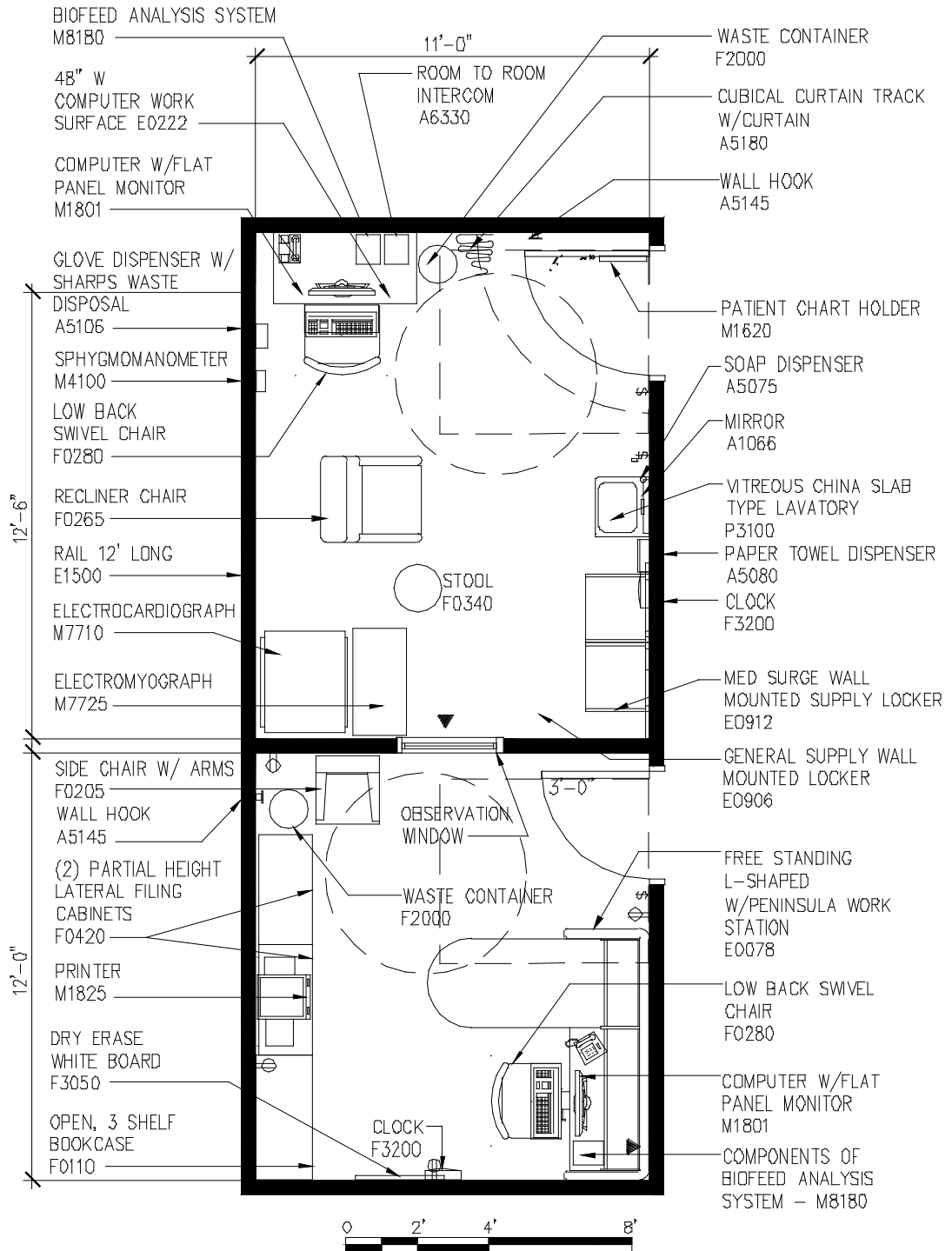
Equipment Table:

See Legend of Symbols in Section 1.6

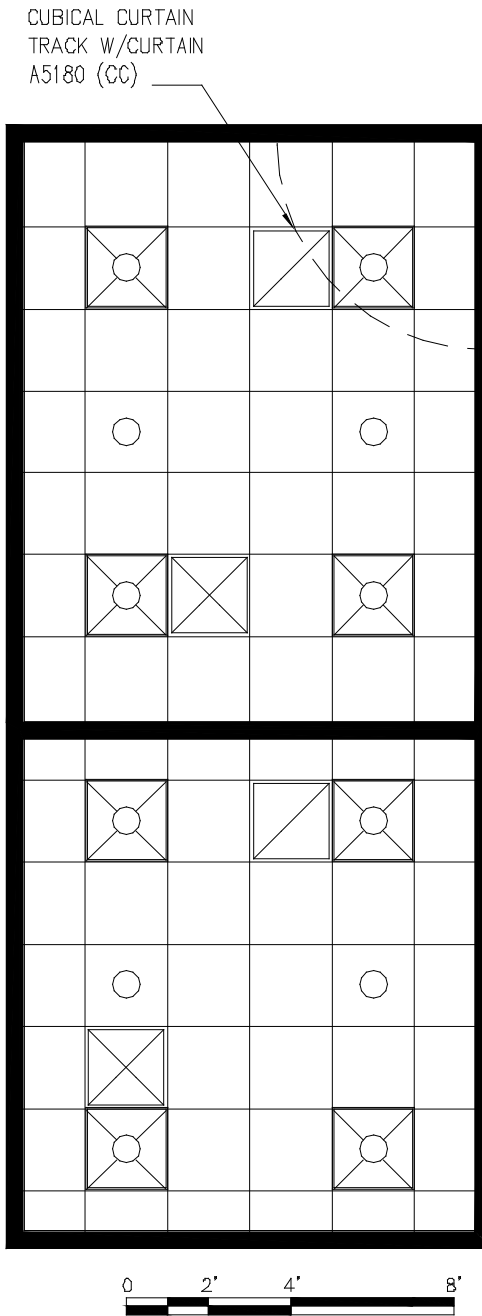
SYMBOL	QUANTITY	AI	DESCRIPTION
			Note: Where VA standard items are shown, non-institutional & sustainable options should be considered if feasible.
JSN A1010	1	CC	TELECOMMUNICATION/DATA OUTLET
JSN A1011	1	CC	TELEPHONE, 1 LINE
JSN A5120	1	CC	WINDOW, OBSERVATION, ONE WAY, (36"w x 36"h)
JSN A5145	1	CC	HOOK, GARMENT, SURFACE MOUNTED
JSN E0063	1	VV	WALL HUNG L-SHAPED WORKSTATION W/PENINSULA. 72" x 72"
JSN F0110	1	VV	BOOK CASE WITH THREE (3) ADJUSTABLE SHELVES
JSN F0205	1	VV	CHAIR, SIDE WITH ARMS, UPHOLSTERED SIDE CHAIR, 32" HIGH X 21" WIDE X 23" DEEP WITH ARMS, PADDED SEATS AND PADDED BACKS. SEAT HEIGHT IS A MINIMUM OF 17"
JSN F0255	AR	WW	CHAIR, EASY, 35" H X 28" W X 32" D
JSN F0275	1	VV	CHAIR, SWIVEL, HIGH BACK, 41" H X 23" W X 23" D
JSN F3050	1	CC	WHITEBOARD, DRY ERASE, 36" H X 48" W
JSN F0420	1	VV	CABINET, FILING, LATERAL, PARTIAL HEIGHT
JSN F0470	1	VV	CABINET, TELEVISION/VIDEO RECORDER
JSN F0750	1	VV	TABLE, OFFICE (SIZE AS REQUIRED) (NOT SHOWN)
JSN F2000	1	VV	WASTE CONTAINER, ROUND, METAL, (18"h x 16"dia.)
JSN F2050	1	VV	RECORDER, CASSETTE TAPE, AUDIO (NOT SHOWN)
JSN F2250	1	VV	CAMERA, PORTABLE, CCTV, WITH RECORDER (NOT SHOWN)
JSN F3200	1	VV	CLOCK, BATTERY OPERATED, 12" DIAMETER
JSN M1801	1	VV	PC COMPUTER SYSTEM WITH KEYBOARD DESK TOP MICROPROCESSING COMPUTER
JSN M1825	1	VV	COMPUTER PRINTER
JSN M8180	1	VV	COMPUTER BASED BIOFEEDBACK TESTING AND ANALYSIS SYSTEM AND ANALYSIS

TABLE 7.4
Group Testing Room

7.5 Biofeedback Laboratory Treatment Room (OPMH3) -
 150 NSF [13.9 NSM]
 Biofeedback Laboratory Control Room / Office (CMP02) -
 120 NSF [11.2 NSM]
 Floor Plan



7.5 Biofeedback Laboratory Treatment Room (OPMH3) -
150 NSF [13.9 NSM]
Biofeedback Laboratory Control Room / Office (CMP02) -
120 NSF [11.2 NSM]
Reflected Ceiling Plan



7.5 Biofeedback Laboratory Treatment Room (OPMH3) - 150 NSF [13.9 NSM] Biofeedback Laboratory Control Room / Office (CMP02) - 120 NSF [11.2 NSM]

Function: This space with the adjacent control room accommodates computerized equipment, such as biofeedback equipment, used in testing mental health outpatients. It should be noted that biofeedback equipment is more compact and portable. Dedicated rooms for this type of equipment are becoming less frequent in new VA facilities.

Note: Where VA standard items are shown, non-institutional & sustainable options should be considered if feasible.

Space Requirement:

Biofeedback Laboratory Treatment Room: 150 NSF [13.9 NSM]

Biofeedback Control Room: 120 NSF [11.2 NSM]

Biofeedback Laboratory Treatment Room

Architectural:

Floor Finish:	Sheet Vinyl, linoleum or rubber flooring
Base:	Rubber Base
Wall Finish:	Gypsum Board - Painted
Ceiling:	Acoustic Tile
Ceiling Height:	9'-0" Min.
Noise (STC Rating):	STC 45 minimum
Hardware:	VA Hardware Set # 52
Doors:	3'-6" x 7'-0" wood with ½ light glazing. 3'-0" minimum
Windows:	Exterior windows not required. One way mirrored interior glazing between lab and control room should be laminated glass

Mechanical:

Inside Design Condition:	70 degrees F (21C) to 75 degrees F (24C) year round 30% -50% Relative Humidity
Min. Air Supply Air Change/Hr:	4
Return Air:	Permitted
Exhaust Air:	Not Required
Room Noise Level:	NC 35
Individual Temperature Control:	Preferred
Room Air Balance:	Neutral

Electrical:

Lighting Levels:	
Gen. Illumination:	50 fc
Suppl. Illumination:	Dimmable Fluorescent down lights
Emerg. Illumination:	As required
Emergency Power:	As required
Receptacles:	As required

Biofeedback Laboratory Control Room / Office**Architectural:**

Floor Finish:	Carpet, carpet tile or resilient flooring
Base:	Rubber Base
Wall Finish:	Gypsum Board - Painted
Ceiling:	Acoustic Tile
Ceiling Height:	9'-0" Min.
Noise (STC Rating):	STC 45 minimum.
Hardware:	VA Hardware Set # 52
Doors:	3'-6" x 7'-0" wood with ½ light glazing.
Windows:	Exterior windows not required. One way mirrored interior glazing between lab and control room should be laminated glass

Mechanical:

Inside Design Condition:	70 degrees F (21C) to 75 degrees F (24C) year round 30% -50% Relative Humidity
Min. Air Supply Air Change/Hr:	4
Return Air:	Permitted
Exhaust Air:	Not Required
Room Noise Level:	NC 35
Individual Temperature Control:	Required
Room Air Balance:	Neutral

Electrical:

Lighting Levels:	
Gen. Illumination:	50 fc
Suppl. Illumination:	Dimmable Fluorescent down lights
Emerg. Illumination:	As required
Emergency Power:	As required
Receptacles:	As required

7.5 Biofeedback Laboratory Treatment Room (OPMH3) -
150 NSF [13.9 NSM]
Biofeedback Laboratory Control Room / Office (CMP02) -
120 NSF [11.2 NSM]

Equipment Table:

See Legend of Symbols in Section 1.6

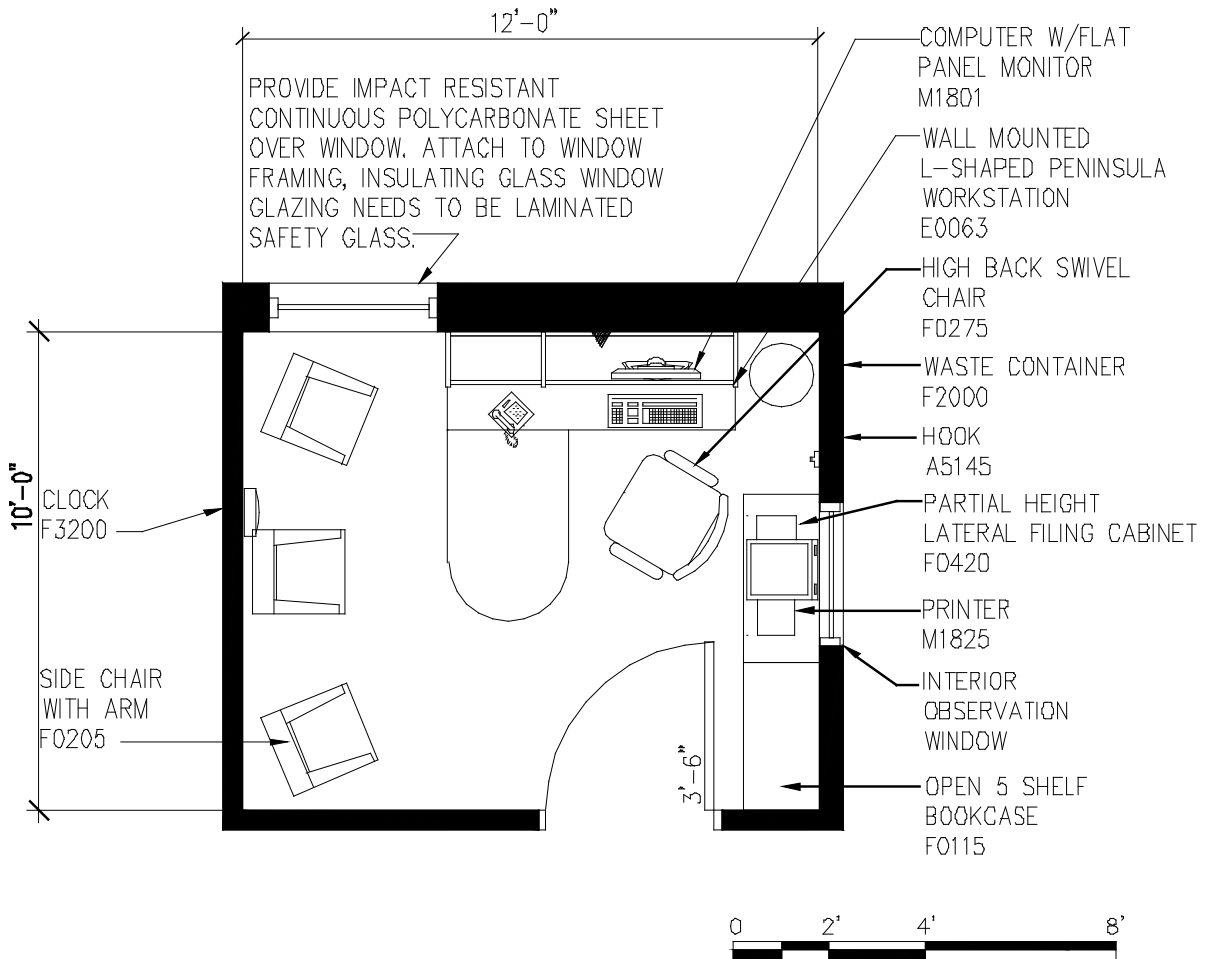
SYMBOL	QUANTITY	AI	DESCRIPTION
			<i>Note: Where VA standard items are shown, non-institutional & sustainable options should be considered if feasible.</i>
BIOFEEDBACK LABORATORY TESTING ROOM			
JSN A1010	1	CC	TELECOMMUNICATION/DATA OUTLET
JSN A1011	1	CC	TELEPHONE, 1 LINE
JSN A1066	1	CC	MIRROR, STAINLESS STEEL FRAME WITH TEMPERED GLASS 457mm x 914mm (18"x36")
JSN A5075	1	VV	DISPENSER, SOAP, DISPOSABLE. ONE-HANDED DISPENSING OPERATION
JSN A5080	1	CC	DISPENSER, PAPER TOWELS, STAINLESS STEEL SURFACE MOUNTED
JSN A5106	1	VV	WASTE DISPOSAL UNIT, SHARPS W/GLOVE DISPENSER
JSN A5145	1	CC	HOOK, GARMENT, SURFACE MOUNTED
JSN A5180	1	CC	TRACK, CUBICAL, SURFACE MOUNTED WITH CURTAIN
JSN A6330	1	CC	INTERCOM -ROOM TO ROOM
JSN E0123	1	VV	WORKSTATION, STRAIGHT, FREE STANDING, 72"W.
JSN E0906	1	VV	LOCKER, SUPPLY, GENERAL, WALL MOUNTED, 23"W X 20"D
JSN E0912	1	VV	LOCKER, SUPPLY, MED SURG, WALL MOUNTED, 23"W X 20"D. (Consider the need for an E0921 to transport the locker from place to place)
JSN E1500	1	VV	RAIL, MOD, W/MNTD, XS144XD. (Wall mounted rail used for hanging (mounting) lockers, shelves, drawers on a wall)
JSN F0265	AR	VV	CHAIR, RECLINER
JSN F0280	1	VV	CHAIR, SWIVEL, LOW BACK
JSN F0340	1	VV	SELF ADJUSTING STOOL
JSN F2000	1	VV	WASTE CONTAINER, ROUND, METAL, 18" DIAMETER
JSN F3200	1	VV	CLOCK, BATTERY OPERATED, 12" DIAMETER

SYMBOL	QUANTITY	AI	DESCRIPTION
JSN M1620	1	CC	HOLDER, CHART, PATIENT WALL OR DOOR MOUNTED
JSN M1801	1	VV	DESK TOP MICROPROCESSING COMPUTER
JSN M4100	1	VV	SPHYGMOMANOMETER, ANEROID, WALL MOUNTED
JSN M7710	1	VV	ELECTROCARDIOGRAPH, 12 LEAD, PORTABLE
JSN M7725	1	VV	ELECTROMYOGRAPH
JSN M8180	1	VV	COMPUTER BASED BIOFEEDBACK TESTING AND ANALYSIS SYSTEM. UNIT ACCEPTS ELECTROENCEPHALOGRAPH (EEG), ELECTROMYOGRAPHY (EMG)
JSN P3100	1	CC	LAVATORY, VITREOUS CHINA, SLAB TYPE. WALL MOUNTED, (BOWL SIZE 7"X15"X10")
BIOFEEDBACK LABORATORY CONTROL ROOM			
JSN A1010	1	CC	TELECOMMUNICATION/DATA OUTLET
JSN A1015	1	CC	TELEPHONE, MULTIPLE LINE
JSN A5145	1	CC	HOOK, GARMENT, SURFACE MOUNTED
JSN A6046	1	VV	ARTWORK, DECORATIVE, WITH FRAME (NOT SHOWN)
JSN E0078	1	VV	FREE STANDING L-SHAPED WORKSTATION W/PENINSULA. 78" X 72"
JSN F0110	1	VV	BOOKCASE WITH THREE (3) ADJUSTABLE SHELVES
JSN F0205	1	VV	CHAIR, SIDE WITH ARMS UPHOLSTERED SIDE CHAIR, 32" HIGH X 21" WIDE X 23" DEEP WITH ARMS, SEAT HEIGHT IS A MINIMUM OF 17"
JSN F0280	1	VV	CHAIR, SWIVEL, LOW BACK 37" HIGH X 25" WIDE X 31" DEEP WITH A FIVE (5) CASTER SWIVEL
JSN F0420	2	VV	CABINET, FILING, LATERAL, HALF HEIGHT
JSN F2000	1	VV	BASKET, WASTE PAPER, ROUND, METAL, 18" DIAMETER
JSN F3050	1	CC	WHITEBOARD, DRY ERASE, 36" H X 48" W
JSN F3200	1	VV	CLOCK, BATTERY OPERATED, 305mm dia.(12"dia.)
JSN M1801	1	VV	PC COMPUTER SYSTEM WITH KEYBOARD THE UNIT SHALL CONSIST OF A CENTRAL PROCESSING MINI TOWER, FLAT PANEL MONITOR, KEYBOARD, MOUSE AND SPEAKERS
JSN M1825	1	VV	COMPUTER PRINTER
JSN M8180	1	VV	COMPONENTS OF BIOFEEDBACK ANALYSIS SYSTEM

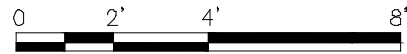
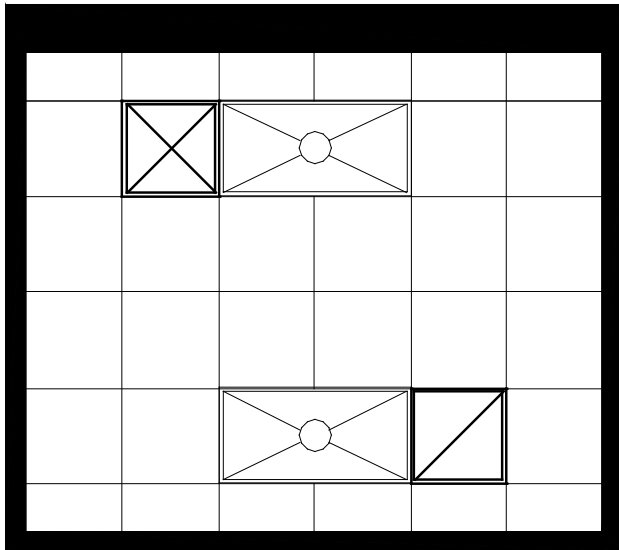
TABLE 7.5

Biofeedback Laboratory Testing Room

7.6 Office, Counselor - (OFD01) - 120 NSF [11.2 NSM]
Floor Plan



7.6 Office, Counselor - (OFD01) - 120 NSF [11.2 NSM]
Reflected Ceiling Plan



7.6 Office, Counselor - (OFD01) - 120 NSF [11.2 NSM]

Function: These offices will be used by Social Work, Psychiatry, Nursing and other mental health professionals. Consultation with patients, family members and other professional staff may take place in these offices. Furniture should be located so that either patient or professional can exit the room without having to pass in front of each other.

Note: Where VA standard items are shown, non-institutional & sustainable options should be considered if feasible.

Space Requirement:

Office, Counselor: 120 NSF [11.2 NSM]

Office, Counselor

Architectural:

Floor Finish:	Carpet or carpet tile.
Base:	Rubber Base
Wall Finish:	Gypsum Board - Painted
Ceiling:	Acoustic Tile
Ceiling Height:	9'-0" Mi
Noise (STC Rating):	STC 45 minimum.
Hardware:	VA Hardware Set # 52
Doors:	3'-6" x 7'-0" wood with ½ light glazing. 3'-0" minimum width
Windows:	Not required. If provided, inside layer of exterior window units shall be laminated glass. Interior glazing shall be laminated glass. Integral blinds for sun control are preferred but not required.

Mechanical:

Inside Design Condition:	70 degrees F (21C) to 75 degrees F (24C) year round 30% -50% Relative Humidity
Min. Air Supply Air Change/Hr:	4
Return Air:	Permitted
Exhaust Air:	Not Required
Room Noise Level:	NC 35
Individual Temperature Control:	Required.
Room Air Balance:	Neutral.

Electrical:

Lighting Levels:	
Gen. Illumination:	50 fc
Suppl. Illumination:	Dimmable Fluorescent down lights
Emerg. Illumination:	As required
Emergency Power:	As required
Receptacles:	As required

7.6 Office, Counselor - (OFD01) - 120 NSF [11.2 NSM]

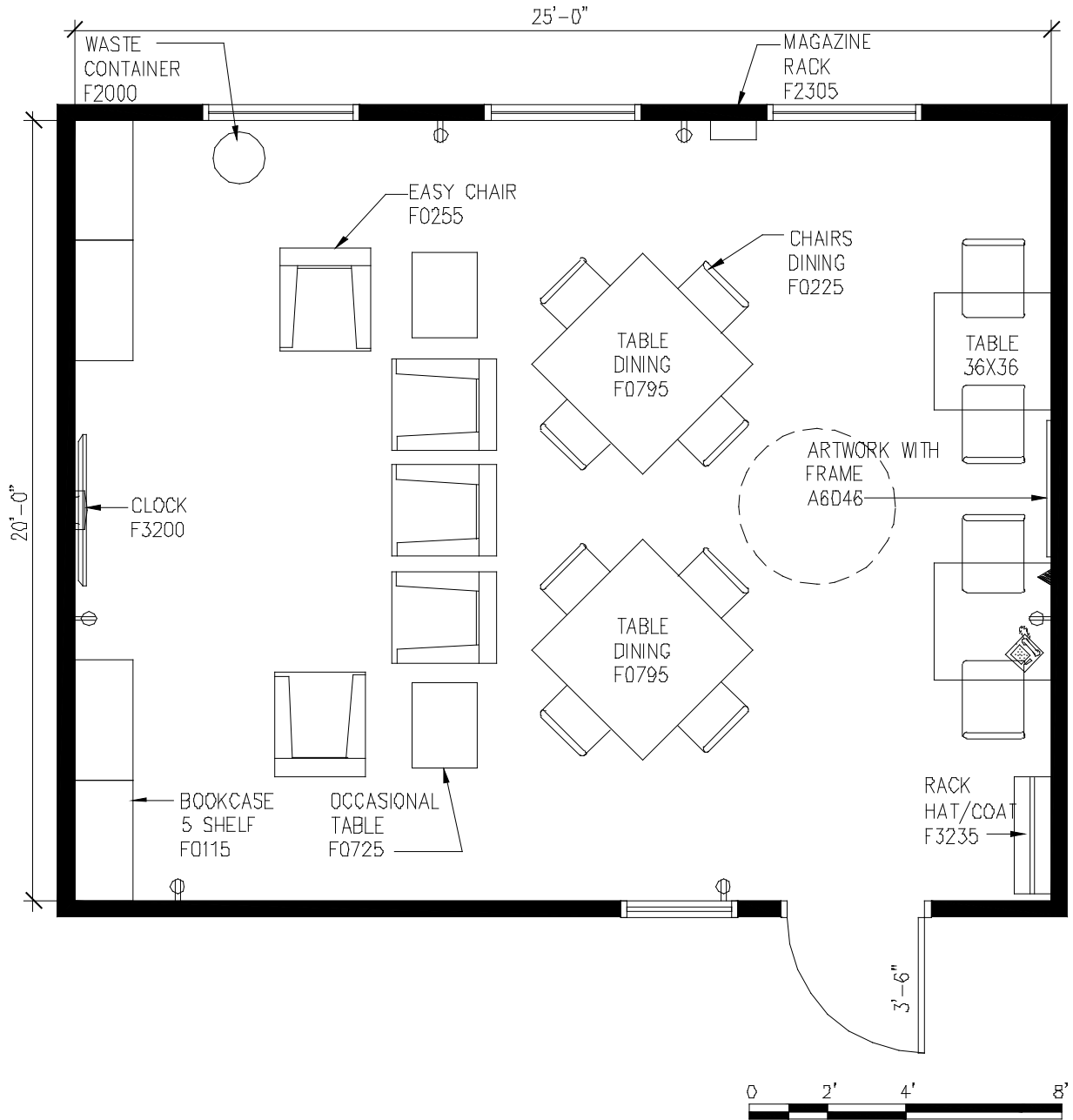
Equipment Table:

See Legend of Symbols in Section 1.6

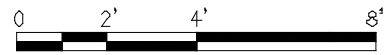
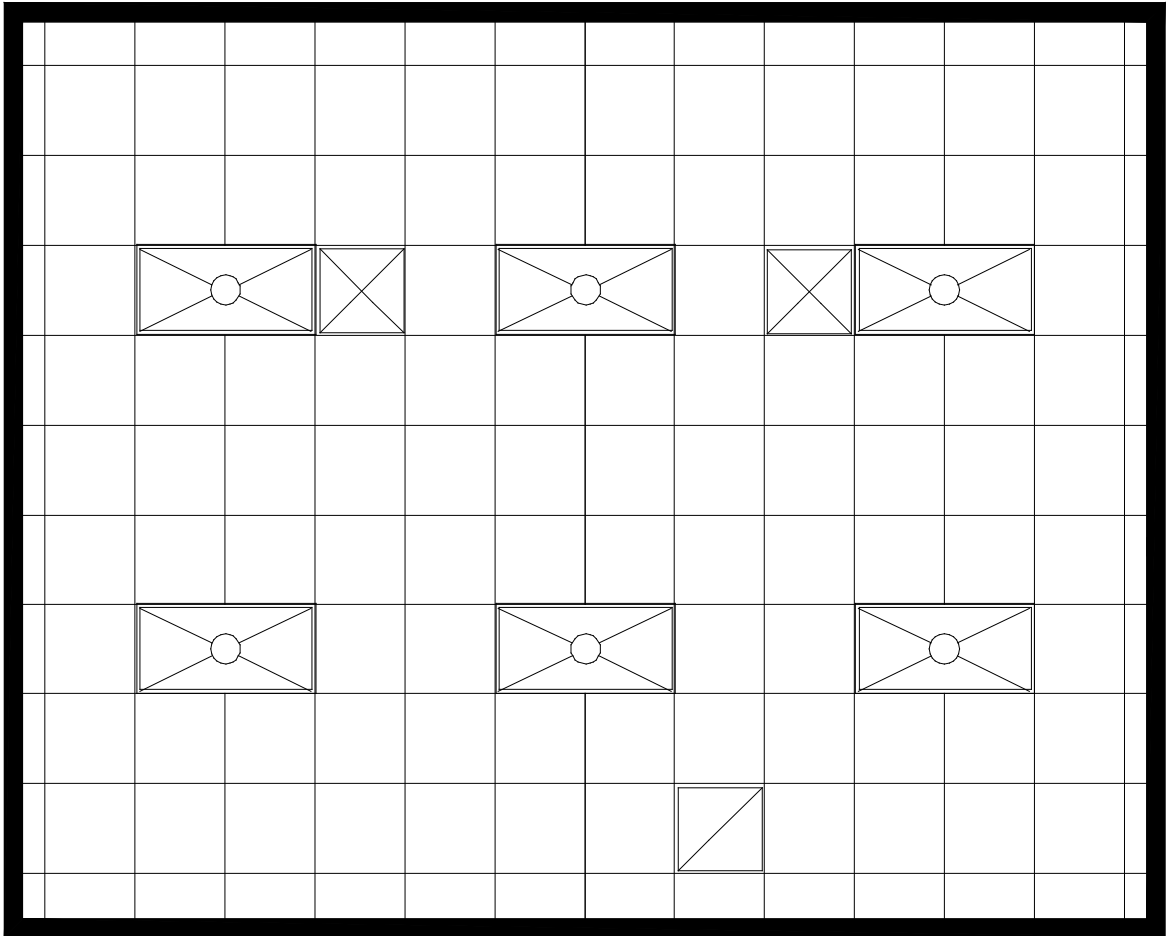
SYMBOL	QUANTITY	AI	DESCRIPTION
			<i>Note: Where VA standard items are shown, non-institutional & sustainable options should be considered if feasible.</i>
JSN A1010	1	CC	TELECOMMUNICATION OUTLET
JSN A1011	1	CC	TELEPHONE, 1 LINE
JSN A5145	1	CC	HOOK, GARMENT, SURFACE MOUNTED (NOT SHOWN)
JSN A6046	1	VV	ARTWORK (NOT SHOWN)
JSN E0063	1	VV	WALL HUNG L-SHAPED WORKSTATION W/PENINSULA. 72" X 72"
JSN F0115	1	VV	BOOKCASE, WITH FIVE (5) ADJUSTABLE SHELVES
JSN F0205	TBD	VV	CHAIR SIDE WITH ARMS
JSN F0275	1	VV	CHAIR, SWIVEL, HIGH BACK
JSN F0420	1	VV	CABINET, FILING, LATERAL, PARTIAL HEIGHT
JSN F2000	1	VV	WASTE CONTAINER, ROUND, METAL
JSN F3200	1	VV	CLOCK, BATTERY OPERATED
JSN M1801	1	VV	PC COMPUTER SYSTEM WITH KEYBOARD
JSN M1825	1	VV	COMPUTER PRINTER

TABLE 7.6
Office, Counselor

7.7 Social Activities / Dining / Multi-Purpose (SL001) – 500 NSF [46.5 NSM] Floor Plan



7.7 Social Activities / Dining / Multi-Purpose (SL001) –
500 NSF [46.5 NSM]
Reflected Ceiling Plan



7.7 Social Activities / Dining / Multi-Purpose (SL001) – 500 NSF [46.5 NSM]

Function: This area will be used for a variety of non structured activities. All patient dining in the PRRC will occur in this room. It is recommended a teaching kitchen be adjacent to this space with a demountable wall partition so that patients can participate in hands on cooking instruction then dine in this area.

Note: Where VA standard items are shown, non-institutional & sustainable options should be considered if feasible.

Space Requirement:

Social Activities / Dining / Multi-Purpose: 500 NSF [46.5 NSM]

Architectural:

Floor Finish:	Sheet vinyl, linoleum or rubber flooring.
Base:	Rubber Base
Wall Finish:	Gypsum Board - Painted
Ceiling:	Acoustic Tile with clips or Gypsum Board with Acoustical Plaster
Ceiling Height:	9'-6" Min.
Noise (STC Rating):	Sound insulation from adjacent spaces critical. Provide STC 40 as a minimum and STC 45 for walls adjacent to resident rooms, group therapy rooms and conference rooms
Hardware:	VA Hardware Set # 52
Doors:	3'-6" x 7'-0" wood with ½ light glazing if partitions are utilized.
Windows:	Not required. If provided, inside layer of exterior window units shall be laminated glass. Interior glazing shall be laminated glass. Integral blinds for sun control are preferred but not required

Mechanical:

Inside Design Condition:	70 degrees F (21C) to 75 degrees F (24C) year round 30% -50% Relative Humidity
Min. Air Supply Air Change/Hr:	6
Return Air:	Permitted
Exhaust Air:	Not Required
Room Noise Level:	NC 40
Individual Temperature Control:	Required
Room Air Balance:	Neutral

Electrical:

Lighting Levels:	
Gen. Illumination:	30 fc
Task Illumination:	Not required
Emerg. Illumination:	Provide one source
Emergency Power:	As required
Receptacles:	As required

7.7 Social Activities / Dining / Multi-Purpose (SL001) – 500 NSF [46.5 NSM]

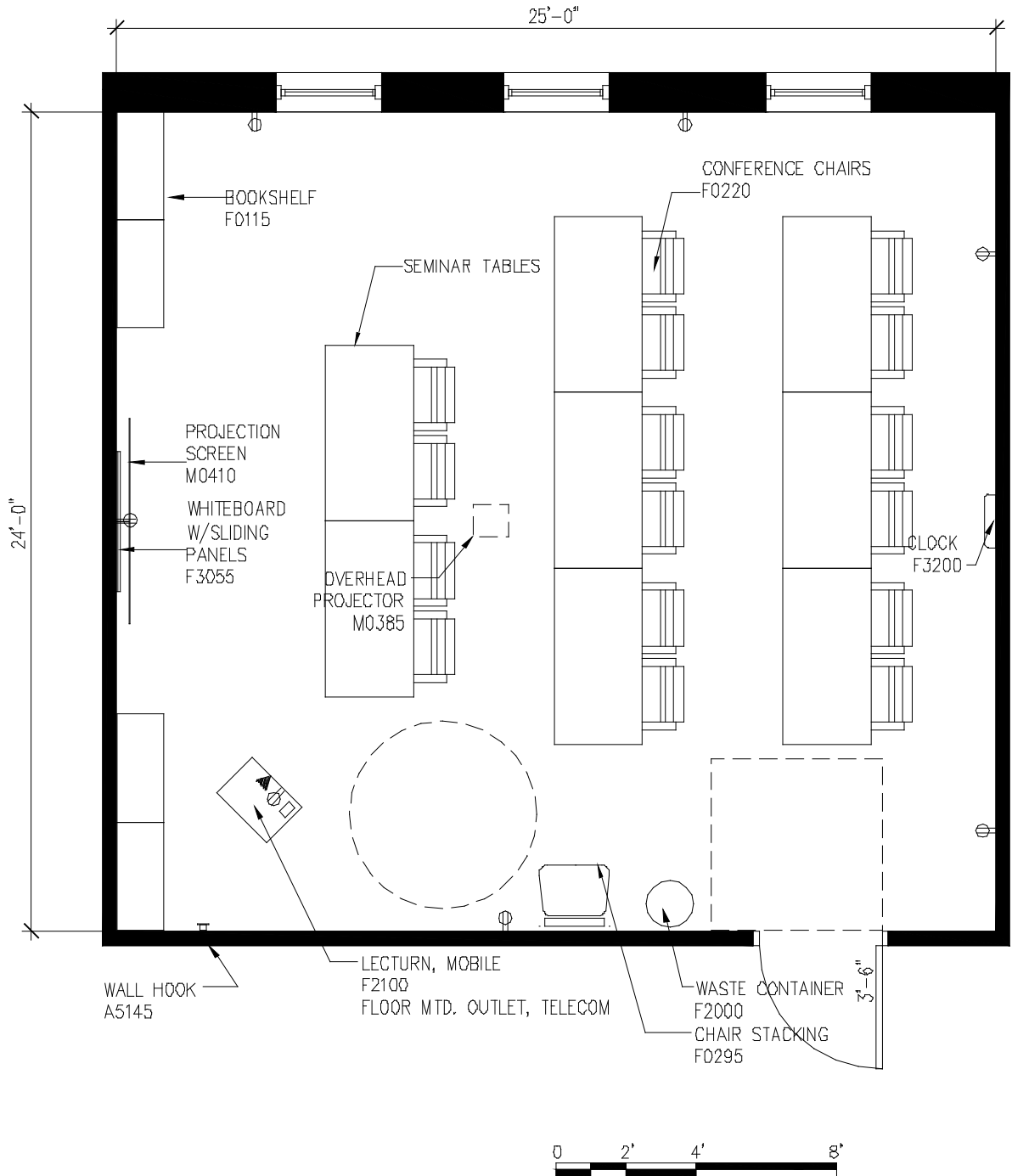
Equipment Table:

See Legend of Symbols in Section 1.6

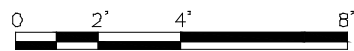
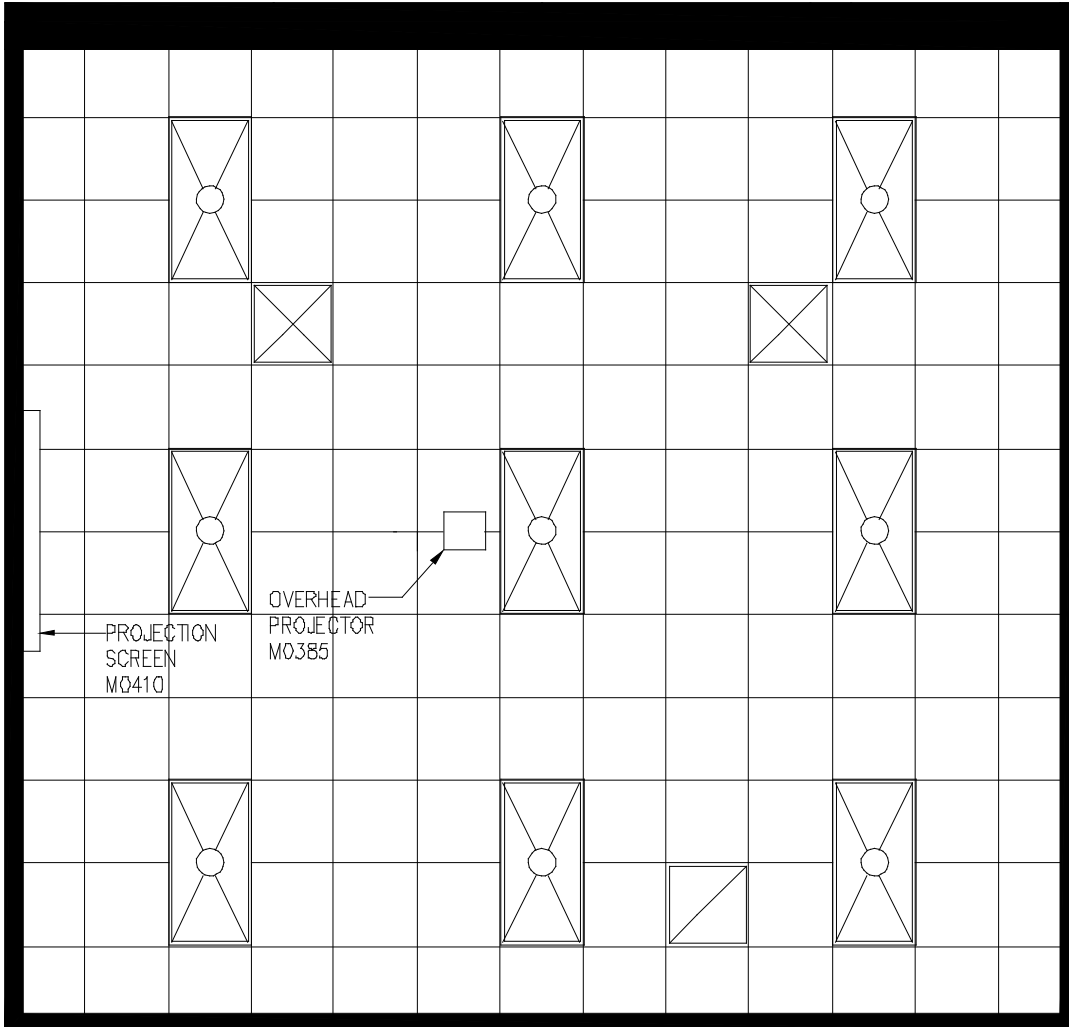
JSN	QUANTITY	AI	DESCRIPTION
			<i>Note: Where VA standard items are shown, non-institutional & sustainable options should be considered if feasible.</i>
A1010	1	CC	TELECOMMUNICATION/DATA OUTLET
A1011	1	CC	TELEPHONE, 1 LINE
A6046	AR	VV	ARTWORK, DECORATIVE WITH FRAME (NOT SHOWN)
F0115	AR	VV	BOOKCASE, OPEN 5 SHELF
F0225	AR	VV	CHAIR, DINING ROOM
F0255	AR	VV	CHAIR, EASY 35" HIGH X 28" WIDE X 32" DEEP
F0795	AR	VV	TABLE, DINING 42" DIAMETER ROUND / 42" SQUARE
F2000	AR	VV	WASTE CONTAINER, ROUND, METAL 18" HIGH X 16" DIAMETER
F2305	AR	VV	MAGAZINE RACK, FREESTANDING
F3200	1	VV	CLOCK, BATTERY OPERATED, 305mm (12"dia.)
F3235	1	VV	RACK, HAT/COAT FLOOR STANDING

TABLE 7.7
Social Activities / Dining / Multi-Purpose Room

7.8 Classroom / Group Room (CRA02) - 600 NSF [55.8 NSM] Floor Plan



7.8 Classroom / Group Room (CRA02) - 600 NSF [55.8 NSM] Reflected Ceiling Plan



7.8 Classroom / Group Room (CRA02) - 600 NSF [55.8 NSM]

Function:

This space will be used for a variety of educational programs for participants both with and without family members. This room may or may not have a control room/office adjacent to this space.

Note: Where VA standard items are shown, non-institutional & sustainable options should be considered if feasible.

Space Requirement:

Classroom / Group Room: 600 NSF [55.8 NSM]

Classroom / Group Room

Architectural:

Floor Finish:	Sheet vinyl, linoleum or rubber flooring
Base:	Rubber Base
Wall Finish:	Gypsum Board - Painted
Ceiling:	Acoustic Tile
Ceiling Height:	9'-6" Min.
Noise (STC Rating):	Sound insulation from adjacent spaces critical. Provide STC 40 as a minimum and STC 45 for walls adjacent to group therapy rooms, conference rooms and other classrooms.
Hardware:	VA Hardware Set # 40
Doors:	3'-6" x 7'-0" wood with ½ light glazing if partitions are utilized.
Windows:	Not required. If provided, inside layer of exterior window units shall be laminated glass. Interior glazing shall be laminated glass. Integral blinds for sun control are preferred but not required

Mechanical:

Inside Design Condition:	70 degrees F (21C) to 75 degrees F (24C) year round 30% -50% Relative Humidity
Min. Air Supply Air Change/Hr:	6
Return Air:	Permitted
Exhaust Air:	Not Required
Room Noise Level:	NC 35
Individual Temperature Control:	Required
Room Air Balance:	Neutral

Electrical:

Lighting Levels:	
Gen. Illumination:	50 fc
Suppl. Illumination:	Dimmable Fluorescent down lights
Emerg. Illumination:	As required
Emergency Power:	As required
Receptacles:	As required

7.8 Classroom / Group Room (CRA02) - 600 NSF [55.8 NSM]

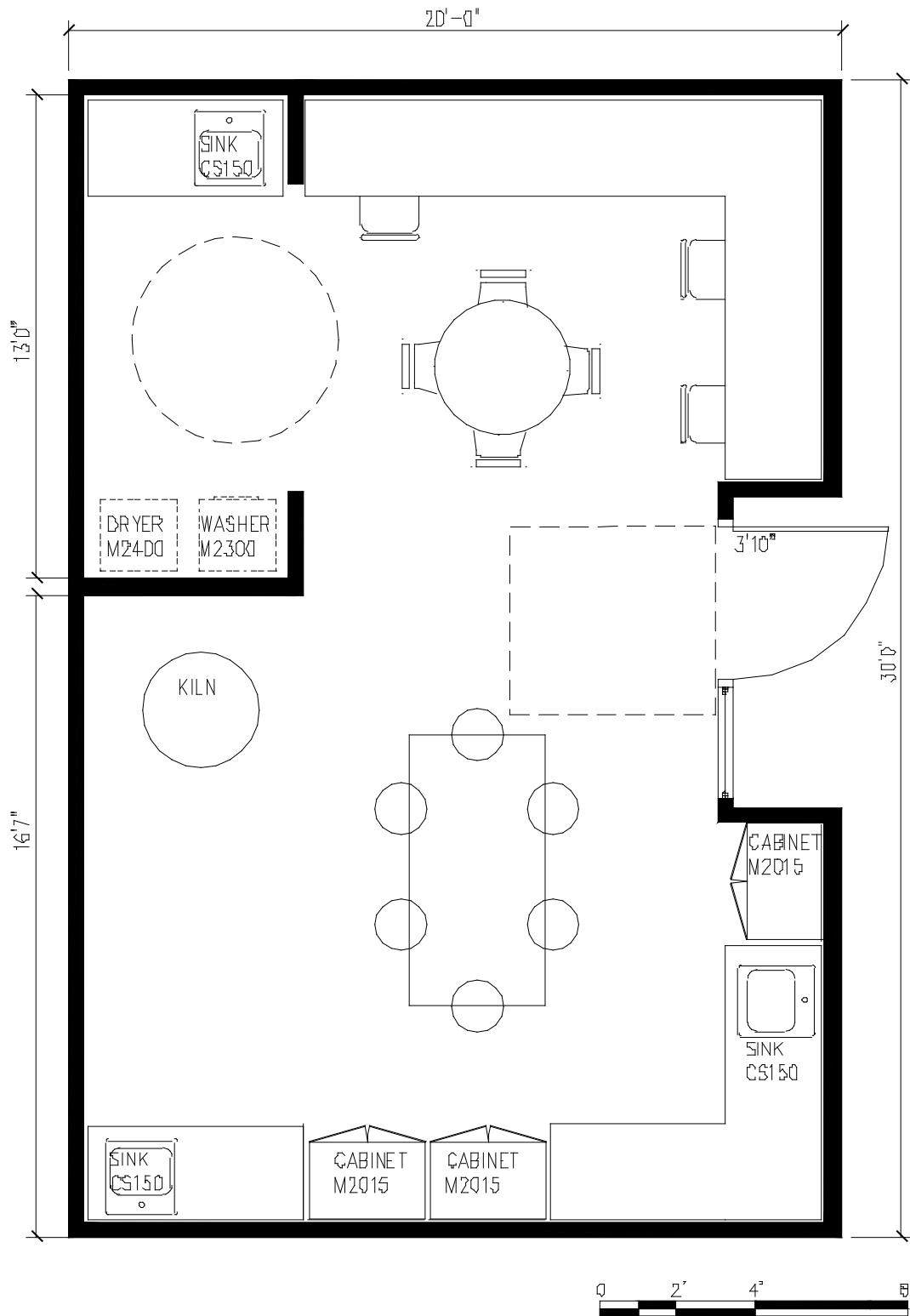
Equipment Table:

See Legend of Symbols in Section 1.6

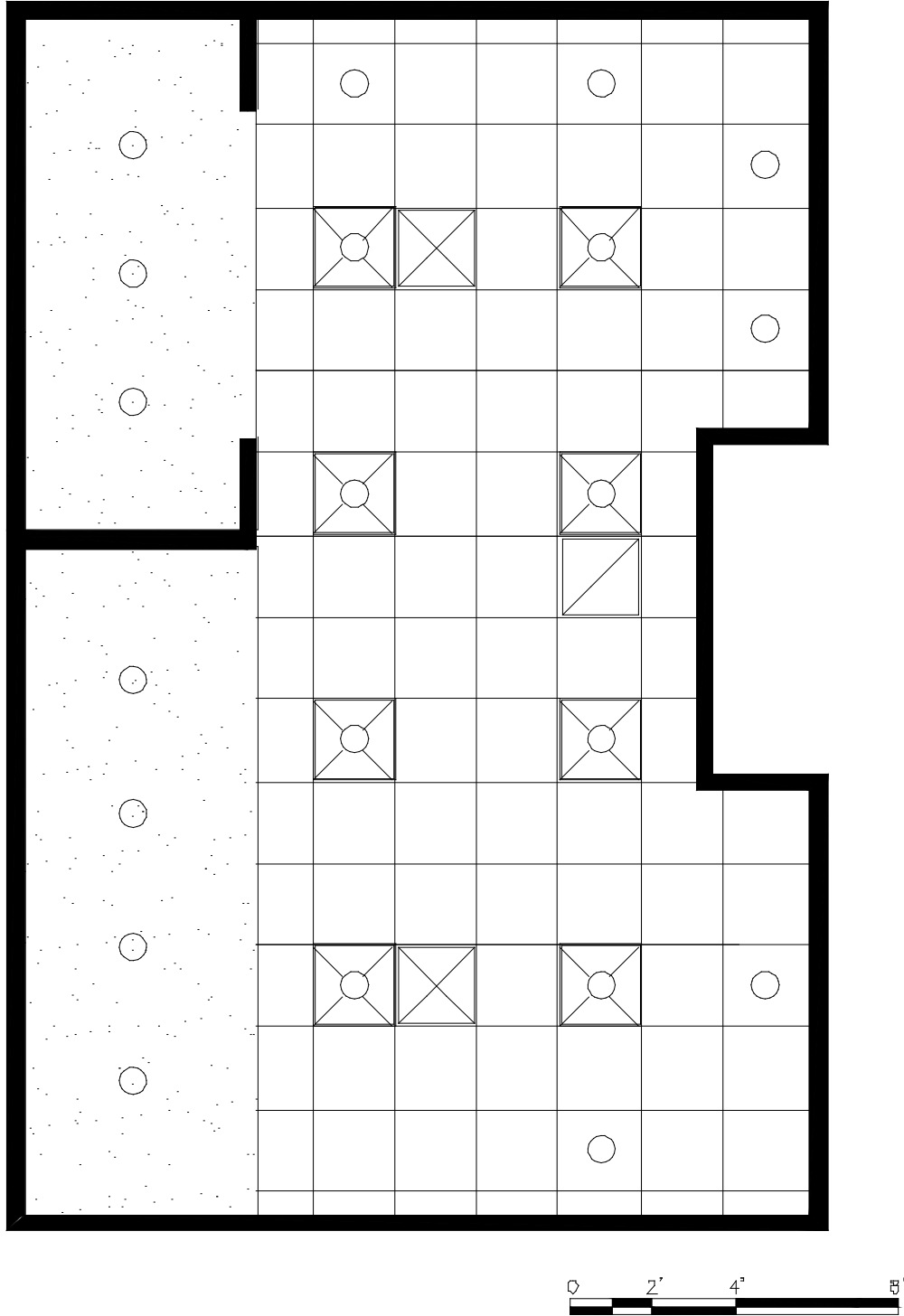
JSN	QUANTITY	AI	DESCRIPTION
			Note: Where VA standard items are shown, non-institutional & sustainable options should be considered if feasible.
JSN A1010	AR	CC	TELECOMMUNICATION/DATA OUTLET (WIRE TO LECTURN)
JSN A1011	1	CC	TELEPHONE, 1 LINE (WIRE TO LECTURN VIA FLOOR MOUNT)
JSN A5145	AR	CC	HOOK, GARMENT, SURFACE MOUNTED
JSN A6046	1	VV	ARTWORK, DECORATIVE WITH FRAME (NOT SHOWN)
JSN F0115	1	VV	BOOKCASE WITH FIVE (5) ADJUSTABLE SHELVES
JSN F0220	AR	VV	CHAIR, CONFERENCE (2) PER TABLE
JSN F0295	AR	VV	CHAIR, STACKING
JSN FO300	1	VV	CHAIR, TASK, SWIVEL WITH ARMS
JSN MO385	1	VV	PROJECTOR, OVERHEAD
JSN M0410	1	CC	SCREEN, PROJECTION, 70" X 70"
	AR	VV	TABLE, SEMINAR DIMENSIONS ARE APPROXIMATELY 30" HIGH, 24" WIDE, 60" LONG
JSN F2100	1	VV	LECTURN, MOBILE WITH READING LIGHT
JSN F3055	1	CC	WHITEBOARD, WITH SLIDING PANELS
JSN F3200	1	VV	CLOCK, BATTERY OPERATED 12" DIAMETER
JSN F2000	1	VV	WASTE CONTAINER, PAPER, ROUND, METAL

TABLE 7.8
Classroom

7.9 Occupational Therapy (OTGC1) – 600 NSF [55.8 NSM] Floor Plan



7.9 Occupational Therapy (OTGC1) – 600 NSF [55.8 NSM] Reflected Ceiling Plan



7.9 Occupational Therapy (OTGC1) – 600 NSF [55.8 NSM]

Function: This space is used for occupational and art therapy. A separate teaching kitchen will be used for food preparation and nutrition instruction. Specific activities in this space need to be confirmed on a project by project basis as a part of the programming process.

Note: Where VA standard items are shown, non-institutional & sustainable options should be considered if feasible.

Space Requirement:

Occupational Therapy: 600 NSF [55.8 NSM]

Architectural:

Floor Finish:	Sheet vinyl, linoleum or rubber flooring. Ceramic tile in kiln area
Base:	Rubber Base
Wall Finish:	Gypsum Board – Painted; Ceramic tile in kiln area
Ceiling:	Acoustic Tile
Ceiling Height:	9'-6" Min.
Noise (STC Rating):	Sound insulation from adjacent spaces critical. Provide STC 40 as a minimum and STC 45 for walls adjacent to group therapy rooms, conference rooms and other classrooms.
Hardware:	VA Hardware Set # 40
Doors:	3'-6" x 7'-0" wood with ½ light glazing if partitions are utilized.
Windows:	Not required. If provided, inside layer of exterior window units shall be laminated glass. Interior glazing shall be laminated glass. Integral blinds for sun control are preferred but not required

Mechanical:

Inside Design Condition:	70 degrees F (21C) to 75 degrees F (24C) year round 30% -50% Relative Humidity
Min. Air Supply Air Change/Hr:	6
Return Air:	Permitted
Exhaust Air:	Provide if a kiln is used in this area.
Room Noise Level:	NC 35
Individual Temperature Control:	Required
Room Air Balance:	Neutral.

Electrical:

Lighting Levels:	
Gen. Illumination:	30 fc
Emerg. Illumination:	As required
Emergency Power:	As required
Receptacles:	As required

7.9 Occupational Therapy (OTGC1) – 600 NSF [55.8 NSM]

Equipment Table:

SYMBOL	QUANTITY	AI	DESCRIPTION
			<i>Note: Where VA standard items are shown, non-institutional & sustainable options should be considered if feasible.</i>
A1010	1	CC	TELECOMMUNICATION/DATA OUTLET
JSN A1011	1	CC	TELEPHONE, 1 LINE
M2300	1	VV	WASHER, RESIDENTIAL MODEL
M2400	1	VV	DRYER, RESIDENTIAL MODEL
NO JSN	1	VV	KILN, POTTERY
M2015	AR	VV	STORAGE CABINET- 36" X 84" X 24" LOCKABLE WITH ADJUSTABLE SHELVING
C5150	1	CC	SINK, STAINLESS STEEL, SINGLE COMPARTMENT

TABLE 7.9
Occupational Therapy

(This page intentionally left blank)

Department of
Veterans Affairs

Memorandum

Date: DEC 30 2010
From: Acting Director, Office of Construction & Facilities Management (00CFM)
Subj: New Mental Health Design Guide
To: Under Secretary for Health (10)

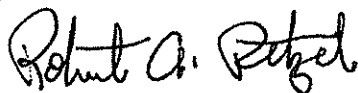
1. The new Mental Health Facilities Design Guide has been completed. This document will be available on the Office of Construction and Facilities Management (CFM) Technical Information Library (TIL) website at <http://www.cfm.va.gov/til/>. A hard copy of the document is attached.
2. The new Design Guide is intended to provide tools for a project team to use as a basis and framework for the planning and design of mental health projects. This document has been produced with intensive input from your office, as well as from expert consultants, and CFM. We have incorporated a large body of data, information, and comments in this guide.
3. This is a dynamic document and we will be incorporating periodic changes as needed and rewriting the document every 3-5 years.
4. The document has been reviewed and concurred by Dr. Antonette Zeiss, Acting Deputy Chief Consultant, Mental Health Services.
5. To formally complete this hallmark effort, we ask for your concurrence.
6. Many thanks for your staff's important assistance in developing these standards for planning, design, and construction of state-of-the-art facilities supporting world class health care for our Nation's Veterans. Please do not hesitate to contact me if you have questions or comments.



Robert L. Neary, Jr.

Attachment

Concur Non Concur



Under Secretary for Health (10)

DEC 30 2010

DATE