

Patient Safety Standards, Materials and Systems Guidelines

Recommended by the
New York State Office of Mental Health

With respect to NYS-OMH operated facilities, these Guidelines apply solely to new construction and major renovation projects. Existing facilities should use these Guidelines as a reference document whenever they make improvements.



Patient Safety Standards, Materials and Systems Guidelines

Recommended by the
New York State Office of Mental Health



Office of
Mental Health

Table of Contents

* All products are not appropriate for all applications. Please read the introductory language on page 3 prior to proceeding.

Introduction <ul style="list-style-type: none">PurposeApproachConventional PracticeCurrent Best PracticeRisk ManagementRisk Assessment - Service providers shall perform prior to utilizing this standardNomenclature & ApplicabilityProduct Evaluation Process	Division 08 Openings (Continued) <ul style="list-style-type: none">Exterior WindowsDoors, Secure Wood DoorAccess Doors Division 09 Finishes <ul style="list-style-type: none">Wall Assemblies, GeneralCeiling Assemblies, GeneralWall BaseCeilings Division 10 Specialties <ul style="list-style-type: none">Shower & Privacy Curtain Track SystemCloset Rods, Clothes & Towel HooksHandrails & Grab Bars, GeneralHandrailsWall ProtectionToilet Accessories, Grab BarsToilet Accessories, GeneralToilet Accessories, Soap DispensersToilet Accessories, Paper Towel Holders & DispensersToilet Accessories, Hand DryersToilet Accessories, Toilet Tissue Holders & DispensersToilet Accessories, MirrorsWindow TreatmentsArtwork FramesCabinet HardwareSignageFire Extinguisher CabinetsWall Device Covers Division 12 Furnishings <ul style="list-style-type: none">Furniture, General Division 21 Fire Suppression <ul style="list-style-type: none">Sprinklers Division 22 Plumbing <ul style="list-style-type: none">Lavatory Assemblies, GeneralLavatory AssembliesLavatory BasinsLavatory Pipe Enclosures	Division 22 Plumbing (Continued) <ul style="list-style-type: none">Lavatory FaucetsLavatory Grid StrainersToilets, GeneralToiletsToilet FlushometersToilet Flush Valve CoversHydration StationsShower HeadsHand ShowersShower Controls & Activators Division 23 HVAC <ul style="list-style-type: none">HVAC, GeneralThermostatsDiffusers & Grilles Division 26 Electrical <ul style="list-style-type: none">Receptacles & Switches, GeneralReceptacles & GFCI/AFCI Circuit BreakersWall PlatesLight Fixtures, GeneralLight Fixtures, Interior, General, Surface-mountedLight Fixtures, Interior, General, RecessedLight Fixtures, Interior, Task LightingLight Fixtures, Interior, Night LightingLight Fixtures, Exit Signage Division 27 Communications <ul style="list-style-type: none">Wireless RoutersClocks Division 28 Electronic Safety & Security <ul style="list-style-type: none">Fire Alarm Components, General
--	---	--

Introduction

Purpose



This document offers guidance with respect to patient safety features in the inpatient psychiatric environments throughout New York State. It grows out of the standards of new construction for the New York State Office of Mental Health's (NYS-OMH) inpatient hospitals in order to provide guidance for:

- Existing and new NYS-OMH state-operated inpatient facilities
- Psychiatric units in NYS-OMH licensed Article 28 general hospitals
- NYS-OMH licensed Article 31 hospitals

This document is not intended to provide guidance for outpatient psychiatric facilities. Generally the risks associated with outpatient facilities may not warrant special environmental precautions.

The purpose of these guidelines is to provide a selection of materials, fixtures, and hardware that the NYS-OMH has reviewed and supports for use within inpatient psychiatric units to further the agency's goal of reducing the risk of harm to individuals in inpatient settings. Utilization of any of these products is not mandatory.

The NYS-OMH would be pleased to evaluate other products identified by hospitals.

Many of the items in this document represent the current state of the art. It is anticipated that additional or more effective products will continue to be developed. The NYS-OMH intends to periodically update these guidelines to keep current with these changes, but the hospitals also have an obligation to continue to review products that will assist in this goal. Please note that due to the nature of ongoing product developments in the market, manufacturers may make modifications to products at any time, without providing notification to NYS-OMH. Please be aware that such modifications may alter the products' ligature resistance evaluations and therefore require further testing to assess risks.

The products and systems included in this document have been tested for patient safety in conformance with OMH testing protocols, but the existing or newly-built environment introduces a unique complexity that must be considered prior to incorporating any of these products. Evaluation of programmatic appropriateness and architectural detailing shall not be omitted from the product selection process. In particular, retrofit conditions must be understood before a product is provided for the facility.

The items selected here represent styles and properties of products that help lower patient risk while on an inpatient psychiatric unit. **However, installation of these products will not eliminate all risks.**

Introduction

Approach

OMH supports a multi-directed approach to the reduction of patient harm on inpatient psychiatric units including the following:

- Completion of a patient risk assessment
- Completion of a physical plant risk assessment
- Ongoing staff training to ensure awareness of potential risks on units
- Installation of products that reduce risk in all patient areas
- Routine inspections of inpatient psychiatric units to ensure safety levels are maintained

Additional and more detailed information on some of the items found in these standards may be available from NYS-OMH.

By providing these guidelines the New York State Office of Mental Health neither endorses nor promotes any product or manufacturer. OMH does not guarantee the performance of any product. OMH recognizes that it is not possible to evaluate all products that are for sale. Under these circumstances it is at NYS-OMH's discretion which products are selected for review.

The absence of any product from the guidelines does not necessarily mean that the product is unsafe or unacceptable for use (refer to the paragraphs that follow). If a health care facility has installed products that were previously recommended in an earlier edition of the Patient Safety Standards (PSS) but are no longer listed in the PSS, it is the responsibility of the health care facility to reassess that product to determine whether its continued use is consistent with that hospital's safety risk assessment policies.

It is crucial that hospital managers complete risk assessments that go beyond the selection of the materials, furnishings, and fixtures found in these Patient Safety Standards. The Facilities Guidelines Institute (FGI), "Guidelines for Design and Construction of Healthcare Facilities" provides clear, detailed direction regarding a hospital's responsibility to be in compliance with patient safety requirements. The sections covering the Safety Risk Assessment (SRA) describe general risk assessment procedures. Refer to the 2018 edition of FGI, which has been adopted by The Joint Commission. Also refer to applicable state regulations which may have adopted alternative editions of the FGI.

Within this larger construct, the selection of products to be used in the built environment is but one component of risk management policies and procedures that every healthcare facility is responsible for developing and maintaining.

Introduction

Conventional Practice prior to NYS-OMH Patient Safety Standards



Focus Above the Waist

The reduction of self harm incidents is often a matter of life or death. Suicide attempts using a ligature (e.g. strangulation) are the most prevalent form of self harm. This was initially addressed in modern hospital design by strongly focusing on the elimination of ligature attachment points that were above the waist line.

Above the Waist Ligature Attachment Points:

- Fasteners
- Door Hinges
- Door Closers
- Windows & Vision Panels
- Access Doors
- Ceiling Systems
- Shower & Privacy Curtains
- Clothes & Towel Hooks
- Closet Bars
- Mirrors
- Toilet Partitions
- Window Treatments
- Bulletin Boards
- Picture Hanging Systems
- Cabinet Hardware
- Sprinklerheads
- Showerheads
- Medical Gas Enclosures
- HVAC Devices & Covers
- Thermostats
- Electrical Receptacles
- Light Fixtures
- Fire Alarm Components

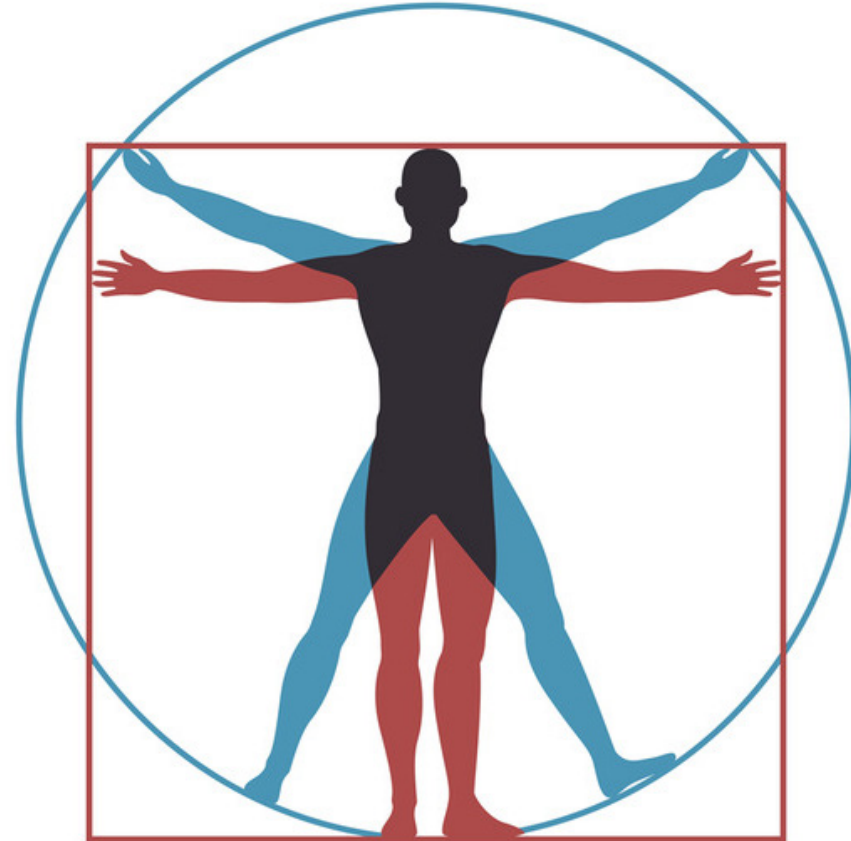

Introduction

Current Best Practice



Focus Everywhere

Today, all psychiatric healthcare facilities, whether new or existing, are required to meet comprehensive accreditation standards to ensure that the risks to patient safety are minimized. Principles that support patient safety strategies avoid systems, assemblies and materials that can be weaponized, yield sharp edges, or provide ligature points in all locations accessible to patients.

Additional Ligature Attachment Points to Consider:

- Door Handles
- Door Bumpers
- Wall Base
- Trim Strips between Assemblies
- Toilet Accessories
- Grab Bars
- Fire Extinguisher & Hose Cabinets
- Furniture
- Lavatories
- Lavatory Faucets
- Valves
- Shower Controls & Activators
- Plumbing Traps & Piping

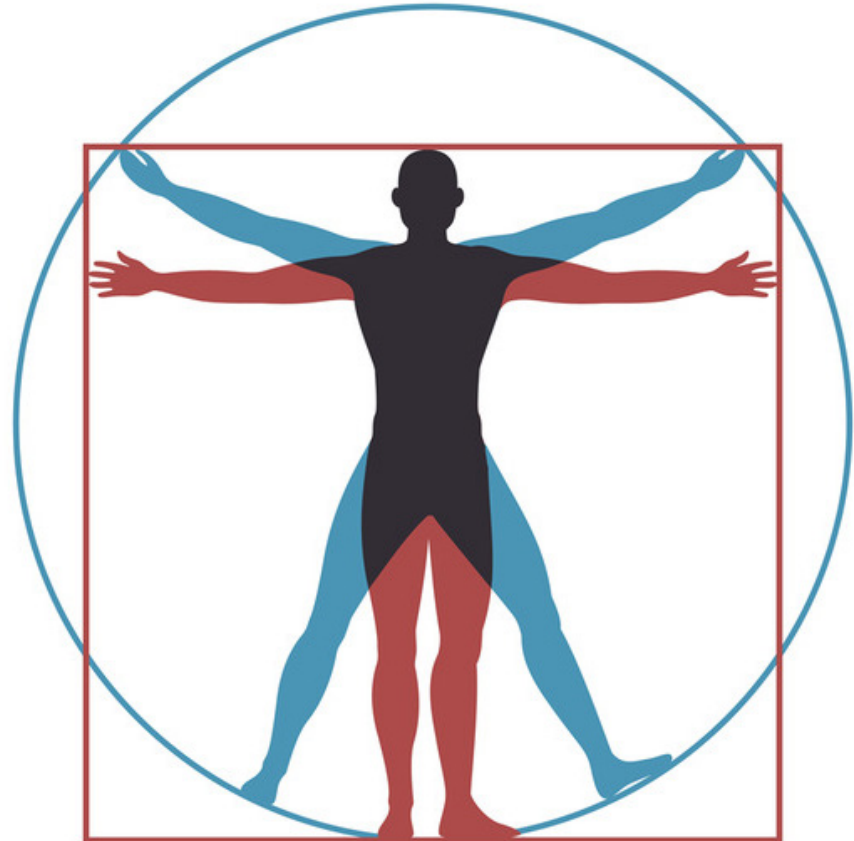

Introduction

Risk Management

Risk Management, Not Risk Elimination
FGI Guidelines for Design and Construction of Hospitals, 2018 Edition, Appendix

A2.5-1.5 Environment of Care

The majority of persons who attempt suicide suffer from a treatable mental disorder or a substance abuse disorder or both. Patients of inpatient psychiatric treatment facilities are considered at high risk for suicide; therefore, the environment should avoid physical hazards while maintaining a therapeutic environment. However, although a safe environment is critical, no environment can be entirely safe and free of risk. The built environment, no matter how well designed and constructed, cannot be relied upon as an absolute preventive measure. Staff awareness of the environment, the latent risks of that environment, and the behavior risks and needs of the patients served in that environment is absolutely essential. Different organizations and different patient populations will require greater or lesser tolerance for risk.

Introduction

Risk Assessment

High Risk approved products are safe for all locations. Though High Risk products may be safe for all areas, they may not be appropriate for all areas. In many cases the High Risk product will look too institutional for the area. Determining an individual room’s risk assignment will depend on a room-by-room Risk Assessment of all areas of the facility which has been conducted specifically for each facility using that hospital or system’s own risk assessment tool. The following are typical groupings of room by risk. Each hospital’s assessment may vary based upon patient profile, staffing, or unit geography.



Typical High Risk Areas

Areas with solitary and/or unsupervised patient use.



Typical Medium Risk Areas

Patient access is controlled, or use is supervised with no solitary and/or unsupervised use.



Typical Low Risk Areas

Staff only areas. No Patient Use.

Introduction

Nomenclature & Applicability

Notes like this on each page will identify additional considerations that are applicable, and also will identify alternative products that are acceptable as minimum standards for Article 31 hospitals, Article 28 hospitals, and state-operated hospitals.



Accepted by OMH

Items with this symbol constitute a best practice for all existing facilities and a minimum standard for new construction and renovation projects at NYS-OMH's state-operated inpatient hospitals. Unless alternatives are identified in the notes section of the page, such items are also minimum standards for Article 31 and Article 28 hospitals.



Under NYS-OMH Evaluation

Items with this symbol are currently being assessed by NYS-OMH for suitability in NYS inpatient psychiatric hospitals or units.



Retrofit

Items with this symbol are not suitable for use in new construction but are acceptable for renovation in NYS inpatient psychiatric hospitals or units.



Use with Caution

Items with this symbol might be suitable for certain inpatient environments; however, they should be used with caution. Some of these items have institutional characteristics that are not appropriate for an environment that is certified by the Joint Commission, which requires non-institutional fittings and fixtures. Others items have inherent risks that must be evaluated for their appropriateness for the intended application. Typically, the associated notes describe why the device is to be used with caution.



NYS-OMH Rejected

Items with this symbol are unsuitable for use in new construction or renovation in NYS inpatient psychiatric hospitals or units.



Paper Clip Resistant

Items with this symbol have withstood paper clip testing in addition to all other applicable testing methods.

Introduction

Product Evaluation Process

NYS-OMH evaluates products for inclusion into its Patient Safety Standards using a variety of criteria. These criteria fall into two categories; Primary Criteria and Secondary Criteria.

Primary Criteria

- Ligature Resistance: Looping
- Ligature Resistance: Wedging
- Cutting
- Jumping
- Tamper Resistance
- Weaponization
- Contraband Storage
- PICA/Ingestion

Secondary Criteria

- Ligature Resistance by combining a ligature with other readily available objects
- Ligature Resistance that is the result of the configuration in which a product is installed
- Codes & Regulations
- Therapeutic Environment & Appearance
- Constructibility
- Durability
- Maintenance

The presence of paper clips in even the most rigorously monitored inpatient environment is difficult to control. Because paper clips may be available to patients, tests for product inclusion in the OMH Patient Safety Standards include an attempt to utilize paper clips in concert with other objects to develop ligature on tested items. It should be assumed that almost anything in the patient environment can be compromised by a paper clip; for those items that withstand the ligature testing with use of paper clips, a product may be accepted by OMH and receive a special notation indicating that it has withstood such testing methods. The symbol  indicates a product withstanding paper clip testing in addition to all other applicable methods of testing and is appropriate for use in high risk areas.

As is written on page 4 of this document, a much more comprehensive assessment of risk in the patient environment is always necessary in order to meet the spirit of the Patient Safety Standard recommendations.

The availability of safe products for the inpatient environment is a growing and evolving market. New products are routinely introduced by manufacturers. Products that were once accepted by NYS-OMH in previous versions of the Patient Safety Standard may be rejected or phased out in future versions in light of new products or new knowledge about their risks. For more information about the NYS-OMH Product Evaluation Process, contact NYS-OMH.

Anti-Barricade Strategies

An unintended consequence of providing more patient privacy is the increased opportunity for a patient to use a door as a barricade. Solutions range from direct penetration of the door by force to using advanced door systems that can be opened outward in an emergency situation. The direct solution is more economical at first, but will require replacement of the door. The advanced door technology does not harm the door, but may increase the initial construction cost. Each anti-barricade strategy has conditions, limitations, and/or risks associated with them that should be carefully considered. The options listed below span this continuum.

ANTI-BARRICADE STRATEGIES	DESCRIPTION OF EMERGENCY OPERATION	DOOR TYPE	RELATIVE COST	REVERSABILITY	FIRE/ SMOKE RATABLE	ACOUSTIC & VISUAL PRIVACY	COMMENTS
1 Standard in-swinging door without additional anti-barricade features	Use of Jaws of Life, wrecking bar or other method to remove door.	All Types	Low	No	Yes/Yes	Yes/Yes	Risk of injury. Requires stock replacement doors and significant labor. This strategy is not acceptable for bathroom doors per FGI.
2 Out-swinging Doors	Door can be opened from outside room. However, it may compromise path of egress.	All Types	Low	Yes	Yes/Yes	Yes/Yes	Risk of injury. Requires wide corridors or deep niches at entries with risk of reduced visibility. Not recommended.
3 Double-Swinging (DS) Doors with propriety emergency stop or continuous swing-away stops	Use of a key/tool to retract/swing-away the door stop at the latch side, permitting door leaf to swing outward.	All Types	Medium	Yes	No/Yes	Yes/Yes	Privacy mitigation is required with use of conventional hospital stops. Use of non-keyed stops is not recommended. Note NFPA tolerances for fire and smoke rating. Door edge strength is critical with the use of emergency stops. Consider multiple stops if not using a continuous stop. Conventional hospital stops allow anyone to override them to gain access.
4 Double-Swinging (DS) Doors with Removable Stop	Provide removable hollow metal/aluminum stops fixed to frame with tamper-resistant fasteners.	All Types	Low	Yes	Yes/Yes	Yes/Yes	Requires removal of stops to open door into corridor.
5 In-swinging Door with Removable Frame or Split Frame	Door and split frame can be detached from outside room.	All Types	Medium	Yes	Possible	Yes/Yes	Research needed to develop and test prototype.
6 Door within a Door (Wicket) with Concealed Hinges	Allows secondary access through inset wicket door.	Wood	High	Yes	No/Yes	Yes/Yes	Non-normative. Meets smoke requirements but may not meet fire ratings due to its design. Manufacturing and installation tolerances may result in a wedgeable gap between door leaf and wicket leaf.
7 Secondary Door in Sidelite Frame	Provide secondary access through door in sidelite frame.	All Types	High	Yes	Yes/Yes	Yes/Yes	Requires out-swinging door in adjacent sidelite opening in hollow metal frame.
8 Double Leaf Door with Inactive Leaf	Recessed throw bolts; top and bottom, activator on corridor face of door.	All Types	High	Yes	Yes/Yes	Yes/Yes	Provide keyed bolts at top and bottom of inactive leaf. Privacy mitigation required. Provide compressible material at strike edge. Pay attention to NFPA tolerances for fire and smoke rating. Reinforce bottom of active rescue leaf at recessed floor bolt.
9 Swinging, Non-latching Door	PVC door or upholstered foam door with continuous or magnetic hinge.	Varies	Low	Yes	No/No	No/Yes	Suitable for en-Suite Bathrooms only.
10 Ligature Resistant Sliding Door	Flush door leaf hung from concealed track hardware.	All Types	High	No	No/No	Yes/Yes	Suitable for en-Suite Bathrooms only.
11 Out-swinging or Double-Swinging Bathroom Door with Roller Latch	Recessed pull with roller latch strike.	All Types	Medium	Yes	No/No	Yes/Yes	Suitable for en-Suite Bathrooms only.
12 No-Door Leaf	Door frame prepped for no door leaf.	NA	Low	NA	No/No	No/No	Suitable for en-Suite Bathrooms only.

Anti-Barricade Strategies

ANTI-BARRICADE STRATEGIES	
1	Standard in-swinging door without additional anti-barricade features
2	Out-swinging Doors
3	Double-Swinging (DS) Doors with propriety emergency stop or continuous swing-away stops
4	Double-Swinging (DS) Doors with Removable Stop
5	In-swinging Door with Removable Frame or Split Frame
6	Door within a Door (Wicket) with Concealed Hinges
7	Secondary Door in Sidelite Frame
8	Double Leaf Door with Inactive Leaf
9	Swinging, Non-latching Door
10	Ligature Resistant Sliding Door
11	Out-swinging or Double- Swinging Bathroom Door with Roller Latch
12	No-Door Leaf



Kingsway Group

www.kingswaygroupusa.com

SWITCH Anti-Barricade Door System

Double action anti-barricade door system includes hollow metal frame with single rabbeted latching jamb, solid core wood door, lockset/handle, and KG280 switch hinge system. UL1784 rated for smoke leakage.

Optional accessory:

KG35 Double Action Transom Closer

Fully recessed closer available for use with the Kingsway SWITCH Anti-Barricade Door System. Closer is double-acting

Caution: Anti-barricade functionality may be compromised by exerting force on the double-action hinge from inside the room.



SWITCH Anti-Barricade Door System



KG35 Double Action Transom Closer

Anti-Barricade Hardware | Code Notes

For corridor doors, verify Life Safety Code requirements to limit passage of smoke. Specify appropriate gap tolerances at top and jambs.

Anti-Barricade Hardware | Constructibility Notes

- Coordinate backset of lockset/handle when providing swing/emergency stops to avoid handle/stop operational conflict.
- Refer to manufacturer's data when using removable stops in fire rated assemblies.
- Coordination between door opening width, hinge width, and door panel width is required.

Cautions:

- **All hinges inherently carry risk due to multiple joints between moving parts, and extremely low acceptable tolerances. Consistent quality in manufacturing may be difficult to achieve and should be inspected in the field.**

Anti-Barricade Strategies

ANTI-BARRICADE STRATEGIES	
1	Standard in-swinging door without additional anti-barricade features
2	Out-swinging Doors
3	Double-Swinging (DS) Doors with propriety emergency stop or continuous swing-away stops
4	Double-Swinging (DS) Doors with Removable Stop
5	In-swinging Door with Removable Frame or Split Frame
6	Door within a Door (Wicket) with Concealed Hinges
7	Secondary Door in Sidelite Frame
8	Double Leaf Door with Inactive Leaf
9	Swinging, Non-latching Door
10	Ligature Resistant Sliding Door
11	Out-swinging or Double- Swinging Bathroom Door with Roller Latch
12	No-Door Leaf



Safehinge Primera, Inc.

www.safehingeprimera.com

Swiftstop Anti-Barricade Doorset

Double action anti-barricade door system includes hollow metal frame with latching jamb, wood solid core door, lockset/trim, hinge. Single tool used to operate the vision panel and the collapsible stop.

Optional accessories include:

- Vision panel
- Concealed door closer
- Full door ligature alarm system.



Sureview Vision Panel



Sureclose Concealed Door Closer



Full Door Ligature Alarm System

Anti-Barricade Hardware | Code Notes

For corridor doors, verify Life Safety Code requirements to limit passage of smoke. Specify appropriate gap tolerances at top and jambs.

Anti-Barricade Hardware | Constructibility Notes

- Coordinate backset of lockset/handle when providing swing/emergency stops to avoid handle/stop operational conflict.
- Refer to manufacturer's data when using removable stops in fire rated assemblies.
- Coordination between door opening width, hinge width, and door panel width is required.

Cautions:

- **All hinges inherently carry risk due to multiple joints between moving parts, and extremely low acceptable tolerances. Consistent quality in manufacturing may be difficult to achieve and should be inspected in the field.**



Accurate Lock & Hardware

www.accuratelockandhardware.com

Keyed Emergency Stop ADL-CEK, ADL-OEK

Double lip strikes with keyed emergency stop. Designed to restrict and protect against unauthorized outswinging door by using a key to lock stop in projected position.

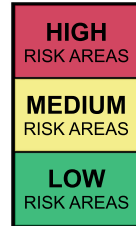

ANTI-BARRICADE STRATEGIES	
1	Standard in-swinging door without additional anti-barricade features
2	Out-swinging Doors
3	Double-Swinging (DS) Doors with propriety emergency stop or continuous swing-away stops
4	Double-Swinging (DS) Doors with Removable Stop
5	In-swinging Door with Removable Frame or Split Frame
6	Door within a Door (Wicket) with Concealed Hinges
7	Secondary Door in Sidelite Frame
8	Double Leaf Door with Inactive Leaf
9	Swinging, Non-latching Door
10	Ligature Resistant Sliding Door
11	Out-swinging or Double- Swinging Bathroom Door with Roller Latch
12	No-Door Leaf

Anti-Barricade Hardware | Code Notes

For corridor doors, verify Life Safety Code requirements to limit passage of smoke. Specify appropriate gap tolerances at top and jams.

Anti-Barricade Hardware | Constructibility Notes

- Coordinate backset of lockset/handle when providing swing/emergency stops to avoid handle/stop operational conflict.
- Refer to manufacturer's data when using removable stops in fire rated assemblies.
- Coordination between door opening width, hinge width, and door panel width is required.

Cautions:

- **A non-locking emergency stop may allow patients to depress the stop and swing the door in the opposite direction. Overpronation of the door in this direction has, in some instances, resulted in patients breaking the door.**
- **Small emergency stops that concentrate the door closing pressure on a small surface area have been known to result in breakage of structural composite lumber doors when doors are slammed by patients.**
- **In-situ evaluation reveals that the use of a single locking point on the rescue stop does not adequately secure the stop when a door is being subjected to abuse (i.e. being repeatedly slammed). It is recommended that at least two locking points be provided: one at the top 1/3 point along the height of the door and one at the bottom 1/3 point along the height of the door to better distribute the force of the slamming along the door stile.**

Anti-Barricade Strategies

ANTI-BARRICADE STRATEGIES	
1	Standard in-swinging door without additional anti-barricade features
2	Out-swinging Doors
3	Double-Swinging (DS) Doors with propriety emergency stop or continuous swing-away stops
4	Double-Swinging (DS) Doors with Removable Stop
5	In-swinging Door with Removable Frame or Split Frame
6	Door within a Door (Wicket) with Concealed Hinges
7	Secondary Door in Sidelite Frame
8	Double Leaf Door with Inactive Leaf
9	Swinging, Non-latching Door
10	Ligature Resistant Sliding Door
11	Out-swinging or Double- Swinging Bathroom Door with Roller Latch
12	No-Door Leaf



Intastop
www.intastop.com

SECURA Stop Multi-lock Removable Doorstop



Pemko
www.pemko.com

Emergency Release Stop (ERS)

Pemko Emergency Release Stop provides emergency outward opening operation of doors that normally open inwards. The door stop has a single point lock at the top. The stop is unlocked by a special tool and swings open with an integral grab handle. The stop hinge has a hospital tip.



Anti-Barricade Hardware | Code Notes

For corridor doors, verify Life Safety Code requirements to limit passage of smoke. Specify appropriate gap tolerances at top and jams.

Anti-Barricade Hardware | Constructibility Notes

- Coordinate backset of lockset/handle when providing swing/emergency stops to avoid handle/stop operational conflict.
- Refer to manufacturer's data when using removable stops in fire rated assemblies.
- Coordination between door opening width, hinge width, and door panel width is required.

Cautions:

- **A non-locking emergency stop may allow patients to depress the stop and swing the door in the opposite direction. Overpronation of the door in this direction has, in some instances, resulted in patients breaking the door.**
- **Small emergency stops that concentrate the door closing pressure on a small surface area have been known to result in breakage of structural composite lumber doors when doors are slammed by patients.**
- **In-situ evaluation reveals that the use of a single locking point on the rescue stop does not adequately secure the stop when a door is being subjected to abuse (i.e. being repeatedly slammed). It is recommended that at least two locking points be provided: one at the top 1/3 point along the height of the door and one at the bottom 1/3 point along the height of the door to better distribute the force of the slamming along the door stile.**

Anti-Barricade Strategies

ANTI-BARRICADE STRATEGIES	
1	Standard in-swinging door without additional anti-barricade features
2	Out-swinging Doors
3	Double-Swinging (DS) Doors with propriety emergency stop or continuous swing-away stops
4	Double-Swinging (DS) Doors with Removable Stop
5	In-swinging Door with Removable Frame or Split Frame
6	Door within a Door (Wicket) with Concealed Hinges
7	Secondary Door in Sidelite Frame
8	Double Leaf Door with Inactive Leaf
9	Swinging, Non-latching Door
10	Ligature Resistant Sliding Door
11	Out-swinging or Double- Swinging Bathroom Door with Roller Latch
12	No-Door Leaf



ABH Manufacturing Inc.

www.abhmfg.com

A507 Double Swing Hinge (Barrel Style)

Available with and without an alarm at the top of the hinge.



Markar Architectural Products

www.markar.com

Double Swing Hinge DSH1000 (Barrel-Style)



Anti-Barricade Hardware | Code Notes

For corridor doors, verify Life Safety Code requirements to limit passage of smoke. Specify appropriate gap tolerances at top and jambs.

Anti-Barricade Hardware | Constructibility Notes

- Coordinate backset of lockset/handle when providing swing/emergency stops to avoid handle/stop operational conflict.
- Refer to manufacturer's data when using removable stops in fire rated assemblies.
- Coordination between door opening width, hinge width, and door panel width is required.

Cautions:

- **A non-locking emergency stop may allow patients to depress the stop and swing the door in the opposite direction. Overpronation of the door in this direction has, in some instances, resulted in patients breaking the door.**
- **Small emergency stops that concentrate the door closing pressure on a small surface area have been known to result in breakage of structural composite lumber doors when doors are slammed by patients.**
- **In-situ evaluation reveals that the use of a single locking point on the rescue stop does not adequately secure the stop when a door is being subjected to abuse (i.e. being repeatedly slammed). It is recommended that at least two locking points be provided: one at the top 1/3 point along the height of the door and one at the bottom 1/3 point along the height of the door to better distribute the force of the slamming along the door stile.**

Anti-Barricade Strategies

ANTI-BARRICADE STRATEGIES	
1	Standard in-swinging door without additional anti-barricade features
2	Out-swinging Doors
3	Double-Swinging (DS) Doors with propriety emergency stop or continuous swing-away stops
4	Double-Swinging (DS) Doors with Removable Stop
5	In-swinging Door with Removable Frame or Split Frame
6	Door within a Door (Wicket) with Concealed Hinges
7	Secondary Door in Sidelite Frame
8	Double Leaf Door with Inactive Leaf
9	Swinging, Non-latching Door
10	Ligature Resistant Sliding Door
11	Out-swinging or Double- Swinging Bathroom Door with Roller Latch
12	No-Door Leaf



Kingsway Group

www.kingswaygroupusa.com

Anti-Ligature Swing Stop
KG 205/206 Anti-Barricade Door Stop, Hardwood
KG 207/208 Anti-Barricade Door Stop, Aluminum

Note: This product is available only as part of a complete door, frame, and hardware assembly and is Under Evaluation until full assembly can be reviewed.



Kingsway Group

www.kingswaygroupusa.com

Swing Hinge
KG202

Note: This product is available only as part of a complete door, frame, and hardware assembly and is Under Evaluation until full assembly can be reviewed.

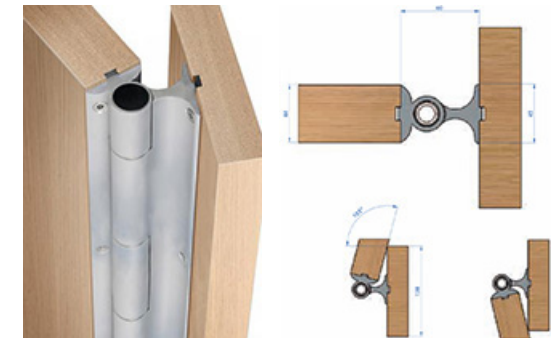

Anti-Barricade Hardware | Code Notes

For corridor doors, verify Life Safety Code requirements to limit passage of smoke. Specify appropriate gap tolerances at top and jambs.

Anti-Barricade Hardware | Constructibility Notes

- Coordinate backset of lockset/handle when providing swing/emergency stops to avoid handle/stop operational conflict.
- Refer to manufacturer's data when using removable stops in fire rated assemblies.
- Coordination between door opening width, hinge width, and door panel width is required.

Cautions:

- **All hinges inherently carry risk due to multiple joints between moving parts, and extremely low acceptable tolerances. Consistent quality in manufacturing may be difficult to achieve and should be inspected in the field.**



Pemko

www.pemko.com

Double Swing Hinge DSHP01 (Geared-Style)



Anti-Barricade Hardware | Code Notes

For corridor doors, verify Life Safety Code requirements to limit passage of smoke. Specify appropriate gap tolerances at top and jambs.

Anti-Barricade Hardware | Constructibility Notes

- Coordinate backset of lockset/handle when providing swing/emergency stops to avoid handle/stop operational conflict.
- Refer to manufacturer's data when using removable stops in fire rated assemblies.
- Coordination between door opening width, hinge width, and door panel width is required.

Cautions:

- **All hinges inherently carry risk due to multiple joints between moving parts, and extremely low acceptable tolerances. Consistent quality in manufacturing may be difficult to achieve and should be inspected in the field.**

ANTI-BARRICADE STRATEGIES	
1	Standard in-swinging door without additional anti-barricade features
2	Out-swinging Doors
3	Double-Swinging (DS) Doors with propriety emergency stop or continuous swing-away stops
4	Double-Swinging (DS) Doors with Removable Stop
5	In-swinging Door with Removable Frame or Split Frame
6	Door within a Door (Wicket) with Concealed Hinges
7	Secondary Door in Sidelite Frame
8	Double Leaf Door with Inactive Leaf
9	Swinging, Non-latching Door
10	Ligature Resistant Sliding Door
11	Out-swinging or Double- Swinging Bathroom Door with Roller Latch
12	No-Door Leaf

Anti-Barricade Strategies

ANTI-BARRICADE STRATEGIES	
1	Standard in-swinging door without additional anti-barricade features
2	Out-swinging Doors
3	Double-Swinging (DS) Doors with propriety emergency stop or continuous swing-away stops
4	Double-Swinging (DS) Doors with Removable Stop
5	In-swinging Door with Removable Frame or Split Frame
6	Door within a Door (Wicket) with Concealed Hinges
7	Secondary Door in Sidelite Frame
8	Double Leaf Door with Inactive Leaf
9	Swinging, Non-latching Door
10	Ligature Resistant Sliding Door
11	Out-swinging or Double- Swinging Bathroom Door with Roller Latch
12	No-Door Leaf



Royde & Tucker Ltd.

www.ratman.co.uk

Emergency Stop H131-105

The release device can be depressed to allow the door to open outward and allow access to the room.

Note: Allows for wedging ligature.

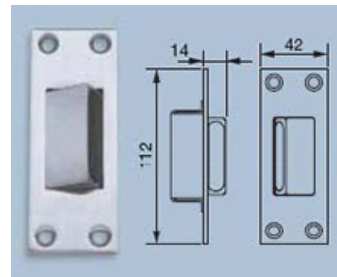

McKinney

www.mckinneyhinge.com

DS-6 Emergency Stop

The release device can be depressed to allow the door to open outward and allow access to the room.

Note: Allows for wedging ligature.

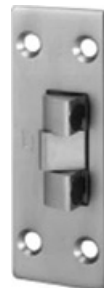

Laidlaw

www.laidlawdirect.com

Swing Away Stop

Note: Potential for looping with this hardware. Stop is not continuous and creates a ligature point.

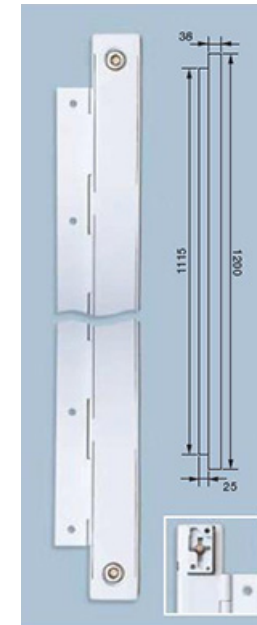

Anti-Barricade Strategies



ANTI-BARRICADE STRATEGIES	
1	Standard in-swinging door without additional anti-barricade features
2	Out-swinging Doors
3	Double-Swinging (DS) Doors with propriety emergency stop or continuous swing-away stops
4	Double-Swinging (DS) Doors with Removable Stop
5	In-swinging Door with Removable Frame or Split Frame
6	Door within a Door (Wicket) with Concealed Hinges
7	Secondary Door in Sidelite Frame
8	Double Leaf Door with Inactive Leaf
9	Swinging, Non-latching Door
10	Ligature Resistant Sliding Door
11	Out-swinging or Double- Swinging Bathroom Door with Roller Latch
12	No-Door Leaf

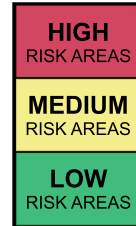

Alternate Removable Stop

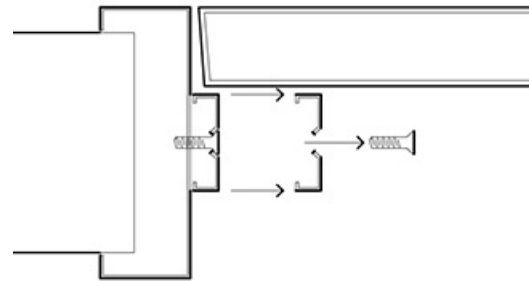

Anti-Barricade Hardware | Code Notes

For corridor doors, verify Life Safety Code requirements to limit passage of smoke. Specify appropriate gap tolerances at top and jambs.

Anti-Barricade Hardware | Constructibility Notes

- Refer to manufacturer's data when using removable stops in fire rated assemblies.
- Coordination between door opening width, hinge width, and door panel width is required.



ANTI-BARRICADE STRATEGIES	
1	Standard in-swinging door without additional anti-barricade features
2	Out-swinging Doors
3	Double-Swinging (DS) Doors with propriety emergency stop or continuous swing-away stops
4	Double-Swinging (DS) Doors with Removable Stop
5	In-swinging Door with Removable Frame or Split Frame
6	Door within a Door (Wicket) with Concealed Hinges
7	Secondary Door in Sidelite Frame
8	Double Leaf Door with Inactive Leaf
9	Swinging, Non-latching Door
10	Ligature Resistant Sliding Door
11	Out-swinging or Double- Swinging Bathroom Door with Roller Latch
12	No-Door Leaf

Ceco Door

www.cecodoor.com

Behavioral Healthcare Patient Room Access Door

Hollow metal construction

Curries

www.curries.com

Behavioral Healthcare Patient Room Access Door

Hollow metal construction

Fleming Door Products

www.flemingdoor.com

Behavioral Healthcare Patient Room Access Door

Hollow metal construction



Anti-Barricade Hardware | General Notes

Primary door requires continuous hinges with hospital tips. Edge bevel may need to be increased. Edge strip shall be securely fastened.

Anti-Barricade Hardware | Code Notes

- Manufacturer must verify the fire rating of the door.
- For corridor doors, verify Life Safety Code requirements to limit passage of smoke. Specify appropriate gap tolerances at top and jambs.

Anti-Barricade Hardware | Constructibility Notes

- Coordination between door opening width, hinge width, and door panel width is required.
- Manufacturing and installation tolerances may result in a wedgeable gap between door leaf and wicket leaf.

Caution

All hinges inherently carry risk due to multiple joints between moving parts, and extremely low acceptable tolerances. Consistent quality in manufacturing may be difficult to achieve and should be inspected in the field.



Construction Specialties

www.c-sgroup.com

Wicket Door

Acrovyn Barrier Resistant Door

Bonded SCL core 5-ply construction.

Note: OMH does not promote the use of plastic clad laminate doors.



Anti-Barricade Hardware | General Notes

Primary door requires continuous hinges with hospital tips. Edge bevel may need to be increased. Edge strip shall be securely fastened. Coordinate fastening/adhering laminate at edge of mortise.

Anti-Barricade Hardware | Code Notes

- Manufacturer must verify the fire rating of the door.
- For corridor doors, verify Life Safety Code requirements to limit passage of smoke. Specify appropriate gap tolerances at top and jambs.

Anti-Barricade Hardware | Constructibility Notes

- Coordination between door opening width, hinge width, and door panel width is required.
- Manufacturing and installation tolerances may result in a wedgeable gap between door leaf and wicket leaf.

Caution

All hinges inherently carry risk due to multiple joints between moving parts, and extremely low acceptable tolerances. Consistent quality in manufacturing may be difficult to achieve and should be inspected in the field.

ANTI-BARRICADE STRATEGIES	
1	Standard in-swinging door without additional anti-barricade features
2	Out-swinging Doors
3	Double-Swinging (DS) Doors with propriety emergency stop or continuous swing-away stops
4	Double-Swinging (DS) Doors with Removable Stop
5	In-swinging Door with Removable Frame or Split Frame
6	Door within a Door (Wicket) with Concealed Hinges
7	Secondary Door in Sidelite Frame
8	Double Leaf Door with Inactive Leaf
9	Swinging, Non-latching Door
10	Ligature Resistant Sliding Door
11	Out-swinging or Double- Swinging Bathroom Door with Roller Latch
12	No-Door Leaf



Wood Wicket Door

Custom Wood Wicket Door

Multiple Manufacturers

Note:

- **Manufacturing and Installation tolerances result in a wedgeable gap between door leaf and wicket leaf. The primary door leaf's integrity is inherently compromised with the introduction of a wicket door, making it susceptible to breakage.**

ANTI-BARRICADE STRATEGIES	
1	Standard in-swinging door without additional anti-barricade features
2	Out-swinging Doors
3	Double-Swinging (DS) Doors with propriety emergency stop or continuous swing-away stops
4	Double-Swinging (DS) Doors with Removable Stop
5	In-swinging Door with Removable Frame or Split Frame
6	Door within a Door (Wicket) with Concealed Hinges
7	Secondary Door in Sidelite Frame
8	Double Leaf Door with Inactive Leaf
9	Swinging, Non-latching Door
10	Ligature Resistant Sliding Door
11	Out-swinging or Double- Swinging Bathroom Door with Roller Latch
12	No-Door Leaf

Door, Hallway Side



Lock & Handle

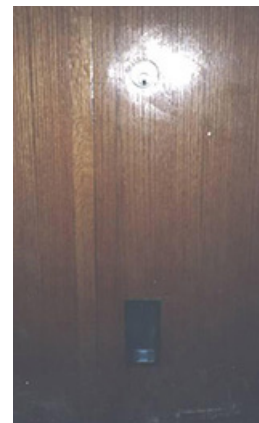

Concealed Hinge





ANTI-BARRICADE STRATEGIES	
1	Standard in-swinging door without additional anti-barricade features
2	Out-swinging Doors
3	Double-Swinging (DS) Doors with propriety emergency stop or continuous swing-away stops
4	Double-Swinging (DS) Doors with Removable Stop
5	In-swinging Door with Removable Frame or Split Frame
6	Door within a Door (Wicket) with Concealed Hinges
7	Secondary Door in Sidelite Frame
8	Double Leaf Door with Inactive Leaf
9	Swinging, Non-latching Door
10	Ligature Resistant Sliding Door
11	Out-swinging or Double- Swinging Bathroom Door with Roller Latch
12	No-Door Leaf

Secondary Door in Sidelite Frame

In-swinging Main Door and Out-swinging Sidelite Door with Center Mullion

Assembly

This assembly uses a hollow metal frame sidelite with an out-swinging panel for anti-barricade. The main door is fitted with ligature-resistant door hardware and has a full hollow metal stop. The sidelite panel can be made of wood or hollow metal and be outfitted with a keyed deadbolt on the corridor side.



ANTI-BARRICADE STRATEGIES	
1	Standard in-swinging door without additional anti-barricade features
2	Out-swinging Doors
3	Double-Swinging (DS) Doors with propriety emergency stop or continuous swing-away stops
4	Double-Swinging (DS) Doors with Removable Stop
5	In-swinging Door with Removable Frame or Split Frame
6	Door within a Door (Wicket) with Concealed Hinges
7	Secondary Door in Sidelite Frame
8	Double Leaf Door with Inactive Leaf
9	Swinging, Non-latching Door
10	Ligature Resistant Sliding Door
11	Out-swinging or Double- Swinging Bathroom Door with Roller Latch
12	No-Door Leaf



Double Leaf Door with Inactive Leaf

Inswinging Active Main Door and Outswinging Inactive Door

Provide keyed flush bolts activated from corridor side on top and bottom of the inactive leaf.

Caution: Door configuration may require special installation requirements when utilizing Door Top Sensor protection.

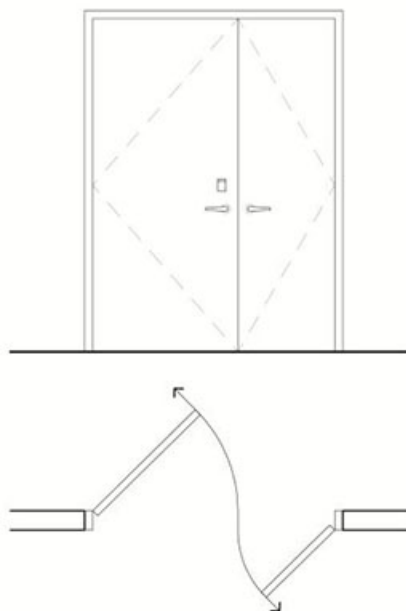

Anti-Barricade Hardware | Constructibility Notes

- Flush bolts shall be substantial enough to withstand significant impact. Bolts may shear off if embedment is inadequate.
- Installation tolerances are critical to provide patient privacy.
- Solid core wood doors may not offer the required durability with this anti-barricade door solution.

Anti-Barricade Strategies

Bathrooms



ANTI-BARRICADE STRATEGIES	
1	Standard in-swinging door without additional anti-barricade features
2	Out-swinging Doors
3	Double-Swinging (DS) Doors with propriety emergency stop or continuous swing-away stops
4	Double-Swinging (DS) Doors with Removable Stop
5	In-swinging Door with Removable Frame or Split Frame
6	Door within a Door (Wicket) with Concealed Hinges
7	Secondary Door in Sidelite Frame
8	Double Leaf Door with Inactive Leaf
9	Swinging, Non-latching Door
10	Ligature Resistant Sliding Door
11	Out-swinging or Double- Swinging Bathroom Door with Roller Latch
12	No-Door Leaf



Safehinge Primera, Inc.

www.safehingeprimera.com

ENP15-300 Ligature Resistant In Suite Bathroom Saloon Door with 11lbs Breakaway

Recommended for en-suite or gang bathrooms. Not recommended as bathroom doors shared between two bedrooms. Soft bathroom privacy door with ligature safe breakaway design, releases with less than 11lbs weight.

Includes frame-mount magnetic hinges and lightweight soft-foam door. Magnets are secured to the door frame and not accessible by patients.

Cautions:

- Cannot achieve positive latching (privacy caution)
- Foam panel can be damaged with a plastic knife.
- Mounting hardware on the panel is hard plastic and may be weaponized if panel is removed.





Accurate Lock & Hardware

www.accuratelockandhardware.com

LR-SDS Anti-Ligature Sliding Door System

Concealed track system hangs a 1 3/4 inch door.
 Concealed floor guide keeps door flush against wall.
 Concealed vertical rod bolt locks into track.
 Ligature-resistant thumb turn LR-ADA-F and flush pull U7001UL.
 Top door edge not accessible.
 Dampened closure.
Caution: Anti-barricade functionality may be compromised by exerting force on the door leaf perpendicular to the direction of sliding.



TRACK CLOSE UP



TRACK CUTAWAY



FLOOR GUIDE

Anti-Barricade Hardware | Constructibility Notes

- Coordination between door opening width, tack length, and door panel width is required.
- Space between wall and door pane is limited to 1/8". Wall base shall be coordinated with this dimensional limitation.

ANTI-BARRICADE STRATEGIES	
1	Standard in-swinging door without additional anti-barricade features
2	Out-swinging Doors
3	Double-Swinging (DS) Doors with propriety emergency stop or continuous swing-away stops
4	Double-Swinging (DS) Doors with Removable Stop
5	In-swinging Door with Removable Frame or Split Frame
6	Door within a Door (Wicket) with Concealed Hinges
7	Secondary Door in Sidelite Frame
8	Double Leaf Door with Inactive Leaf
9	Swinging, Non-latching Door
10	Ligature Resistant Sliding Door
11	Out-swinging or Double- Swinging Bathroom Door with Roller Latch
12	No-Door Leaf

Anti-Barricade Strategies

Bathrooms



Norva Plastics, Inc.
www.norvaplastics.com

Toilet Partitions, Sentinel Event Reduction (SER) Door with Sloped Top

Use only at en-suite or gang bathrooms. Never use in bathrooms shared between two bedrooms. Flexible gasket provides friction stop between partition and frame/wall.

Cautions:

- Cannot achieve positive latching (privacy caution)
- Maintain 3” gaps between partition and frame to prevent wedging (at gasket location)



Norva Plastics, Inc.
www.norvaplastics.com

Toilet Partitions, Sentinel Event Reduction (SER) Door with Collapsible Top

Note: OMH has rejected this product as it contains features that may allow injury to patients including pinched fingers, and if the collapsible edge malfunctions, it provides a ligature point. Also, since the top portion of the door is hollow, the design allows for the possibility of contraband to be placed in the top of the door.

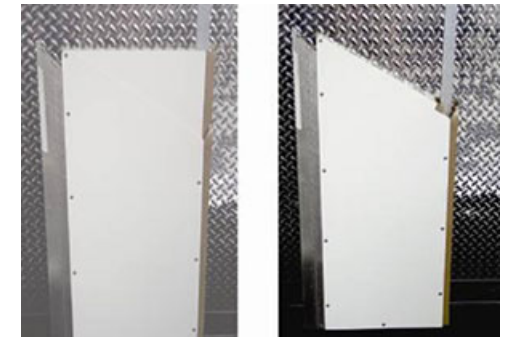

ANTI-BARRICADE STRATEGIES	
1	Standard in-swinging door without additional anti-barricade features
2	Out-swinging Doors
3	Double-Swinging (DS) Doors with propriety emergency stop or continuous swing-away stops
4	Double-Swinging (DS) Doors with Removable Stop
5	In-swinging Door with Removable Frame or Split Frame
6	Door within a Door (Wicket) with Concealed Hinges
7	Secondary Door in Sidelite Frame
8	Double Leaf Door with Inactive Leaf
9	Swinging, Non-latching Door
10	Ligature Resistant Sliding Door
11	Out-swinging or Double- Swinging Bathroom Door with Roller Latch
12	No-Door Leaf

Anti-Barricade Strategies

Bathrooms

ANTI-BARRICADE STRATEGIES	
1	Standard in-swinging door without additional anti-barricade features
2	Out-swinging Doors
3	Double-Swinging (DS) Doors with propriety emergency stop or continuous swing-away stops
4	Double-Swinging (DS) Doors with Removable Stop
5	In-swinging Door with Removable Frame or Split Frame
6	Door within a Door (Wicket) with Concealed Hinges
7	Secondary Door in Sidelite Frame
8	Double Leaf Door with Inactive Leaf
9	Swinging, Non-latching Door
10	Ligature Resistant Sliding Door
11	Out-swinging or Double- Swinging Bathroom Door with Roller Latch
12	No-Door Leaf



Ives
<http://us.allegion.com>

Ives RL32 Roller Latch with ASA Strike

Note: Roller latch is loopable.



Rockwood Manufacturing Company
www.rockwoodmfg.com

592 Roller Latch with 161 Strike

Note: Roller latch is loopable.



Seclusion Room Standards

General Notes

Protrusions and outside corners are not permitted in Seclusion Rooms. Use polycarbonate mirrors for visibility in the corners of room adjacent to the door. Installation of padding systems is recommended on vertical and horizontal surfaces including the door, door frame, window jambs and stool; however, the use of padding is not mandatory. Provide hardware with immediate positive latching (Slam Lock Function). Provide Cremone bolts, multi-bolt or multiple face-mounted magnetic locks on exterior of Seclusion Room (frame and angle at edge of door) with uninterpretable power supply.

Installation Notes

The shear lock alignment is critical for proper function. Shear locks have a tendency to become misaligned over time.

Code Notes

Provide a one hour fire rating at padded room to conform with IBC. In most cases, rating the perimeter of the Seclusion Suite is the most constructible solution. Refer to FGI Guidelines for other specific requirements.



Securitech

www.securitech.com

Multi-Point Deadbolt Mortise Lock

Select lock function from options below:
 USL-K3-IHB2: (slam)
 Latches upon closure.
 Key only projects/retracts bolts and latch.
 Exterior side of door has freely rotating lever/pull.
 Interior cylinder optional.
 UML-K3-IHB2:
 Does not latch upon closure.
 Key only projects/retracts bolts.
 Exterior side of door has freely rotating lever/pull.
 Interior cylinder optional.

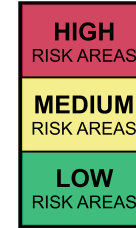

Marathon Engineering Corporation

www.goldmedalsafetypadding.com

Gold Medal Safety Padding

1" thermoset polyurethane elastomer material bonded to 5/16" OSB backer board. Class A finish. Padding material is uniform and smooth with no cracks or open seams.



DuraVision Mirror Systems

www.correctionsmirror.com

Polycarbonate Mirror

Quarter dome polycarbonate mirror. Ligature-resistant connections and tamper-resistant fasteners. Provide tamper-resistant sealant at mirror frame perimeter.

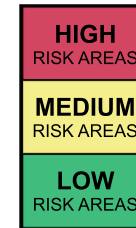

Prime Coat Coating Systems

www.primecoat.com

PC Safe Cell 4730 System

Unified system of high density, high impact rubberized core with bonded polymer topcoats. Padding material is uniform and smooth with no cracks or open seams.



Patient Safety Standards Materials & Systems



Division 01 | General Requirements



Division 01 | General Requirements

Tamper-resistant Fasteners



General Notes

Tamper-resistant fasteners are to be used for all fasteners exposed to view on every product and assembly accessible in the inpatient environment, and should be noted explicitly in the construction documents.



Performance Criteria

ISO 10664:2014 specifies the shape and basic dimensions for bolts and screws, including the gauging method. The curvature of the contour of the hexalobular internal driving feature is defined and additional information which can be used when drawing the contour given.

Alternates

Minimum standard for facilities other than NYS operated: 2-pin spanner head fasteners.

Additional Notes

McGard and Bryce are just two among many acceptable manufacturers of tamper-resistant fasteners relying on limited distribution tools or custom keyed fasteners. Generally custom tooled fasteners like McGard will cost more than stock fasteners.

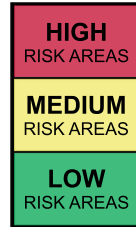

Tamper- Resistant Fasteners

All fasteners accessible to patients shall be tamper-resistant of the hexalobular (6-lobed), pin reject, internal drive system, meeting ISO Standard 10664.

Notes:

- **Limit different types of fasteners used throughout a facility for ease of maintenance.**
- **Fasteners will loosen with use and will require periodic inspection.**



Division 07 | Thermal & Moisture Protection



Division 07 | Thermal & Moisture Protection

Security Sealants, Tamper-resistant



General Notes

Picking and Pica behaviors can impact sealant choices. Tamper-resistant sealants are generally flexible, abrasion resistant and highly tenacious. They are typically urethane or silicone-based sealant technology, in both one and two-component formulas. Tamper-resistant sealants are appropriate for use in most inpatient areas.

Acceptance of product in risk areas is determined primarily by the ligature resistance of the sealant. Tamper resistance is secondary to ligature resistance.

Performance Criteria

ASTM C290.

Installation Notes

All sealants must be installed per manufacturer’s recommendations for ventilation, safety, and cure times.

Additional Notes

Some sealants may not be suitable for use where contact with food may occur. Some sealants may have VOC or other chemical content that generates odors and fumes during curing. All sealants must be reviewed for potential impact on occupants prior to use.



Pecora Corporation

www.pecora.com

Dynaflex SC

Security grade one part polyurethane

- Resistant to ligature in 1/16” joint and at 3/16” joint
- Medium tamper resistance
- Joints can easily be cut with utility knife
- Medium difficulty in application and tooling
- Available in 2 standard colors



Sika Corporation

www.usa.sika.com

Sikaflex 11FC

Tamper-resistant one part polyurethane

- Resistant to ligature in 1/16” joint, slightly resistant at 3/16” joint
- High tamper resistance
- Joints can easily be cut with utility knife
- Easily applied and tooled
- Available in 3 standard colors (white, black, gray)



Dow Corning

www.dowcorning.com

Dowsil 995

Architectural grade one part silicone

- Resistant to ligature in 1/16” joint, slightly resistant at 3/16” joint
- Medium tamper resistance
- Joints can easily be cut with utility knife
- Easily applied and tooled
- Available in 6 standard colors

Division 07 | Thermal & Moisture Protection

Security Sealants, Tamper-resistant

General Notes

Picking and Pica behaviors can impact sealant choices. Tamper-resistant sealants are generally flexible, abrasion resistant and highly tenacious. They are typically urethane or silicone-based sealant technology, in both one and two-component formulas. Tamper-resistant sealants are appropriate for use in most inpatient areas.

Acceptance of product in risk areas is determined primarily by the ligature resistance of the sealant. Tamper resistance is secondary to ligature resistance.

Performance Criteria

ASTM C290.

Installation Notes

All sealants must be installed per manufacturer’s recommendations for ventilation, safety and cure times.

Additional Notes

Some sealants may not be suitable for use where contact with food may occur. Some sealants may have VOC or other chemical content that generates odors and fumes during curing. All sealants must be reviewed for potential impact on occupants prior to use.



Master Builders Solutions

www.master-builders-solutions.com/en-us

MasterSeal CR 195

Security grade one part polyurethane

- Resistant to ligature in 1/16” joint, not resistant at 3/16” joint
- High tamper resistance
- Joints can easily be cut with utility knife
- Difficult to tool
- Available in 3 standard colors



Master Builders Solutions

www.master-builders-solutions.com/en-us

MasterSeal NP-1

Architectural grade one part silicone

- Slightly Resistant to ligature in 1/16” joint, not resistant at 3/16” joint
- High tamper resistance
- Joints can easily be cut with utility knife
- Difficult to tool
- Available in 11 standard colors

Division 07 | Thermal & Moisture Protection

Security Sealants, Pick-Proof

General Notes

Picking and Pica behaviors can impact sealant choices. Tamper-resistant sealants are generally flexible, abrasion resistant and highly tenacious. They are typically urethane or silicone-based sealant technology, in both one and two-component formulas. Tamper-resistant sealants are appropriate for use in most inpatient areas.

Acceptance of product in risk areas is determined primarily by the ligature resistance of the sealant. Tamper resistance is secondary to ligature resistance.

Performance Criteria

ASTM C290.

Installation Notes

All sealants must be installed per manufacturer’s recommendations for ventilation, safety and cure times.

Additional Notes

Some sealants may not be suitable for use where contact with food may occur. Some sealants may have VOC or other chemical content that generates odors and fumes during curing. All sealants must be reviewed for potential impact on occupants prior to use.

Caution Notes

Pick-proof sealant joints cannot be cut. Removal results in damage to substrate.



Sika Corporation

www.usa.sika.com

Sikadur 31High-Mod Gel

Security grade two part epoxy

- Resistant to ligature in all joints when properly tooled
- Pick Proof
- Joints cannot be cut. Removal results in damage to substrate
- Medium difficulty in application and tooling
- Available in one color (gray)



Pecora Corporation

www.pecora.com

Dynapoxy EP-1200

Security grade two part epoxy

- Resistant to ligature in all joints when properly tooled.
- Pick Proof
- Joints cannot be cut. Removal results in damage to substrate.
- Medium difficulty in application and tooling
- Available in 50 standard colors

Division 07 | Thermal & Moisture Protection

Architectural Grade Sealants

General Notes

Picking and Pica behaviors can impact sealant choices. Tamper-resistant sealants are generally flexible, abrasion resistant and highly tenacious. They are typically urethane or silicone-based sealant technology, in both one and two-component formulas. Tamper-resistant sealants are appropriate for use in most inpatient areas.

Acceptance of product in risk areas is determined primarily by the ligature resistance of the sealant. Tamper resistance is secondary to ligature resistance.

Performance Criteria

ASTM C290.

Installation Notes

All sealants must be installed per manufacturer's recommendations for ventilation, safety and cure times.

Additional Notes

Some sealants may not be suitable for use where contact with food may occur. Some sealants may have VOC or other chemical content that generates odors and fumes during curing. All sealants must be reviewed for potential impact on occupants prior to use.



Dow Corning

www.dowcorning.com

Dowsil 795

Architectural grade one part silicone

- Resistant to ligature in 1/16" joint, slightly resistant at 3/16" joint
- Does not resist picking
- Joints can easily be cut with utility knife
- Easily applied and tooled
- Available in 14 standard colors



Dow Corning

www.dowcorning.com

Dowsil 786

Architectural grade one part silicone

- Resistant to ligature in 1/16" joint, slightly resistant at 3/16" joint
- Does not resist picking
- Joints can easily be cut with utility knife
- Easily applied and tooled
- Available in 6 standard colors

Division 08 | Openings



Division 08 | Openings

Door Hardware, General

General Notes

This document is meant to be used in consort with the NYS-OMH Inpatient Adult Standards, Inpatient Children & Youth Standards, Specification Guidelines Section 087100 and Appendix F, and the OMH Facility Program Manual. Numerous lockset functions are appropriate for the hospital setting and these are discussed specifically within the Specification Guidelines.

Doors and hardware present many ligature opportunities. The design team must review all potential ligature opportunities with the facility, determine which are most important to address and identify the most effective remediation methods.

Door opening assemblies present the following potential ligature opportunities that are very difficult to mitigate:

- Looping or wedging over the top of the door leaf
- Wedging between the door and the frame
- Wedging at the hinge

Additional Notes

Specify tamper-resistant, flush mounted set screws. A recessed set screw shaft provides a ligature opportunity for the stiff end of a shoelace.

The specifier must select the appropriate latch bolt for each lock set based on the facility's risk assessment and criteria:

- Standard latch bolt: Provides positive latching and locking. Presents a looping opportunity.
- 2-piece anti-friction latch bolt: Provides positive latching and locking with an increased level of security (resistant to lock-picking). Presents a looping opportunity.
- Beveled latch both: Provides positive latching and locking. Can be compromised with a card and other commonly accessible items (i.e. folder paper). Resists looping.

Installation Notes

Narrower tolerances, required to achieve ligature resistance, necessitate careful installation and more frequent periodic field adjustment than is necessary with traditional lever trim.

Post-installation commissioning of each lockset by the manufacturer is recommended.

Division 08 | Openings

Door Hardware, Continuous Hinges

General Notes

See Door Hardware Introductory Page.

Continuous hinges are recommended for all swinging doors within inpatient units.

Performance Criteria

Specify Hospital Tips (HT) to address ligature point at top of hinge.

Installation Notes

Prepare and reinforce door frame in strict compliance with hardware manufacturer’s written instructions and installation templates.

Additional Notes

See NYS OMH Guidelines Specifications for Hollow Metal Frames and Doors and Solid Core Wood Doors.

Coordinate all door opening assemblies with electronic hardware.

Caution Notes

All hinges inherently carry risk due to multiple joints between moving parts, and extremely low acceptable tolerances. Consistent quality in manufacturing may be difficult to achieve and should be inspected in the field.



Architectural Builders Hardware Mfg. Inc.

www.abhmfg.com

AC500-HT

Stainless steel welded hospital tip and hinge leafs with flanges to encase each barrel.



Pemko

www.pemko.com

HS_HD1-SSHT-xALP

Half-surface heavy-duty aluminum geared continuous hinge



Select Hinges

www.select-hinges.com

SL-57 Hinge with Tipit L Hinge Top

Full surface geared continuous hinge with Tipit Hinge Top Protectors (wide)



Division 08 | Openings

Door Hardware, Continuous Hinges

General Notes

See Door Hardware Introductory Page.

Continuous hinges are recommended for all swinging doors within inpatient units.

Performance Criteria

Specify Hospital Tips (HT) to address ligature point at top of hinge.

Installation Notes

Prepare and reinforce door frame in strict compliance with hardware manufacturer's written instructions and installation templates.

Additional Notes

See NYS OMH Guidelines Specifications for Hollow Metal Frames and Doors and Solid Core Wood Doors.

Coordinate all door opening assemblies with electronic hardware.

Caution Notes

All hinges inherently carry risk due to multiple joints between moving parts, and extremely low acceptable tolerances. Consistent quality in manufacturing may be difficult to achieve and should be inspected in the field.



Markar Architectural Products

www.markar.com

FM300-HT

Edge mount stainless steel.



Stanley Security Solutions

www.stanleyhinges.com

LifeSpan 600 Series

641-HT-Standard Duty

Steel for 1/8" inset doors.

651-HT-Standard Duty

Stainless steel for 1/8" inset doors.

Hospital Tip



Division 08 | Openings

Door Hardware, Handles - Specialty Ligature Resistance

General Notes

See Door Hardware Introductory Page.

Beveled latchbolts can be compromised, permitting access to rooms, and therefore should never be used on locking doors without understanding that the locked door can be easily breached.

Specify a 2-piece anti-friction latchbolt for access to staff-only rooms and other areas identified as low or medium risk.

The specifier must select the appropriate latch bolt for each lock set based on the facility's risk assessment and criteria:

- Standard latch bolt: Provides positive latching and locking. Presents a looping opportunity.
- 2-piece anti-friction latch bolt: Provides positive latching and locking with an increased level of security (resistant to lock-picking). Presents a looping opportunity.
- Beveled latch both: Provides positive latching and locking. Can be compromised with a card and other commonly accessible items (i.e. folder paper). Resists looping.



Accurate Lock & Hardware

www accuratelockandhardware.com

Crescent Handle (CH) & 9100 Lockset (Mortise)

Specify with security grade lock mechanism and narrow escutcheon.

Schlage

www.schlage.com

HSLR Series Ligature-Resistant Lockset (Mortise)

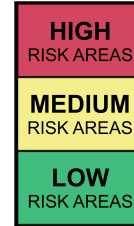

Accurate Lock & Hardware

www accuratelockandhardware.com

Crescent Handle (CH-CYL) & Lockset (Cylindrical)

Schlage

www.schlage.com

HSLR Series Ligature-Resistant Lockset (Cylindrical)

Caution: A lockset function that requires a privacy button may introduce a ligature opportunity.



Division 08 | Openings

Door Hardware, Handles - Specialty Ligature Resistance

General Notes

See Door Hardware Introductory Page.

Beveled latchbolts can be compromised, permitting access to rooms, and therefore should never be used on locking doors without understanding that the locked door can be easily breached.

Specify a 2-piece anti-friction latchbolt for access to staff-only rooms and other areas identified as low or medium risk.

The specifier must select the appropriate latch bolt for each lock set based on the facility's risk assessment and criteria:

- Standard latch bolt: Provides positive latching and locking. Presents a looping opportunity.
- 2-piece anti-friction latch bolt: Provides positive latching and locking with an increased level of security (resistant to lock-picking). Presents a looping opportunity.
- Beveled latch both: Provides positive latching and locking. Can be compromised with a card and other commonly accessible items (i.e. folder paper). Resists looping.



Accurate Lock & Hardware

www accuratelockandhardware.com

9100ALP Push Plate Lockset (Mortise)



dormakaba USA

www.bestaccess.com

Best, Renew 90F Handle (Mortise)

Securitech

www.securitech.com

Solis Handle (Mortise)



Division 08 | Openings

Door Hardware, Handles - Specialty Ligature Resistance

General Notes

See Door Hardware Introductory Page.

Beveled latchbolts can be compromised, permitting access to rooms, and therefore should never be used on locking doors without understanding that the locked door can be easily breached.

Specify a 2-piece anti-friction latchbolt for access to staff-only rooms and other areas identified as low or medium risk.

The specifier must select the appropriate latch bolt for each lock set based on the facility's risk assessment and criteria:

- Standard latch bolt: Provides positive latching and locking. Presents a looping opportunity.
- 2-piece anti-friction latch bolt: Provides positive latching and locking with an increased level of security (resistant to lock-picking). Presents a looping opportunity.
- Beveled latch both: Provides positive latching and locking. Can be compromised with a card and other commonly accessible items (i.e. folder paper). Resists looping.



Corbin Russwin

www.corbinruswin.com

BHSS Trim (Mortise)

Sargent

www.sargentlock.com

BHW Trim (Mortise)

Caution: Installation tolerances must be tight to ensure proper operation. Adjustments shall be made in the field.



Corbin Russwin

www.corbinruswin.com

CLX3300 x BHSS Lockset (Cylindrical)

Sargent

www.sargentlock.com

10XG00 x BHW Lockset (Cylindrical)

Caution: A lockset function that requires a privacy button may introduce a ligature opportunity.



Division 08 | Openings

Door Hardware, Handles - Specialty Ligature Resistance

General Notes

See Door Hardware Introductory Page.

Beveled latchbolts can be compromised, permitting access to rooms, and therefore should never be used on locking doors without understanding that the locked door can be easily breached.

Specify a 2-piece anti-friction latchbolt for access to staff-only rooms and other areas identified as low or medium risk.

The specifier must select the appropriate latch bolt for each lock set based on the facility's risk assessment and criteria:

- Standard latch bolt: Provides positive latching and locking. Presents a looping opportunity.
- 2-piece anti-friction latch bolt: Provides positive latching and locking with an increased level of security (resistant to lock-picking). Presents a looping opportunity.
- Beveled latch both: Provides positive latching and locking. Can be compromised with a card and other commonly accessible items (i.e. folder paper). Resists looping.



Marks USA

www.marksusa.com

5BH Series D-Lig Slide Lockset (Mortise)



Marks USA

www.marksusa.com

195BH Series D-Lig Slide Lockset (Cylindrical)



TownSteel Architectural Hardware Manufacturing

www.townsteel.com

MRX-A Lock with Ligature-Resistant Trim-Arch (Mortise)



TownSteel Architectural Hardware Manufacturing

www.townsteel.com

CRX-A Lock with Ligature-Resistant Trim-Arch (Cylindrical)



Division 08 | Openings

Door Hardware, Handles - Knobs & Paddles

General Notes

See Door Hardware Introductory Page.

Beveled latchbolts can be compromised, permitting access to rooms, and therefore should never be used on locking doors without understanding that the locked door can be easily breached.

Specify a 2-piece anti-friction latchbolt for access to staff-only rooms and other areas identified as low or medium risk.

The specifier must select the appropriate latch bolt for each lock set based on the facility's risk assessment and criteria:

- Standard latch bolt: Provides positive latching and locking. Presents a looping opportunity.
- 2-piece anti-friction latch bolt: Provides positive latching and locking with an increased level of security (resistant to lock-picking). Presents a looping opportunity.
- Beveled latch both: Provides positive latching and locking. Can be compromised with a card and other commonly accessible items (i.e. folder paper). Resists looping.

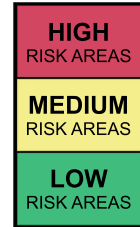

Accurate Lock & Hardware

www accuratelockandhardware.com

Deep Detent Safety Knob (CDDSK) (Cylindrical)



Corbin Russwin

www.corbinrusswin.com

Anti-Harm Knob HSS (Mortise)



Marks USA

<http://marksusa.com>

Institutional Life Safety 5SS50 Series Lockset (Mortise)

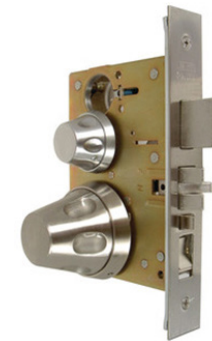

Schlage

<http://us.allegion.com>

SK1 Ligature-Resistant Knob (Cylindrical)



Division 08 | Openings

Door Hardware, Handles - Knobs & Paddles



General Notes

See Door Hardware Introductory Page.

Beveled latchbolts can be compromised, permitting access to rooms, and therefore should never be used on locking doors without understanding that the locked door can be easily breached.

Specify a 2-piece anti-friction latchbolt for access to staff-only rooms and other areas identified as low or medium risk.

The specifier must select the appropriate latch bolt for each lock set based on the facility's risk assessment and criteria:

- Standard latch bolt: Provides positive latching and locking. Presents a looping opportunity.
- 2-piece anti-friction latch bolt: Provides positive latching and locking with an increased level of security (resistant to lock-picking). Presents a looping opportunity.
- Beveled latch both: Provides positive latching and locking. Can be compromised with a card and other commonly accessible items (i.e. folder paper). Resists looping.

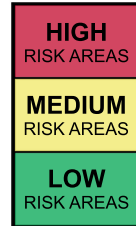

TownSteel Architectural Hardware Manufacturing

www.townsteel.com

CRX-K Ligature-Resistant Trim Knob (Cylindrical)



Division 08 | Openings

Door Hardware, Handles - Knobs & Paddles

General Notes

See Door Hardware Introductory Page.

Beveled latchbolts can be compromised, permitting access to rooms, and therefore should never be used on locking doors without understanding that the locked door can be easily breached.

Specify a 2-piece anti-friction latchbolt for access to staff-only rooms and other areas identified as low or medium risk.

The specifier must select the appropriate latch bolt for each lock set based on the facility's risk assessment and criteria:

- Standard latch bolt: Provides positive latching and locking. Presents a looping opportunity.
- 2-piece anti-friction latch bolt: Provides positive latching and locking with an increased level of security (resistant to lock-picking). Presents a looping opportunity.
- Beveled latch both: Provides positive latching and locking. Can be compromised with a card and other commonly accessible items (i.e. folder paper). Resists looping.



Sargent

www.sargentlock.com

Anti-Harm Knob BHD (Mortise)

Note: A ligature point can be established between the knob and escutcheon plate.



Corbin Russwin

www.corbinrusswin.com

HPSK Push/Pull Paddle

Sargent

www.sargentlock.com

ALP Push/Pull Paddle

Note: A wedge point can be created in the gap required for operational clearance of the paddle. This wedge point can occur when paddles are mounted in either the up, down or side positions.



Division 08 | Openings

Door Hardware, Handles - Levers



Caution: Lever style door trim is not appropriate for high risk areas. It is nearly impossible to completely avoid ligature opportunities with lever style door trim, even if designed to be ligature resistant. At best, lever style door trim is only appropriate for medium and low risk areas.

Division 08 | Openings

Door Hardware, Handles - Levers

General Notes

See Door Hardware Introductory Page.

Beveled latchbolts can be compromised, permitting access to rooms, and therefore should never be used on locking doors without understanding that the locked door can be easily breached.

Specify a 2-piece anti-friction latchbolt for access to staff-only rooms and other areas identified as low or medium risk.

The specifier must select the appropriate latch bolt for each lock set based on the facility's risk assessment and criteria:

- Standard latch bolt: Provides positive latching and locking. Presents a looping opportunity.
- 2-piece anti-friction latch bolt: Provides positive latching and locking with an increased level of security (resistant to lock-picking). Presents a looping opportunity.
- Beveled latch both: Provides positive latching and locking. Can be compromised with a card and other commonly accessible items (i.e. folder paper). Resists looping.

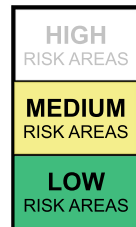
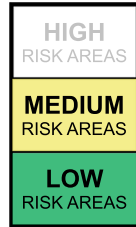

Best Access Systems| Grainger Industrial Supply

www.bestaccess.com
www.grainger.com

Ligature-Resistant Lever Set SPSL Series| LISL/LISE (Mortise)

The ligature-resistant lever handle “free-wheels” in both directions on both sides of the door whether the door is locked or unlocked. **Proprietary finish resists looping by earbuds.**



Schlage

<http://us.allegion.com>

Anti-Ligature Lever SL1 Series & L9000 Locks (Mortise)

Whether locked or unlocked, this lever set “free-wheels” up and down on both the keyed and non-keyed sides of the door. This “free-wheeling” action is standard on double cylinder functions.

Cautions:

- Earbuds can be easily looped around lever handle and remain in place due to friction.
- String can be threaded in the gap between the lever body and escutcheon to establish ligature.



TownSteel Architectural Hardware Manufacturing

www.townsteel.com

Ligature-Resistant Lever Set TRXL Series (Cylindrical)

Whether locked or unlocked, this lever set “free-wheels” up and down on both the keyed and non-keyed sides of the door. This “free-wheeling” action is standard on double cylinder functions.

Cautions:

- Earbuds can be easily looped around lever handle and remain in place due to friction.
- String can be threaded in the gap between the lever body and escutcheon to establish ligature.
- Do not specify with push-button privacy function. Push-button is loopeable.

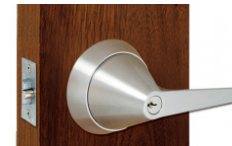

Division 08 | Openings

Door Hardware, Handles - Levers

General Notes

See Door Hardware Introductory Page.

Beveled latchbolts can be compromised, permitting access to rooms, and therefore should never be used on locking doors without understanding that the locked door can be easily breached.

Specify a 2-piece anti-friction latchbolt for access to staff-only rooms and other areas identified as low or medium risk.

The specifier must select the appropriate latch bolt for each lock set based on the facility's risk assessment and criteria:

- Standard latch bolt: Provides positive latching and locking. Presents a looping opportunity.
- 2-piece anti-friction latch bolt: Provides positive latching and locking with an increased level of security (resistant to lock-picking). Presents a looping opportunity.
- Beveled latch both: Provides positive latching and locking. Can be compromised with a card and other commonly accessible items (i.e. folder paper). Resists looping.

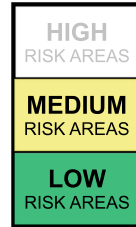

Marks USA

<http://marksusa.com>

Institutional Life Safety 5SS19 Series Lockset (Mortise)

Cautions:

- Earbuds can be easily looped around lever handle and remain in place due to friction.
- String can be threaded in the gap between the lever body and escutcheon to establish ligature.



Marks USA

<http://marksusa.com>

Institutional Life Safety 195SS Lockset, Series (Cylindrical)

Cautions:

- Earbuds can be easily looped around lever handle and remain in place due to friction.
- String can be threaded in the gap between the lever body and escutcheon to establish ligature.
- Do not specify with push-button privacy function. Push-button is loopable.



Division 08 | Openings

Door Hardware, Handles - Levers

General Notes

See Door Hardware Introductory Page.

Beveled latchbolts can be compromised, permitting access to rooms, and therefore should never be used on locking doors without understanding that the locked door can be easily breached.

Specify a 2-piece anti-friction latchbolt for access to staff-only rooms and other areas identified as low or medium risk.

The specifier must select the appropriate latch bolt for each lock set based on the facility's risk assessment and criteria:

- Standard latch bolt: Provides positive latching and locking. Presents a looping opportunity.
- 2-piece anti-friction latch bolt: Provides positive latching and locking with an increased level of security (resistant to lock-picking). Presents a looping opportunity.
- Beveled latch both: Provides positive latching and locking. Can be compromised with a card and other commonly accessible items (i.e. folder paper). Resists looping.



Corbin Russwin

www.corbinruswin.com

BLSS Trim (Mortise)

Note: A variety of ligatures can be looped on lever resulting in downward ligatures.



Sargent

www.sargentlock.com

BHL Trim (Mortise)

Note: A variety of ligatures can be looped on lever resulting in downward ligatures.



TownSteel Architectural Hardware Manufacturing

www.townsteel.com

Ligature-Resistant Lever Set MRXL Series (Mortise)

Note: A variety of ligatures can be looped on lever resulting in downward ligatures.



Division 08 | Openings

Door Hardware, Privacy Thumbturns

General Notes

See Door Hardware Introductory Page.

Toilet Rooms and Bathrooms with privacy functions provide a potential for barricade and self harm because patients are unsupervised. Thumbturns used at these doors must be of a ligature-resistant design.

Specific features available under an “Institutional Privacy” lockset vary between manufacturers. The features needed at each facility should be specifically reviewed with each facility.

Not all door hardware manufacturers provide an institutional privacy function and not all institutional privacy functions are ligature-resistant.

Certain features are mandatory and certain features are subject to facility preference:

MANDATORY:

- ADA compliance
- Ligature resistance of thumbturns
- Outside key override of held thumbturn

OPTIONAL (feature availability may vary by manufacturer):

- Lock releases upon door closing
- Lock does not release upon door closing
- Outside locking of door by key
- No outside locking of door by key

Required anti-barricade strategies and lockset functionality (including Institutional Privacy features) should specifically reviewed with the facility.

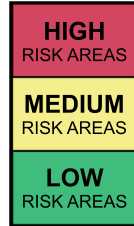

Accurate Lock & Hardware

www accuratelockandhardware.com

ALT-ADA Thumbturn

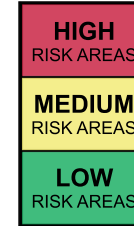

TownSteel Architectural Hardware Manufacturing

www.townsteel.com

RXL Thumbturn

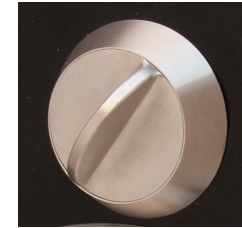

Schlage

<http://us.allegion.com>

Anti-Ligature Thumbturn SL1

Caution: Due to manufacturing tolerances, some samples allow for looping behind thumbturn.



Sargent

www.sargentlock.com

Corbin Russwin

www.corbinrusswin.com

Behavioral Health Thumbturn for use with Sargent Ligature-Resistant Trims

Note: Because outside key does not override thumbturn, an alternative anti-barricade strategy may be warranted.



Division 08 | Openings

Door Hardware, Privacy Thumbturns



General Notes

See Door Hardware Introductory Page.

Toilet Rooms and Bathrooms with privacy functions provide a potential for barricade and self harm because patients are unsupervised. Thumbturns used at these doors must be of a ligature-resistant design.

Specific features available under an "Institutional Privacy" lockset vary between manufacturers. The features needed at each facility should be specifically reviewed with each facility.

Not all door hardware manufacturers provide an institutional privacy function and not all institutional privacy functions are ligature-resistant.

Certain features are mandatory and certain features are subject to facility preference:

MANDATORY:

- ADA compliance
- Ligature resistance of thumbturns
- Outside key override of held thumbturn

OPTIONAL (feature availability may vary by manufacturer):

- Lock releases upon door closing
- Lock does not release upon door closing
- Outside locking of door by key
- No outside locking of door by key

Required anti-barricade strategies and lockset functionality (including Institutional Privacy features) should specifically reviewed with the facility.



Stanley/Best Access Systems

www.bestaccess.com

Female Patient Privacy Thumbturn LTF

Note: A shoelace can be easily slid behind the thumbturn to present ligature opportunity.

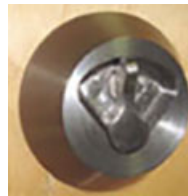

Division 08 | Openings

Door Hardware, Handles - Pulls

General Notes
See Door Hardware Introductory Page.



Accurate Lock & Hardware
www accuratelockandhardware.com

Crescent Pull (CP) Rigid Handle



Architectural Builders Hardware Mfg. Inc.
www.abhmfg.com

1930 Fixed Pull



Accurate Lock & Hardware
www accuratelockandhardware.com

Accurate Recessed ADA Pull (U7001AL)



Division 08 | Openings

Door Hardware, Handles - Pulls

General Notes
See Door Hardware Introductory Page.



Kingsway Group
www.kingswaygroupusa.com

KG30 Easy Grip Pull Handle on Back Plate



Kingsway Group
www.kingswaygroupusa.com

KG60 Classic Grip Handle on Back Plate



Kingsway Group
www.kingswaygroupusa.com

KG40 Ergogrip Pull Handle on Back Plate



Kingsway Group
www.kingswaygroupusa.com

KG61 Classic Grip Pull Handle



Division 08 | Openings

Door Hardware, Handles - Pulls

General Notes
See Door Hardware Introductory Page.



Kingsway Group
www.kingswaygroupusa.com

KG80 Recessed Pull Handle



Division 08 | Openings

Door Hardware, Handles - Pulls

General Notes

See Door Hardware Introductory Page.



Kingsway Group

www.kingswaygroupusa.com

KG70 Face Fixed Recessed Pull Handle

Note: Pull handle can be wedged with a knot to create a downward ligature opportunity.



Rockwood Manufacturing Company

www.rockwoodmfg.com

D89 - Heavy Duty Security Flush Pull

Note: Depth and profile of recess does not provide adequate functionality.



Division 08 | Openings

Door Hardware, Stops

General Notes
See Door Hardware Introductory Page.

Wall-mounted door stops should be selected based upon door knob/lever type and should be mechanically fastened. Stops should be installed with concealed solid wood blocking within the wall. Tamper-resistant sealant may be required around the perimeter depending on the wall surface

Caution Notes
Conventional commercial door stops with concealed fasteners and snap-on cover plates may be tampered with and weaponized.



ABH Manufacturing Inc.
www.abhmfg.com

1841 Dome Wall Stop



Accurate Lock & Hardware
www accuratelockandhardware.com

LR-WS Ligature Resistant Wall Stop



ABH Manufacturing Inc.
www.abhmfg.com

1842 Conical Wall Stop

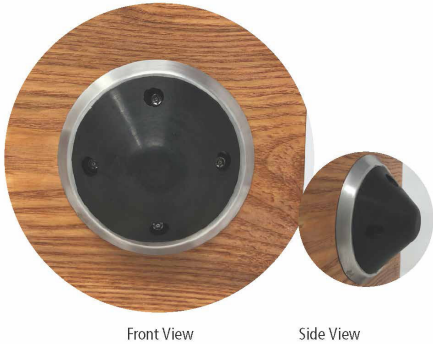

Division 08 | Openings

Door Hardware, Stops

General Notes

See Door Hardware Introductory Page.

Wall-mounted door stops should be selected based upon door knob/lever type and should be mechanically fastened. Stops should be installed with concealed solid wood blocking within the wall. Tamper-resistant sealant may be required around the perimeter depending on the wall surface

Caution Notes

Conventional commercial door stops with concealed fasteners and snap-on cover plates may be tampered with and weaponized.



Kingsway Group

www.kingswaygroupusa.com

KG182 Wall-mounted Door Stop

Solid stainless steel surround with rubber dome. Security screws pass through the rubber part to ensure it can't be removed.



Kingsway Group

www.kingswaygroupusa.com

KG183 Large Rubber Wall Mounted Door Stop

Solid domed rubber door stop.



Division 08 | Openings

Door Hardware, Closers

General Notes

See Door Hardware Introductory Page.

Mount closers on public side of doors to rooms with patient access, or on the secure side of doors that need to automatically lock or latch, such as Store Rooms, Soiled Utility Rooms, and doors with card access readers.

Consider use of concealed closers where risk assessment indicates that surface-mounted closers are not acceptable.

Performance Criteria

Specify gap tolerance at top to be 1/8" maximum.

Doors with concealed closers that are intended to receive door top sensors may require a face-mounted sensor to avoid conflict with the closer arm.

Caution Notes

All closers inherently carry risk. Do not use closers unless required by code, or at doors that shall control patient access in supervised spaces.

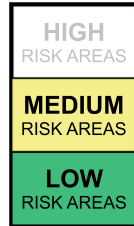

Sargent

www.sargentlock.com

268/269 Series Overhead Concealed Closer

Fully concealed closer body in door frame head. Fully concealed track in door. Track arm is only visible when door is open.



LCN

<http://us.allegion.com>

4510T SMOOTHIE Series Closer

Heavy duty track closer.

NOTE:

For low risk areas, most manufacturers' heavy duty track closers are appropriate.

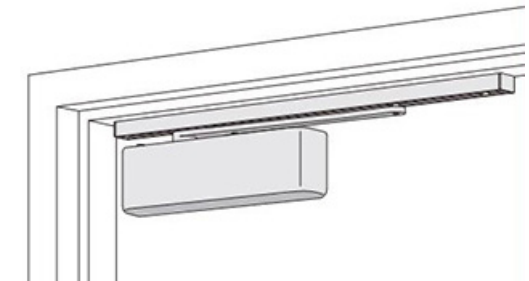
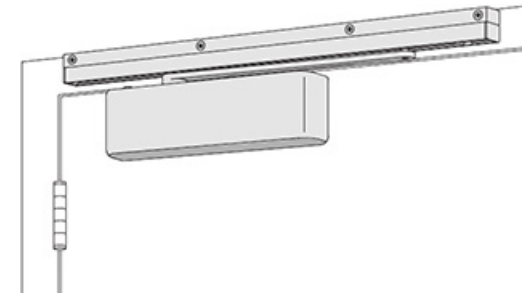

Division 08 | Openings

Door Hardware, Door Top Sensors

General Notes

See Door Hardware Introductory Page.

Alarm annunciation may be visual and/or auditory, and can be provided locally at door and/or remotely at nurse station. Installing alarm resets at the alarmed doors will require staff response to the alarm location.

The tops of doors are traditionally of the most readily available ligature opportunities. Strategies to limit this opportunity include removing doors, cutting down the tops of doors or sloping the tops, and applying door top sensors. Door top sensors use either pressure sensors or light beams.

Installation Notes

The installation of door top sensors must be carefully coordinated with other door hardware items such as closers and continuous hinges. Furthermore, mounting a door top sensor on a door panel that is set in from the face of the hollow metal frame may result in false alarms when the door panel swings past 90 degrees and connects with the frame edge.

An electric transfer hinge may be required with the use of door top sensors.



Door Control Services, Inc.

www.doorcontrolservices.com

Top Door Alarm

The Top Door Alarm involves photoelectric sensors that are positioned on the door frame and on the door within ligature-resistant casings. This ensures maximum coverage by detecting the presence of any foreign objects interrupting the thru-beams between the transmitters and receivers.

Two configurations of the photoelectric sensor type of system are offered;
Configuration A: Two sets of Alarm Light Sensors for top door detection.
Configuration B: One set of Alarm Light Sensors for bottom door detection.

Cautions:

- **This product produces a visible light beam that may be disturbing to patients. It should be noted that beam is continuously visible to patients, especially when bedroom is dark.**
- **Use with caution in a double leaf door configuration with an inactive leaf, as installation requires very tight tolerances.**

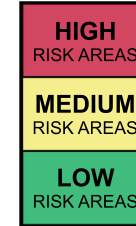

The Door Switch

www.thedoorswitch.com

The Door Switch

Top of door, weight pressure activated sensor that extends above the door.



Division 08 | Openings

Door Hardware, Door Top Sensors



General Notes

See Door Hardware Introductory Page.

Alarm annunciation may be visual and/or auditory, and can be provided locally at door and/or remotely at nurse station. Installing alarm resets at the alarmed doors will require staff response to the alarm location.

The tops of doors are traditionally of the most readily available ligature opportunities. Strategies to limit this opportunity include removing doors, cutting down the tops of doors or sloping the tops, and applying door top sensors. Door top sensors use either pressure sensors or light beams.

Installation Notes

The installation of door top sensors must be carefully coordinated with other door hardware items such as closers and continuous hinges. Furthermore, mounting a door top sensor on a door panel that is set in from the face of the hollow metal frame may result in false alarms when the door panel swings past 90 degrees and connects with the frame edge.

An electric transfer hinge may be required with the use of door top sensors.



dormakaba USA

www.bestaccess.com

SEDA (Secure Emergency Door Alarms)

A pressure activated switch, mounted on the face of a door, provides notification when a foreign object passes over the door and a downward pressure is applied. Notification is sent to a console indicating where a response is required.

Grainger Industrial Supply

www.grainger.com

LISA (Ligature-Resistant Door Alarm)

A pressure activated switch, mounted on the face of a door, provides notification when a foreign object passes over the door and a downward pressure is applied. Notification is sent to a console indicating where a response is required.



Division 08 | Openings

Door Hardware, Door Top Sensor Alarm Visual Notifiers

General Notes
See Door Hardware Introductory Page.



Cooper Lighting Solutions Industries

www.cooperlighting.com

Series RSSB
Multi-color candela, ceiling mount installation only. Notifiers shall be ceiling mounted.

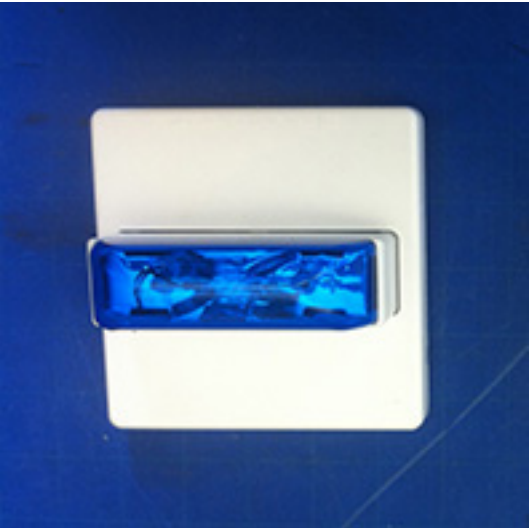

Gentex Corporation

www.gentex.com

Gentex GCSB24PCW Strobe
Multi-color candela, ceiling mount installation only. A mechanical attachment or set screw is required for the cover. Notifiers shall be ceiling mounted.



Division 08 | Openings

Door Hardware, Gasketing

General Notes

NYS-OMH discourages the use of perforated ligature-resistant gasketing because it can easily be torn off, creating an ongoing maintenance concern and reducing the life safety compliance of the physical buildings.



Pemko

www.pemko.com

290AV Perimeter Gasketing Aluminum with Vinyl Insert

Fasteners to be installed 1" from ends and at 6" on center, maximum.

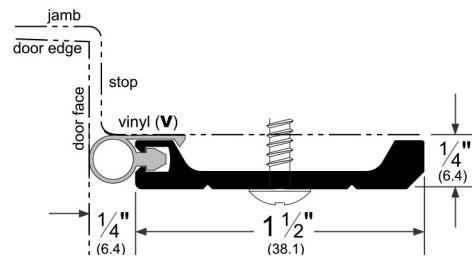

Pemko

www.pemko.com

303APK Perimeter Gasketing Aluminum with Thermal Plastic Elastomer Insert

Fasteners to be installed 1" from ends and at 6" on center, maximum.

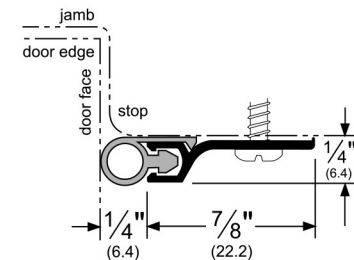

Pemko

www.pemko.com

303AV Perimeter Gasketing Aluminum with Vinyl Insert

Fasteners to be installed 1" from ends and at 6" on center, maximum.

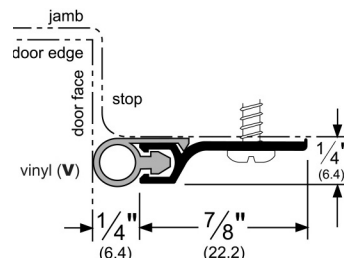

Pemko

www.pemko.com

316AV Perimeter Gasketing Aluminum with Vinyl Insert

Fasteners to be installed 1" from ends and at 6" on center, maximum.

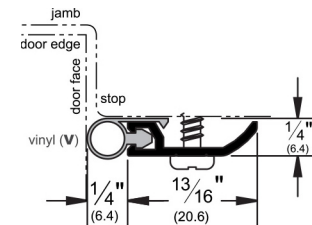

Division 08 | Openings

Door Hardware, Gasketing

General Notes
 NYS-OMH discourages the use of perforated ligature-resistant gasketing because it can easily be torn off, creating an ongoing maintenance concern and reducing the life safety compliance of the physical buildings.



Pemko
www.pemko.com

2891AV Perimeter Gasketing Aluminum with Vinyl Insert

Fasteners to be installed 1" from ends and at 6" on center, maximum.

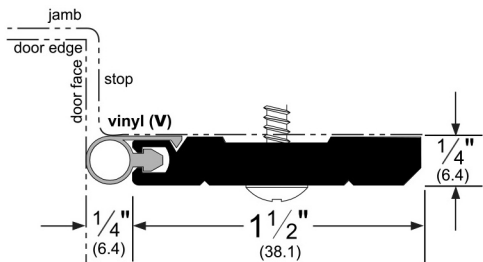

National Guard Products
www.ngp.com

Neoprene Dense Bulb Seal 156V

Fasteners to be installed at each of the manufacturer's pre-slotted holes and no more than 1" from ends.

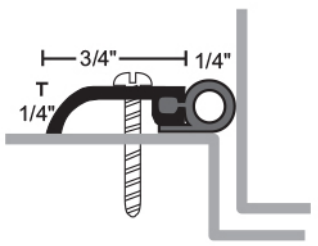

National Guard Products
www.ngp.com

Neoprene Dense Bulb Seal 137N

Fasteners to be installed at each of the manufacturer's pre-slotted holes and no more than 1" from ends.

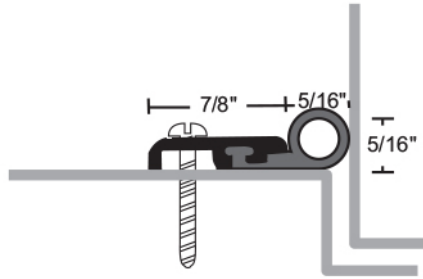

General Notes

Following are risks and performance criteria to consider when specifying glazing in all areas that are accessible to patients, whether unsupervised or supervised. All windows and glazing in areas accessible to patients shall be evaluated as part of the Facility Risk Assessment. Windows and glazing in areas that are not routinely accessible to patients, but may occasionally become accessible to patients (e.g. a staff office that is left unlocked, or an office that is later converted to a Consult Room or Bedroom) should also be considered in the Facility Risk Assessment. Windows and glazing that are identified as a risk to patients for the behaviors listed below should be constructed in accordance with this standard and applicable NYS-OMH specification guidelines. The design and installation of the entire window and glazing system must be considered.

Polycarbonate glazing generally provides the best protection for patients against the various risks listed below. Laminated safety glazing, including the safety film covered laminate products identified in this standard, should be used with caution. Glazing products other than polycarbonate or safety film covered laminated safety glazing should never be used in patient areas. The NYS-OMH does not permit the use of wire glass in its facilities.

The NYS-OMH requires the use of the AAMA A501.8-14 Standard Test Method for Determination of Resistance to Human Impact of Window Systems Intended for Use in Psychiatric Applications (www.fgiaonline.org).

Note: Before specifying laminated glazing in a window unit, confirm that the selected window system has passed the aforementioned impact testing with the specified laminated glazing.

Elopement

Exterior windows, interior windows, and glazing are a primary target for patients trying to elope. Windows and glazing in both supervised and unsupervised areas provide potential opportunities for patients to elope. It is critical to consider the design of the entire window, together with the installation in wall openings, when designing to prevent elopement. Interior windows must not be discounted as potential targets; patients may perceive such windows as potentially leading to elopement opportunities even where that is not the case.

Jumping

Patients may jump in order to hurt themselves, or may attempt to push others through window openings in order to harm them. Jumping is a concern for all spaces above grade level, that are accessible to patients, whether unsupervised or supervised.

Ingestion

Patients may eat things for a variety of reasons, including a wish to cause themselves personal harm. Polycarbonate or laminated glazing protected with a surface film should always be used in patient accessible areas. Even small fragments that can come from tempered or laminated glazing can cause severe internal injuries or death. When considering using laminated glazing, care must be taken to select glazing that meets the following criteria:

- The safety film covered laminated glazing should wholly resist penetration of the glazing panel.
- The safety film covered laminated glazing should wholly retain broken glass to prevent dislodging from the interlayer, and to prevent all off-sharding of fragments.

(continued on the next page)

Division 08 | Openings

Glazing, General

Laceration

Patients will cut themselves. Glass presents an obvious opportunity for such behavior. When considering using laminated glazing, care must be taken to select glazing that meets the following criteria:

- The safety film covered laminated glazing should wholly resist the penetration of the glazing panel.
- The safety film covered laminated glazing should wholly retain broken glass to prevent dislodging from the interlayer, and to prevent all off-sharding of fragments.
- The safety film covered laminated glazing should prevent access to the sharp edges of broken glass, even if they are retained on the interlayer.

Weaponization

Patients may use objects in their environment to harm others. Glass presents an obvious opportunity for such behavior. When considering using laminated glazing, care must be taken to select glazing that meets the following criteria:

- The safety film covered laminated glazing should wholly resist the penetration of the glazing panel.
- The safety film covered laminated glazing should wholly retain broken glass to prevent dislodging from the interlayer, and to prevent all off-sharding of fragments.
- The safety film covered laminated glazing should prevent access to the sharp edges of broken glass, even if they are retained on the interlayer.

Division 08 | Openings

Glazing, Exterior Windows, Polycarbonate Glazing

General Notes

Glazing products other than polycarbonate or laminated safety glazing should never be used in patient areas.

Polycarbonate glazing provides the best protection for the patient against the previously listed risks in all patient areas, where the applicable codes and regulatory authority permit the use of polycarbonate glazing.

For applications that require fire rated assemblies, see Fire Protective Rated and Fire Resistive Rated glazing product pages.



Sabic Innovative Plastics

www.sabic.com/en

FOR USE AS INNERMOST PANE OF EXTERIOR WINDOWS

Lexan SL-4855 Polycarbonate Glazing

1/2" thick with Marguard II-UV coating. Specify MR10 with 10 year warranty.



Plaskolite, LLC

www.plaskolite.com

FOR USE AS INNERMOST SURFACE OF EXTERIOR WINDOWS

Tuffak 15 Polycarbonate Glazing

1/2" thick with abrasion and UV resistant coating. Use with NYS-OMH 15 year warranty.

Division 08 | Openings

Glazing, Exterior Windows, Laminated Safety Glazing

General Notes

Glazing products other than polycarbonate or laminated safety glazing should never be used in patient areas.

Polycarbonate glazing provides the best protection for the patient against the previously listed risks in all patient areas, where the applicable codes and regulatory authority permit the use of polycarbonate glazing.

For applications that require fire rated assemblies, see Fire Protective Rated and Fire Resistive Rated glazing product pages.



Oldcastle Building Envelope

www.oldcastlebe.com

FOR USE AS INNERMOST SURFACE OF EXTERIOR WINDOWS

ArmorProtect Plus 161000 Laminated Security Glazing

3/8" thick. 3M film is scratchable and may be removed from the laminated glass panel and new film installed by trained maintenance staff. Curing time for the film installation is two weeks minimum. Maintenance staff should be advised to keep spare stock that is fully cured to eliminate down time. Install in frames with a 1" continuous edge bite if dry glazed or 1/2" continuous edge bite if silicone glazed.

- Outer Layer:
5/32" heat-strengthened glass
- Interlayer:
0.090" Dupont SentryGlas Plus
- Inner Layer:
5/32" heat-strengthened glass
- Film over Inner Layer:
3M Ultra S800 anti-spall film installed to edge of glass (see Film Pages for equivalents)

Caution: Wet-glazing compounds and cleaning agents have been known to compromise the integrity of the interlayer, and care should be taken with their use. Care should be taken to properly identify the inside face of the glazing and to handle it according to manufacturers' instructions.



Oldcastle Building Envelope

www.oldcastlebe.com

FOR USE AS OUTERMOST SURFACE OF EXTERIOR WINDOWS

Laminated Security Glazing

3/8" thick. Intended for use at grade, courtyards or porches with supervised patient access as an exterior lite in an insulated glazing unit where either 1/2" polycarbonate or 3/8" ArmorProtect Plus 161000 already provides primary patient safety from inside the building.

- Outer Layer:
3/16" heat-strengthened glass
- Interlayer:
0.060" PVB interlayer
- Inner Layer:
3/16" heat-strengthened glass

Caution: Do not use in any area where patients may be left unsupervised.

Division 08 | Openings

Glazing, Exterior Windows, Security Film

General Notes

Films are used on the interior face of exterior glazing, and only when the use of polycarbonate is impractical or where its use is prohibited by Code when a fire resistance rating is required.

Anti-spall films are intended to be applied to conventional glazing materials to prevent release of shards in the event of breakage or other failure. Films may help prevent off-sharding, laceration, weaponizing, and ingestion. Anti-spall films may provide a cost-effective safety improvement for pre-existing conventional glazing materials.

Each facility shall conduct their own Facility Risk Assessment to determine the appropriateness of film applications for use in their specific situations.

Performance Criteria

Extend film to edge of glazing beyond and under the face of the glazing bead/ stop.

Caution Notes

- Films shall not be used in NYS-OMH facilities to prevent elopement,
- Films shall not be used in NYS-OMH facilities to prevent jumping from upper stories,
- Films shall not be used in NYS-OMH facilities for security use at exterior glazing facing non-secure open spaces.

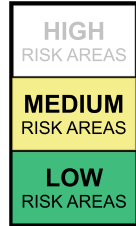

Ace Security Laminates

www.usace.com

200 Series - Standard Security

0.009" thick, 2-ply laminate, 99% UV blocking for use on exterior windows. Lifetime warranty.



Madico

www.safetyshield.com

Safetyshield 1500 Film

High strength glazing film applied to the exposed surface of glass reduces glass breakage and holds broken glass in place until glazing can be replaced.

Division 08 | Openings

Glazing, Interior Windows, Polycarbonate

General Notes

Glazing products other than polycarbonate or laminated safety glazing should never be used in patient areas.

Laminated safety glazing should be used with caution.

1/2" polycarbonate is recommended where elopement or jumping are the risks to be mitigated.

3/8" polycarbonate is recommended where ingesting, laceration, and weaponization are the risks to be mitigated.



Sabic Innovative Plastics

www.sabic.com/en

Lexan SL-4855 Polycarbonate Glazing

3/8" or 1/2" thick with Marguard II-UV coating. Specify MR10 with a 10 year warranty. Install in hollow metal frames with a 1" continuous edge bite, or deeper based on size/width of interior window opening.



Plaskolite, LLC

www.plaskolite.com

Tuffak 15 Polycarbonate Glazing

1/2" thick. Use with NYS-OMH 15 year warranty. Install in hollow metal frames with a 1" continuous edge bite, or deeper based on size/width of interior window opening.

Division 08 | Openings

Glazing, Interior Windows, Laminated Security Glazing



General Notes

Glazing products other than polycarbonate or laminated safety glazing should never be used in patient areas.

Laminated safety glazing should be used with caution.

1/2" polycarbonate is recommended where elopement or jumping are the risks to be mitigated.

3/8" polycarbonate is recommended where ingesting, laceration, and weaponization are the risks to be mitigated.

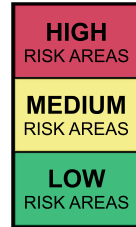

Oldcastle Building Envelope

www.oldcastlebe.com

ArmorProtect Plus 161000 Laminated Security Glazing

3/8" thick. 3M film is scratchable and may be removed from the laminated glass panel and new film installed by trained maintenance staff. Curing time for the film installation is two weeks minimum. Maintenance staff should be advised to keep spare stock that is fully cured to eliminate down time. Install in hollow metal frames with a 1" continuous edge bite if dry glazed or 1/2" continuous edge bite if silicone glazed.

Film over Outer Layer:

3M Ultra S800 anti-spall film installed to edge of glass, or equivalent.

Outer Layer:

5/32" heat-strengthened glass

Interlayer:

0.090" Dupont SentryGlas

Inner Layer:

5/32" heat-strengthened glass

Film over Inner Layer:

3M Ultra S800 anti-spall film installed to edge of glass, or equivalent.

Caution: Wet-glazing compounds and cleaning agents have been known to compromise the integrity of the interlayer, and care should be taken with their use. Care should be taken to properly identify the inside of the glass and to handle it according to manufacturers' instructions.

Division 08 | Openings

Glazing, Interior Windows, Safety Film

General Notes

Films are used on interior glazing between spaces on the same floor level, and only when the use of polycarbonate is impractical or where its use is prohibited by Code when a fire resistance rating is required.

Safety films are intended to be applied to conventional glazing materials to prevent release of shards in the event of breakage or other failure. Films may help prevent off-sharding, laceration, weaponizing, and ingestion. Safety films may provide a cost-effective safety improvement for pre-existing conventional glazing materials.

Each facility shall conduct their own Facility Risk Assessment to determine the appropriateness of film applications for use in their specific situations.

Performance Criteria

Extend film to edge of glazing beyond and under the face of the glazing bead/ stop

Caution Notes

- Safety Films shall not be used in NYS OMH facilities to prevent elopement of jumping
- Safety Films are not for use at interior glazing one or more stories above the adjacent floor space,
- Safety Films are not for use at any upper story exterior glazing,
- Safety Films are not for use at exterior glazing facing non-secure open spaces.

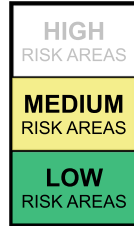

3M

www.3m.com

Ultra S800 Film

3M film is scratchable. When damaged, it may be removed from the glass panel and new film installed by trained maintenance staff. Curing time for the film installation is two weeks minimum. Exact curing time should be verified with the manufacturer. Maintenance staff should be advised to keep spare stock that is fully cured to eliminate down time.

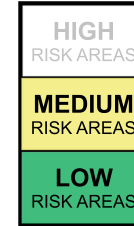

DuPont

www.dupont.com

Spallshield CPET Film

Hard-coated PET film helps stop the showering of small glass particles (called "spall") that can occur when conventional glass fails.

Division 08 | Openings

Glazing, Interior Windows, Safety Film



General Notes

Films are used on interior glazing between spaces on the same floor level, and only when the use of polycarbonate is impractical or where its use is prohibited by Code when a fire resistance rating is required.



Madico

www.safetyshield.com

Safety Shield 800

Safety films are intended to be applied to conventional glazing materials to prevent release of shards in the event of breakage or other failure. Films may help prevent off-sharding, laceration, weaponizing, and ingestion. Safety films may provide a cost-effective safety improvement for pre-existing conventional glazing materials.

Each facility shall conduct their own Facility Risk Assessment to determine the appropriateness of film applications for use in their specific situations.

Performance Criteria

Extend film to edge of glazing beyond and under the face of the glazing bead/stop

Caution Notes

- Safety Films shall not be used in NYS OMH facilities to prevent elopement of jumping
- Safety Films are not for use at interior glazing one or more stories above the adjacent floor space,
- Safety Films are not for use at any upper story exterior glazing,
- Safety Films are not for use at exterior glazing facing non-secure open spaces.

Division 08 | Openings

Glazing, Interior Windows, Fire Protective Rated



General Notes
Do not use wire glazing.

Existing wire glazing should be removed and replaced with polycarbonate or laminated safety glazing wherever possible, or it should be protected with an applied safety film.

Code Notes:
Fire protective glazing is tested per NFPA 252, NFPA 257, UL 9, UL 10B, UL 10C.

Verify usage compliant with applicable Codes.

Code Notes
Fire protective glazing is tested per NFPA 252, NFPA 257, UL 9, UL 10B, UL 10C.

Verify usage compliant with applicable Codes.



Technical Glass Products
www.fireglass.com

FireLite NT2
3/16" thick fire protection and impact safety rated glazing. Listed for use in doors, sidelites, and transoms with fire rating requirements ranging from 20 minutes to 3 hours.



FIRELITE ASSEMBLIES				
RATING	ASSEMBLY	MAX. EXPOSED AREA	MAX. WIDTH OF EXPOSED GLAZING	MAX. HEIGHT OF EXPOSED GLAZING
20 to 60 min.	DOORS (non-temp rise)	3,204 sq.in./22.25 sq.ft.	36"	89"
	DOORS (temp rise)	100 sq.in./0.69 sq.ft.	12"	33"
	OTHER THAN DOORS	3,325 sq.in./23.09 sq.ft.	95"	95"
90 min.	DOORS (non-temp rise)	2,034 sq.in./14.13 sq.ft.	36"	56-1/2"
	DOORS (temp rise)	100 sq.in./0.69 sq.ft.	12"	33"
	OTHER THAN DOORS	2,627 sq.in./18.24 sq.ft.	56-1/2"	56-1/2"
3 hours	DOORS	100 sq.in./0.69 sq.ft.	12"	33"

Check with frame manufacturer for maximum tested glass sizes and required stop height.
NOTE: Individual lite sizes cannot exceed "Max. Exposed Area" listed above.

Division 08 | Openings

Glazing, Interior Windows, Fire Protective Rated



General Notes

Do not use wire glazing.

Existing wire glazing should be removed and replaced with polycarbonate or laminated safety glazing wherever possible, or it should be protected with an applied safety film.

Code Notes:

Fire protective glazing is tested per NFPA 252, NFPA 257, UL 9, UL 10B, UL 10C.

Verify usage compliant with applicable Codes.

Code Notes

Fire protective glazing is tested per NFPA 252, NFPA 257, UL 9, UL 10B, UL 10C.

Verify usage compliant with applicable Codes.



SaftiFirst

www.safti.com

SuperLite Fire Rated Glazing

1/4" monolithic safety and positive pressure fire rated glazing. For use in wood, hollow metal, aluminum or any equally fire rated framing systems.

Traditional fire rated glass with a tough, durable fire rated safety film applied to meet the highest impact safety standard, CPSC 16CFR 1201 Cat. II, which requires withstanding 400 ft. lbs. due to accidental impact.

Notes:

- **These products are rejected because of breakage and shard production.**
- **These products are not tested per ASTM F1233 and therefore are not considered Security Glazing.**
- **Impact safety ratings do not equal security ratings.**
- **While these products have many applications as Safety Impact Glazing, such as in schools and public buildings, they are not intended for special populations where security is also required.**

Division 08 | Openings

Glazing, Interior Windows, Fire Resistive Rated



General Notes

Do not use wire glazing.

Existing wire glazing should be removed and replaced with approved safety glazing wherever possible, or it should be protected with either an applied safety film or 1/8" polycarbonate over face of glazing.



Technical Glass Products

www.fireglass.com

Pilkington Pyrostop

3/4" Pyrostop fire rated, impact safety rated glass sandwiched between two layers of 1/8" polycarbonate.

Code Notes

Fire resistive glazing is tested per ASTM E-119, NFPA 251, UL 263

Verify usage compliant with applicable Codes.

Division 08 | Openings

Glazing, Interior Windows, Sprinkler Protected Polycarbonate



General Notes

This Performance Based System may be applicable and acceptable in certain situations. Verify Code requirements and verify System acceptability with AHJ prior to executing design:

where the authority having jurisdiction will accept NYS-OMH's Southwest Research Institute test (SwRI 01-4779) (not tested per ASTM F1233)



Polycarbonate Protected by Closely Spaced Sprinklers

For up to 120 minute opening protection:

- 3/8" polycarbonate
- Closely spaced (6' O.C. max) sprinklerheads on both sides of glazing.
- Rated HM frame with 5/8" stops

Division 08 | Openings

Glazing, Observation Mirrors



Installation Notes

Install glazing in a hollow metal frame with glazing stops that provide a 5/8" continuous edge bite.



Plaskolite, Inc.

www.plaskolite.com

See-Thru Mirror

One-way observation polycarbonate mirror, 0.236" thick. Product allows a percentage of incident light to pass through while reflecting the remainder. When illuminated, the side with the light source will be reflective and the opposite (darkened) side will be transparent.



Division 08 | Openings

Interior Windows

General Notes

See the NYS-OMH Specification Guideline for 085653 Security Windows for additional information.



Performance Criteria

Alternate minimum standard for facilities other than the newly constructed NYS-OMH operated: Provide detention screen, or windows with sash, frame, and glazing capable of withstanding 2,000 ft-lb impact loads from a 1 foot diameter impact object without breach, dislodging or breakage. The use of alternative window treatments identified elsewhere in this document are an option to integral blinds.



Some manufacturers limit polycarbonate sheet width to 4'-0". Confirm with manufacturer before specifying glazing that exceeds 4'-0" in either direction.

Caution Notes

Windows with casement sashes can be easily looped.

Additional Notes

Structural and architectural detailing of psychiatric windows is critical.

Unicel

unicelarchitectural.com

Unicel BH Interior Window

New Interior Window Applications

Comply with 2,000 ft-lb impact test as specified by NYS-OMH and AAMA 501.8 -14 Standard Test Method for Determination of Resistance to Human Impact of Window Systems Intended for Use in Psychiatric Applications.

- Double-paned insulating unit, 2 3/4" overall thickness having 1/2" thick interior polycarbonate lite and 1/4" thick exterior polycarbonate lite.
- Provide integral operable blinds with ligature-resistant operator.
- Provide ligature-resistant locking mechanism.

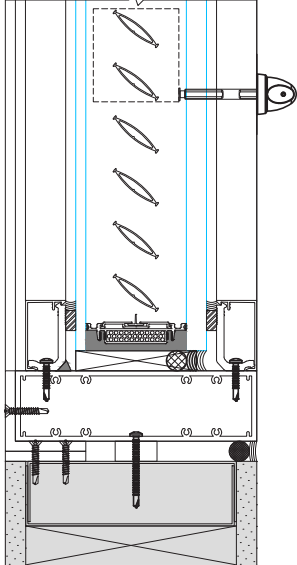

Division 08 | Openings

Interior Windows

General Notes

See the NYS-OMH Specification Guideline for 085653 Security Windows for additional information.



Performance Criteria

Alternate minimum standard for facilities other than the newly constructed NYS-OMH operated: Provide detention screen, or windows with sash, frame, and glazing capable of withstanding 2,000 ft-lb impact loads from a 1 foot diameter impact object without breach, dislodging or breakage. The use of alternative window treatments identified elsewhere in this document are an option to integral blinds.



Some manufacturers limit polycarbonate sheet width to 4'-0". Confirm with manufacturer before specifying glazing that exceeds 4'-0" in either direction.



Caution Notes

Windows with casement sashes can be easily looped.

Additional Notes

Structural and architectural detailing of psychiatric windows is critical.

Unicel

unicelarchitectural.com

Unicel BH Interior Window

Interior Impact Sash

Comply with 2,000 ft-lb impact test as specified by NYS-OMH and AAMA 501.8 -14 Standard Test Method for Determination of Resistance to Human Impact of Window Systems Intended for Use in Psychiatric Applications.

- Double-paned insulating unit, 2 3/4" overall thickness having 1/2" thick interior polycarbonate lite and 1/4" thick exterior polycarbonate lite.
- Provide integral operable blinds with ligature-resistant operator.
- Provide ligature-resistant locking mechanism.

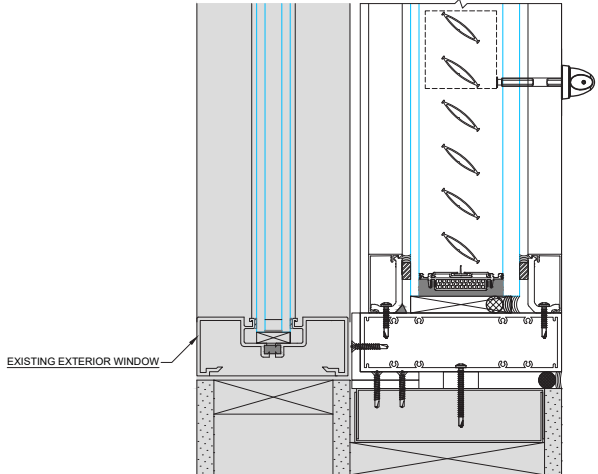

Division 08 | Openings

Interior Windows

General Notes

See the NYS-OMH Specification Guideline for 085653 Security Windows for additional information.



Performance Criteria

Alternate minimum standard for facilities other than the newly constructed NYS-OMH operated: Provide detention screen, or windows with sash, frame, and glazing capable of withstanding 2,000 ft-lb impact loads from a 1 foot diameter impact object without breach, dislodging or breakage. The use of alternative window treatments identified elsewhere in this document are an option to integral blinds.



Some manufacturers limit polycarbonate sheet width to 4'-0". Confirm with manufacturer before specifying glazing that exceeds 4'-0" in either direction.



Caution Notes

Windows with casement sashes can be easily looped.



Additional Notes:

Structural and architectural detailing of psychiatric windows is critical.

Wausau Window & Wall Systems

www.wausauwindow.com

2187-DT SEAL TM Windows

Interior Impact Sash

2187-DT SEAL TM can be installed over existing in-place windows, or as part of aluminum storefront or curtain wall installation.

Comply with 2,000 ft-lb impact test as specified by NYS-OMH and AAMA 501.8 - 14 Standard Test Method for Determination of Resistance to Human Impact of Window Systems Intended for Use in Psychiatric Applications.

- Provide Wausau anti-ligature bar across top of in-projected casement trim in field as required. Run tight to finished jambs.
- Provide 1/2" polycarbonate with 1" continuous edge bite, or deeper based on size/width of window opening.
- Provide integral operable blinds with ligature-resistant operator.
- Provide ligature-resistant locking mechanism.



Division 08 | Openings

Exterior Windows

General Notes

See the NYS-OMH Specification Guideline for 085653 Security Windows for additional information.



Performance Criteria

Alternate minimum standard for facilities other than the newly constructed NYS-OMH operated: Provide detention screen, or windows with sash, frame, and glazing capable of withstanding 2,000 ft-lb impact loads from a 1 foot diameter impact object without breach, dislodging or breakage. The use of alternative window treatments identified elsewhere in this document are an option to integral blinds.



Some manufacturers limit polycarbonate sheet width to 4'-0". Confirm with manufacturer before specifying glazing that exceeds 4'-0" in either direction.

Caution Notes

Windows with casement sashes can be easily looped.

Additional Notes

Structural and architectural detailing of psychiatric windows is critical.

Britplas

www.britplas.com

Safevent Windows

New Exterior Window Applications

Horizontal Sliders. Sliding window assembly with perforated metal screen. Install with operable slider on the exterior. Comply with 2,000 ft-lb impact test as specified by NYS-OMH and AAMA 501.8 -14 Standard Test Method for Determination of Resistance to Human Impact of Window Systems Intended for Use in Psychiatric Applications.

No security screens required.

- Provide 4" opening restriction for operable windows.
- Provide 1/2" polycarbonate with 1" continuous edge bite, or deeper based on size/width of window opening.
- Provide ligature-resistant manual or electric window operator.
- Provide integral operable blinds with ligature-resistant operator.
- Provide ligature-resistant locking mechanism.

View from Interior - Screen on left panel



Window Operator - Manual Knob|Lock

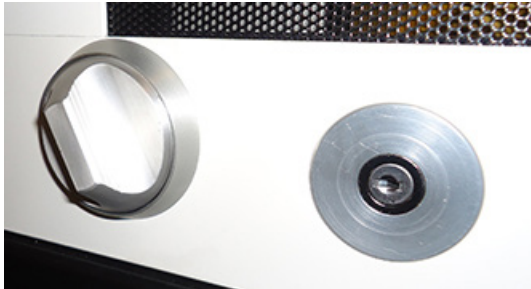

Division 08 | Openings

Exterior Windows

General Notes

See the NYS-OMH Specification Guideline for 085653 Security Windows for additional information.



Performance Criteria

Alternate minimum standard for facilities other than the newly constructed NYS-OMH operated: Provide detention screen, or windows with sash, frame, and glazing capable of withstanding 2,000 ft-lb impact loads from a 1 foot diameter impact object without breach, dislodging or breakage. The use of alternative window treatments identified elsewhere in this document are an option to integral blinds.



Some manufacturers limit polycarbonate sheet width to 4'-0". Confirm with manufacturer before specifying glazing that exceeds 4'-0" in either direction.

Caution Notes

Windows with casement sashes can be easily looped.

Additional Notes

Structural and architectural detailing of psychiatric windows is critical.

Duggan Systems

www.duggansystems.ie

BCW 200 Windows

New Exterior Window Applications

Comply with 2,000 ft-lb impact test as specified by NYS-OMH and AAMA 501.8 -14 Standard Test Method for Determination of Resistance to Human Impact of Window Systems Intended for Use in Psychiatric Applications.

- Provide 1/2" polycarbonate with 1" continuous edge bite, or deeper based on size/width of window opening.
- Provide integral operable blinds with ligature-resistant operator.
- Provide ligature-resistant locking mechanism.



Division 08 | Openings

Exterior Windows

General Notes

See the NYS-OMH Specification Guideline for 085653 Security Windows for additional information.



Performance Criteria

Alternate minimum standard for facilities other than the newly constructed NYS-OMH operated: Provide detention screen, or windows with sash, frame, and glazing capable of withstanding 2,000 ft-lb impact loads from a 1 foot diameter impact object without breach, dislodging or breakage. The use of alternative window treatments identified elsewhere in this document are an option to integral blinds.



Some manufacturers limit polycarbonate sheet width to 4'-0". Confirm with manufacturer before specifying glazing that exceeds 4'-0" in either direction.



Caution Notes

Windows with casement sashes can be easily looped.

Additional Notes

Structural and architectural detailing of psychiatric windows is critical.

Graham Architectural Products

www.grahamwindows.com

S6300 Series Human Impact Window

New Exterior Window Applications

Comply with 2,000 ft-lb impact test as specified by NYS-OMH and AAMA 501.8 -14 Standard Test Method for Determination of Resistance to Human Impact of Window Systems Intended for Use in Psychiatric Applications.

- Provide 1/2" polycarbonate with 1" continuous edge bite, or deeper based on size/width of window opening.
- Provide integral operable blinds with ligature-resistant operator.
- Provide ligature-resistant locking mechanism.



Division 08 | Openings

Exterior Windows

General Notes

See the NYS-OMH Specification Guideline for 085653 Security Windows for additional information.



Performance Criteria

Alternate minimum standard for facilities other than the newly constructed NYS-OMH operated: Provide detention screen, or windows with sash, frame, and glazing capable of withstanding 2,000 ft-lb impact loads from a 1 foot diameter impact object without breach, dislodging or breakage. The use of alternative window treatments identified elsewhere in this document are an option to integral blinds.



Some manufacturers limit polycarbonate sheet width to 4'-0". Confirm with manufacturer before specifying glazing that exceeds 4'-0" in either direction.



Caution Notes

Windows with casement sashes can be easily looped.

Additional Notes

Structural and architectural detailing of psychiatric windows is critical.

Oldcastle Building Envelope

www.oldcastlebe.com

Pinnacle Series 66P Windows

New Exterior Window Applications

Pinnacle Series Moduline Windows, 66P; 4" depth for use with 1" exterior insulated glazing. Comply with 2,000 ft-lb impact test as specified by NYS-OMH and AAMA 501.8 -14 Standard Test Method for Determination of Resistance to Human Impact of Window Systems Intended for Use in Psychiatric Applications.

- Provide 1/2" polycarbonate with 1" continuous edge bite, or deeper based on size/width of window opening.
- Provide integral operable blinds with ligature-resistant operator.
- Provide ligature-resistant locking mechanism.



Division 08 | Openings

Exterior Windows



General Notes

See the NYS-OMH Specification Guideline for 085653 Security Windows for additional information.



Performance Criteria

Alternate minimum standard for facilities other than the newly constructed NYS-OMH operated: Provide detention screen, or windows with sash, frame, and glazing capable of withstanding 2,000 ft-lb impact loads from a 1 foot diameter impact object without breach, dislodging or breakage. The use of alternative window treatments identified elsewhere in this document are an option to integral blinds.

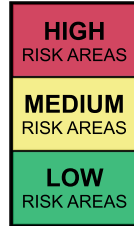

Some manufacturers limit polycarbonate sheet width to 4'-0". Confirm with manufacturer before specifying glazing that exceeds 4'-0" in either direction.

Caution Notes

Windows with casement sashes can be easily looped.

Additional Notes

Structural and architectural detailing of psychiatric windows is critical.

Unicel

unicelarchitectural.com

Unicel BH Exterior Window

New Exterior Window Applications

Comply with 2,000 ft-lb impact test as specified by NYS-OMH and AAMA 501.8 -14 Standard Test Method for Determination of Resistance to Human Impact of Window Systems Intended for Use in Psychiatric Applications.

NOTE: Impact test sample of this window was completed with 1/4" polycarbonate for the exterior lite and with no exterior glazing. IGU can be substituted at exterior lite.

Unicel detail shows unit with 1/4" polycarbonate on the exterior.

- Double-paned insulating unit, 2 3/4" overall thickness having 1/2" thick interior polycarbonate lite and 1/4" thick exterior polycarbonate lite.
- Provide integral operable blinds with ligature-resistant operator.
- Provide ligature-resistant locking mechanism.

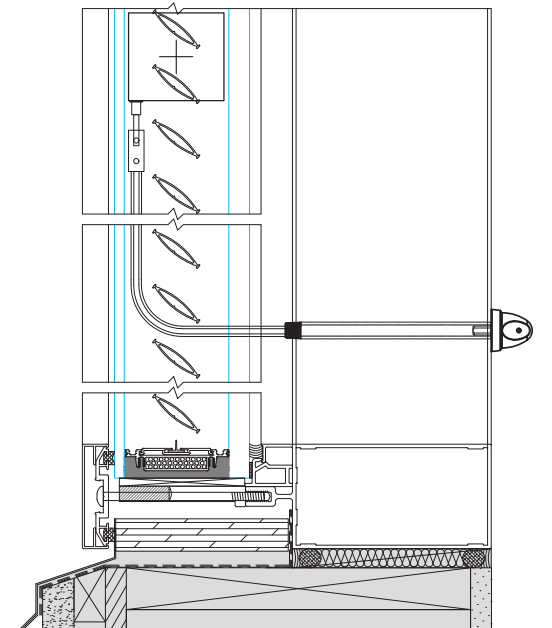

Division 08 | Openings

Exterior Windows

General Notes

See the NYS-OMH Specification Guideline for 085653 Security Windows for additional information.



Performance Criteria

Alternate minimum standard for facilities other than the newly constructed NYS-OMH operated: Provide detention screen, or windows with sash, frame, and glazing capable of withstanding 2,000 ft-lb impact loads from a 1 foot diameter impact object without breach, dislodging or breakage. The use of alternative window treatments identified elsewhere in this document are an option to integral blinds.



Some manufacturers limit polycarbonate sheet width to 4'-0". Confirm with manufacturer before specifying glazing that exceeds 4'-0" in either direction.



Caution Notes

Windows with casement sashes can be easily looped.

Additional Notes

Structural and architectural detailing of psychiatric windows is critical.

Wausau Window & Wall Systems

www.wausauwindow.com

4000i-DT Psychiatric Windows

New Exterior Window Applications

Comply with 2,000 ft-lb impact test as specified by NYS-OMH and AAMA 501.8 - 14 Standard Test Method for Determination of Resistance to Human Impact of Window Systems Intended for Use in Psychiatric Applications.

- Provide Wausau anti-ligature bar across top of in-projected casement trim in field as required. Run tight to finished jambs.
- Provide 1/2" polycarbonate with 1" continuous edge bite, or deeper based on size/width of window opening.
- Provide integral operable blinds with ligature-resistant operator.
- Provide ligature-resistant locking mechanism.



Caution: Do not use low profile, side mount angled or vertical mount angled operators for concealed operable blinds because they create ligature points.

Division 08 | Openings

Doors, Secure Wood Door



General Notes

The door can be prepped for anti-barricade. Refer to the anti-barricade strategy section listed at the beginning of this document for additional information.



Installation Notes

Reinforcement of stud wall construction is required to adequately support the door and resist dynamic impact upon closing.



Ambico
www.ambico.com

Ambico Security Wood Door

High Security non-rated, 14 gauge steel core with wood veneer door.

14 gauge stiffened galvanized steel core with 14 gauge galvanized steel sheets each side, with MDF and wood veneer face sheets applied. Highly vandal, tamper, and impact resistant.

Wood stiles and rails are 3/8" hardwood to match face veneer species.

Doors are insulated for sound attenuation.

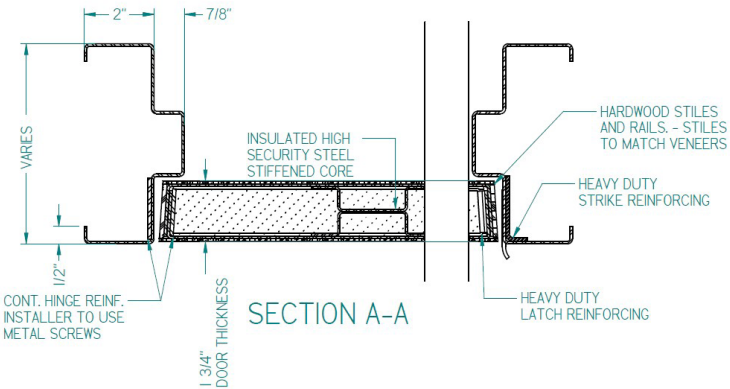
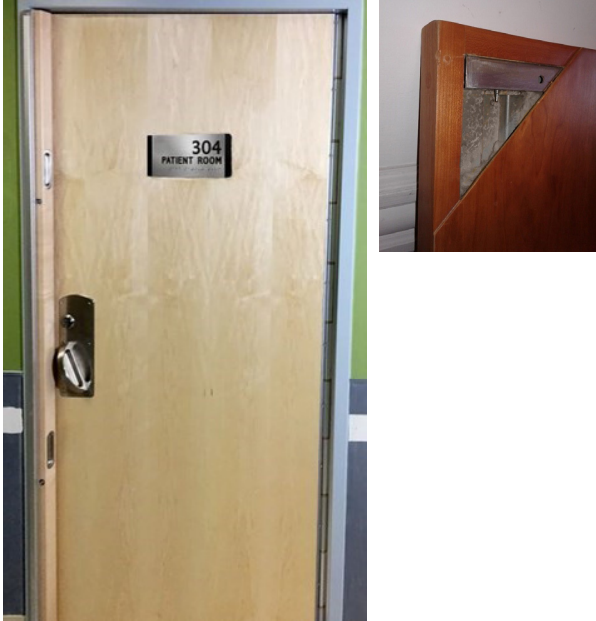

Division 08 | Openings

Access Doors

Installation Notes

Access door frames shall be 16 gauge steel. Access door shall be 20 gauge steel, welded pan type. Door flange shall be 1" wide minimum, for embedment in drywall compound. Hinges shall be continuous. Base metal shall be steel with primer coat of rust inhibitive electrostatic powder baked gray enamel or stainless steel.

The access door may be filled with fire rated insulation. The door shall be self-closing, self-latching and contain an interior latch release.

Locks shall be mortise slam latch with keyed cylinder. All locks shall be keyed alike.

Caution Notes

All access doors inherently carry ligature risk. Avoid the use of access doors in patient areas to the greatest extent possible, particularly in unsupervised areas such as patient bedrooms and bathrooms.



Cendrex

www.cendrex.com

PFI Series Fire Rated Access Doors

Caution: Corners of door panel are not fully mitered. Provide tamper-resistant sealant bead to close the corner.



J. L. Industries

www.jlindustries.com

FDWB Fire Rated Access Panel



Division 09 | Finishes



Division 09 | Finishes

Wall Assemblies, General

Wall Assemblies

The Designer should determine walls that are required to have an STC rating by the applicable codes, regulations, and the Joint Commission. See OMH Design Standards for application of OMH Wall Assemblies.

OMH Wall Assembly 1: 3-5/8" 25 ga actual or EQ (20 ga actual or EQ at single sided walls/plumbing chase) steel studs @ 16" oc. 1 layer 5/8" standard drywall. Refer to other wall assemblies for opposite side wall materials.

- Provide Type-X or Type-C drywall where part of a rated assembly (UL U419).
- Provide water and mold resistant (Green board or Type-M) drywall at locations exposed to moisture (bathrooms, showers, kitchens, dishwashing, pools) regardless of whether a waterproofing and reinforcing membrane system (i.e. Schluter) is provided.
- Provide 3-1/2" fiberglass batt insulation where required for acoustical separation.
- Provide fire treated wood blocking where required for anchoring items to wall.
- Designer to specify height of wall (to above ceiling or underside of deck) based on code requirement, security, structure, and ceiling type.

OMH Wall Assembly 2.1: 3-5/8" 20 ga. (actual, not EQ) steel studs @ 16" oc. 1 layer 5/8" VHI Mold drywall each side . (see OMH Gypsum Board Assemblies Specification Guideline Section 09 21 16). Refer to other wall assemblies for opposite side wall materials.

- Provide 3-1/2" fiberglass batt insulation where required for acoustical separation.
- Provide fire treated wood blocking where required for anchoring items to wall.
- Designer to specify height of wall (to above ceiling or underside of deck) based on code requirement, security, structure, and ceiling type.
- Refer to OMH Gypsum Board Assemblies Specification Guideline (Section 09 21 16) and manufacturer's specifications for locations where Level 5 finishing of abuse resistant drywall may be necessary.

OMH Wall Assembly 2.2: 3-5/8" 20 ga. (actual, not EQ) steel studs @ 16" oc. Floor to 4' aff: 2 layers 5/8" VHI Mold Tough or single layer with protective wainscoting finish material. 4' aff to ceiling: 1 layer 5/8" VHI Mold Tough, additional base layer 5/8" standard drywall if needed for uniform drywall thickness (see OMH Gypsum Board Assemblies Specification Guideline Section 09 21 16). Refer to other wall assemblies for opposite side wall materials.

- Provide Type-X or Type-C drywall where part of a rated assembly (UL U419).
- Provide 3-1/2" fiberglass batt insulation where required for acoustical separation.
- Provide fire treated wood blocking where required for anchoring items to wall.
- Designer to specify height of wall (to above ceiling or underside of deck) based on code requirement, security, structure, and ceiling type.
- Refer to OMH Gypsum Board Assemblies Specification Guideline (Section 09 21 16) and manufacturer's specifications for locations where Level 5 finishing of abuse resistant drywall may be necessary.

OMH Wall Assembly 3: 3-5/8" 20 ga. (actual or EQ) steel studs @ 16" oc. 1 layer 5/8" Type X drywall. Provide 3-1/2" fiberglass batt insulation. Protection padding system (see OMH Specification Guideline Section 13 99 99). Refer to other wall assemblies for opposite side wall materials.

- See IBC Table 509 Incidental use areas "I-2 patient rooms with padding". AHJ may or may not consider seclusion rooms as "patient rooms". Where a suite configuration is provided, rating the perimeter of the suite may be the most constructable solution. Where the functional program dictates an independent seclusion room configuration directly off a corridor without an ante room, a variance for the rating may be required. Consult OMH project manager for precedent variances on file.

(continued next page)

Division 09 | Finishes

Wall Assemblies, General



OMH Wall Assembly 4.1: 3-5/8" 20 ga. actual or EQ steel studs @ 16" oc. 1 layer 5/8" abuse resistant glass mat water-resistant backing board (i.e. GP DensArmor Plus Abuse Resistant (see OMH Specification Guideline Section 09 21 16). Reinforcing and waterproofing membrane (ie Schluter), see OMH Specification Guideline Section 09 30 13). Refer to other wall assemblies for opposite side wall materials.

- This Assembly is intended as a base for ceramic or porcelain tile installed with a waterproofing and reinforcing membrane system (i.e. Schluter). Refer to OMH Specification Guideline Section 09 30 13.
- Provide Type-X abuse resistant panels or additional layer(s) of Type-X or Type-C drywall between backer board and studs where part of a rated assembly (UL U419).
- Provide 3-1/2" fiberglass batt insulation where required for acoustical separation.
- Provide fire treated wood blocking where required for anchoring items to wall.
- Designer to specify height of wall (to above ceiling or underside of deck) based on code requirement, security, structure, and ceiling type.

OMH Wall Assembly 4.2: 3-5/8" 25 ga. actual or EQ (20 ga at single sided walls/plumbing chase) steel studs @ 16" oc. 1 layer 5/8" glass mat water-resistant backing board (i.e. GP DensArmor Plus, see OMH Specification Guideline Section 09 21 16). Refer to other wall assemblies for opposite side wall materials.

- This Assembly is intended as a base for ceramic or porcelain tile installed with a waterproofing and reinforcing membrane system (i.e. Schluter). Refer to OMH Specification Guideline Section 09 30 13.
- Provide Type-X abuse resistant panels or additional layer(s) of Type-X or Type-C drywall between backer board and studs where part of a rated assembly (UL U419).
- Provide 3-1/2" fiberglass batt insulation where required for acoustical separation.
- Provide fire treated wood blocking where required for anchoring items to wall.
- Designer to specify height of wall (to above ceiling or underside of deck) based on code requirement, security, structure, and ceiling type.

OMH Wall Assembly 5: Concrete masonry

- CMU type, thickness, and reinforcing selected by designer.
- Refer to UL U-Series designs where fire resistance ratings are required.

Division 09 | Finishes

Ceiling Assemblies, General



Ceiling Assemblies

The Designer should determine ceilings that are required to have an STC rating or Special Acoustic properties. Ceiling heights should be evaluated based on patient population and risk levels. Frequent accessibility to MEP items above the ceiling and vulnerability to access door should be considered when selecting a ceiling system. See OMH Design Standards for application of OMH Ceiling Assemblies.

OMH Ceiling Assembly 1: 1 layer 5/8" drywall. Metal framing.

- Provide Type-X or Type-C drywall where part of a rated assembly.
- Provide water resistant (Green board or Type-M) drywall at locations exposed to moisture (bathrooms, showers, kitchens, dish washing).
- Design metal framing and hangers to accommodate ceiling weight.

OMH Ceiling Assembly 2: 1 layer 5/8" abuse resistant drywall. Metal framing.

- Provide Type-X or Type-C abuse resistant drywall where part of a rated assembly.
- Design metal framing and hangers to accommodate ceiling weight.
- Access doors are necessary where required and may create a ligature issue.

OMH Ceiling Assembly 3: 3/4" suspended acoustic ceiling tile (fiberglass, mineral fiber or perforated aluminum). Intermediate duty suspension system.

- This is a non-fire rated ceiling system.
- Washable/water resistant panel to be used in food preparation areas, Kitchens, Pantries, and Dining Rooms.
- Do not use hold down clips, especially in any patient areas. Instead use an alternate Ceiling Assembly.
- Do not use loose batt insulation above ceilings to achieve acoustical separation between spaces.
- Consider use of perforated metal ceiling tiles. While an increased cost, they offer better acoustics and resistance to damage.

OMH Ceiling Assembly 4: Class A Fiberglass Reinforced Plastic (FRP) (Kemlite) ceiling panel. FRP suspension system (Kemlite Sanigrad II) with 12 ga. stainless steel hanger wire.

- This is a non-fire rated ceiling system.
- Select ceiling panel material based on code and surface finish requirements.

OMH Ceiling Assembly 5: Security type metal tile or plank system. Product specific security type suspension system braced to deck above and restrained at full perimeter with proprietary ceiling panels offering varying levels of abuse resistance and plenum access using special tools.

OMH Ceiling Assembly 6: Tectum panels. Continuous steel reinforced, corridor span panels with tegular edges and concealed suspension components.

- Verify Tectum availability with manufacturers. Armstrong Industries manufactures 1" ceiling tiles and 2" panels not suitable for this Assembly application. Condeck Corp. (NM) and Tectum, Inc. (OH) are resources for plank products with tegular steel channel reinforcing suitable for this assembly but primarily intended as roof deck materials.
- Plank products when properly detailed and installed do not offer above ceiling access. Access doors are necessary where required and may create a ligature issue.

Division 09 | Finishes

Wall Base

General Notes

Use only heat welded integral cove base, solid wood or pre-finished rubber/PVC base.

Installation Notes

Integral Cove Base: Adhere base to wall. Provide tamper-resistant sealant along the top edge of base.

Wood and rubber Wall Base: Adhere and mechanically fasten base to wall. Fasteners shall be screwed into wood blocking, countersunk and filled.

Caution Notes

Do not specify conventional commercial vinyl or rubber wall base in patient areas. These products are easily removable, presenting risk of weaponization.



Custom Wood Base

Custom Designed Wood Base

Solid 3/4" hardwood with eased or bullnose top and corners. Provide tamper-resistant sealant at joint between floor and base, base and wall surface. Finish six sides of all wood base prior to installation.



Johnsonite

www.johnsonite.com

Millwork Contoured Wall Base

Thermoplastic solid rubber base. Various profiles range in height from 2-1/2" to 6" high, 1/4" to 3/8" thick.

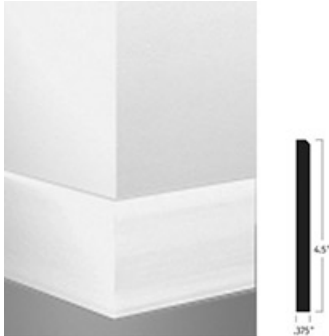

Division 09 | Finishes

Wall Base

General Notes

Use only heat welded integral cove base, solid wood or pre-finished rubber/PVC base.



Installation Notes

Integral Cove Base: Adhere base to wall. Provide tamper-resistant sealant along the top edge of base.



Wood and rubber Wall Base: Adhere and mechanically fasten base to wall. Fasteners shall be screwed into wood blocking, countersunk and filled.

Caution Notes

Do not specify conventional commercial vinyl or rubber wall base in patient areas. These products are easily removable, presenting risk of weaponization.

Flexco

www.flexcofloors.com

Health Design Wall Base

Thermoplastic rubber base tapers from 1/8" thick to adjacent floor thickness. All seams are heat welded.



Johnsonite

www.johnsonite.com

SCC-XX-A Cove Cap Moulding

Vinyl cove cap molding accessory for 1/8" cove base material.

Note: Material can be pulled out of place in installation and weaponized.



Division 09 | Finishes

Ceilings

General Notes

Security ceiling panels are removable with use of special tools to remove ceiling panels.

Perforated panels pose a ligature risk. Perforation patterns of 1/8" or less have been shown to resist looping but do not entirely eliminate risk. The specifier must carefully review these products to determine whether the inherent risk of perforated products is appropriate for use prior to specification.

Installation Notes

Coordination is required between security ceiling systems and installation of any devices and fixtures that penetrate the ceiling plane.

Specifier shall select steel or aluminum gauge or aluminum based on finished ceiling heights and risk levels of installation areas.



Gordon Incorporated

www.gordon-inc.com

WinLok Accessible Soffit System

0.050" aluminum 30" x 30" panels and manufacturer's standard system suspension grid and WA-20 2" x 2" extruded perimeter angle and AV3 panel hold-down angle at perimeter. All exposed finishes powder-coated after perforations.

Acceptable Perforation patterns:

- R564-732DG10 (10% Open Area)
- R18-2164SG13 (13% Open Area)
- R18-14ST20 (20% Open Area)
- R18-14SG23 (23% Open Area)

OMH Ceiling Assembly: 5 (page 96)

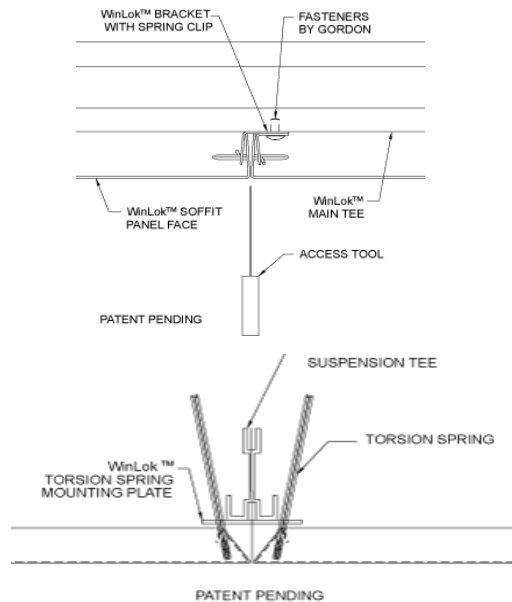

Gordon Incorporated

www.gordon-inc.com

Cel Line Metal Plank Security Ceilings

14 GA. 2' wide galvanized steel panels and manufacturer's 14 GA galvanized steel perimeter angle. Panels surface-screwed to perimeter angle @ 6" o.c. All exposed finishes powder-coated after all perforations. Back side of panels powder-coated. 2' x 2' access door installed in ceiling.

Acceptable Perforation Patterns:

- R18-1132DG11 (11% Open Area)

OMH Ceiling Assembly: 5 (page 96)

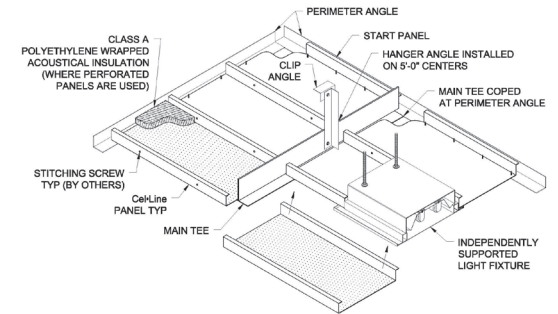

Division 09 | Finishes

Ceilings

General Notes

Security ceiling panels are removable with use of special tools to remove ceiling panels.



Perforated panels pose a ligature risk. Perforation patterns of 1/8" or less have been shown to resist looping but do not entirely eliminate risk. The specifier must carefully review these products to determine whether the inherent risk of perforated products is appropriate for use prior to specification.



Installation Notes

Coordination is required between security ceiling systems and installation of any devices and fixtures that penetrate the ceiling plane.

Specifier shall select steel or aluminum gauge or aluminum based on finished ceiling heights and risk levels of installation areas.

Gordon Incorporated

www.gordon-inc.com

Lockdown Metal Panel Security Ceiling

18 GA. 2' x 2' galvanized steel "lockdown" panels and manufacturer's perimeter channel with 24 GA z-hold down. Grid system comprised of main tees at 12'-0" o.c. with cross tees at 4'-0" and 2'-0" o.c. Lockdown infill panels pressure fit into grid. All exposed finishes powder-coated after all perforations are cut into panel.

Access door options include hinged door and 2' x 2' access door surface mounted to grid with tamper resistant screws. Frequent removal of tamper resistant screws may compromise the installed ceiling assembly due to wear on the screw threads and to the ceiling grid. Project team should review access requirements with owner to determine frequency of access door use and the best method for access.

Acceptable Perforation Patterns:

- R564-732DG10 (10% Open Area)

OMH Ceiling Assembly: 5 (page 96)

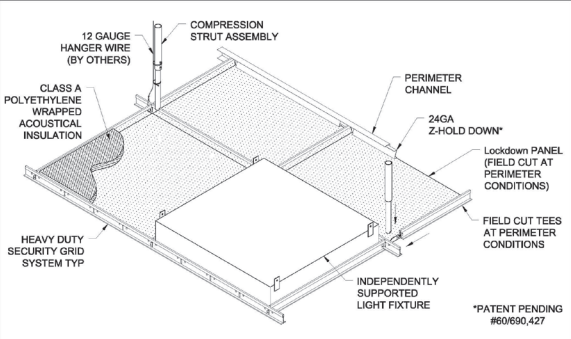

Carritec

www.carritec.com

Series CO Clip-On Panel System

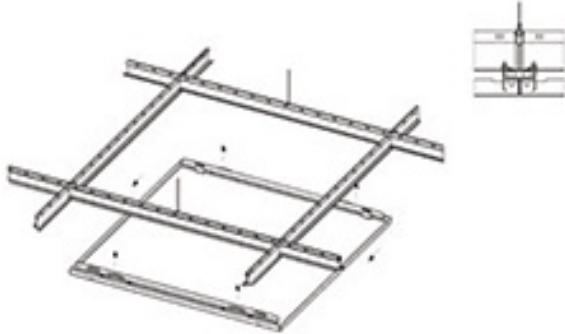

Division 10 | Specialties



Division 10 | Specialties

Shower & Privacy Curtain Track System

General Notes

Users shall perform a risk assessment to determine their options for shower and privacy curtains.

Specify breathable fabric material for shower and privacy curtains.

Installation Notes

Recessed ceiling track shall run continuously between walls. Surface-mounted ceiling track shall run continuously between walls, or be installed with secure end caps. Fill all joints between sections of track with tamper-resistant sealant to reduce opportunities for ligation.

Caution Notes

- End caps can create opportunity for a wedge ligation.
- A looping point can be created in curtain tracks when an object, such as a penny, is inserted into the track.
- The breakaway weight for curtain carriers may exceed the limits at which self-harm can be induced. Carriers can be ganged together to increase the release weight.
- Track system may be weaponized if subjected to severe abuse and dismantled.



InPro Corporation

www.inprocorp.com

Clickeze Ultra Cubicle Track

Extruded aluminum track provides heavy duty strength. For use with Clickeze accessories.

Clickeze Whisper Cubicle Track

Extruded PVC track allows for noise reduction during curtain movement. For use with Clickeze accessories.

Ultra Track



Whisper Track

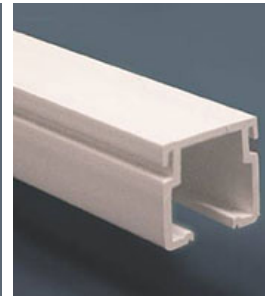

Caution: Potential looping point at curtain tracks.

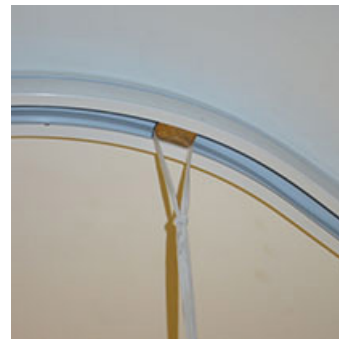

InPro Corporation

www.inprocorp.com

Clickeze Pop Out Carrier

Hook on carrier releases, allowing the curtain to fall, and disengages at approximately 10 lbs. of pressure. For use with both Clickeze Ultra and Whisper Curtain Tracks.



Division 10 | Specialties

Shower & Privacy Curtain Track System



General Notes

Users shall perform a risk assessment to determine their options for shower and privacy curtains.

Specify breathable fabric material for shower and privacy curtains.

Installation Notes

Recessed ceiling track shall run continuously between walls. Surface-mounted ceiling track shall run continuously between walls, or be installed with secure end caps. Fill all joints between sections of track with tamper-resistant sealant to reduce opportunities for ligation.

Caution Notes

- End caps can create opportunity for a wedge ligation.
- A looping point can be created in curtain tracks when an object, such as a penny, is inserted into the track.
- The breakaway weight for curtain carriers may exceed the limits at which self-harm can be induced. Carriers can be ganged together to increase the release weight.
- Track system may be weaponized if subjected to severe abuse and dismantled.

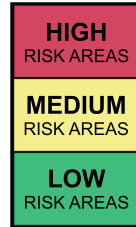

Oddball Industries

www.oddballindustries.com

HealSafe Interiors J-Trac Curtain Rail SP-2 (Wall Mount or Ceiling Mount)

Hook on carrier is designed to clip onto the J-Trac curtain rail and releases from track when downward pressure is applied. The curtain rail can be ceiling or wall-mounted.

Caution: A wall-mounted installation can hold a downward ligature of 20lbs. when several hooks are ganged together.

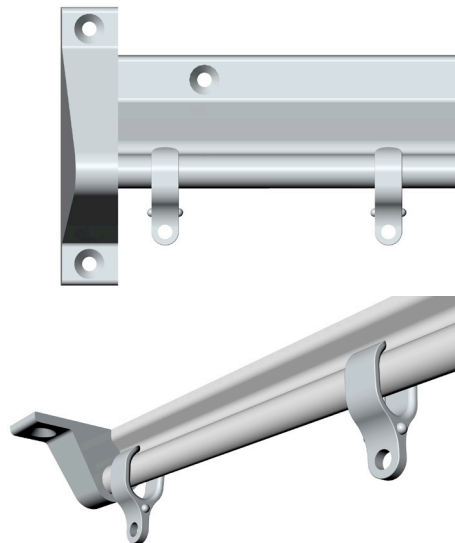

Construction Specialties, Inc.

www.c-sgroup.com

Breakaway Carrier #975P

Hook on carrier is designed to pop out of the axle when approximately 22 lbs. of pressure is applied to the hook, and can be reused.



Division 10 | Specialties

Shower & Privacy Curtain Track System

General Notes

Users shall perform a risk assessment to determine their options for shower and privacy curtains.

Specify breathable fabric material for shower and privacy curtains.

Installation Notes

Recessed ceiling track shall run continuously between walls. Surface-mounted ceiling track shall run continuously between walls, or be installed with secure end caps. Fill all joints between sections of track with tamper-resistant sealant to reduce opportunities for ligation.

Caution Notes

- End caps can create opportunity for a wedge ligation.
- A looping point can be created in curtain tracks when an object, such as a penny, is inserted into the track.
- The breakaway weight for curtain carriers may exceed the limits at which self-harm can be induced. Carriers can be ganged together to increase the release weight.
- Track system may be weaponized if subjected to severe abuse and dismantled.



AFS Security

www.afs-securitysystems.com

Kestrel Movatrack

Movatrack curtain suspension system utilizes magnetic wall brackets where the track meets the wall, and ceiling brackets with suspension hangers at ceilings. Under excess loads, the suspension hangers separate from the ceiling brackets.

Note: Loose parts can be ingested and ease of disassembly is likely to be a nuisance to staff.

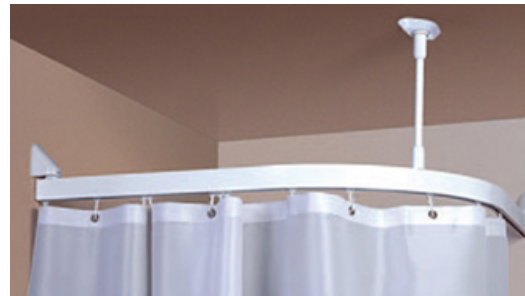

Imperial Fastener Company

www.imperialfastener.com

IFC-69 Break-A-Way Track & IFC-79 Break-A-Way Track

The IFC-69 ceiling mounted and IFC-79 wall-mounted tracks are used with “Safety Tabs” that attach to box pleated window draperies or shower curtains.

Notes:

- Velcro on “Safety Tabs” creates a tie off ligation point.
- IFC-79 wall-mounted curtain track can be continuously looped end to end.

IFC-69 Break-A-Way Track



IFC-79 Break-A-Way Track



Division 10 | Specialties

Closet Rods, Clothes & Towel Hooks

Code Notes
 2018 FGI “Guidelines for the Construction of Hospitals and Outpatient Facilities” requires that; “Shelves for folded garments shall be used instead of arrangements for hanging garments.”



Behavioral Safety Products

www.besafeprod.com

TH770 Towel Hook

Powder-coated aluminum with center grip. Half moon holder releases and pivots downward under applied load.

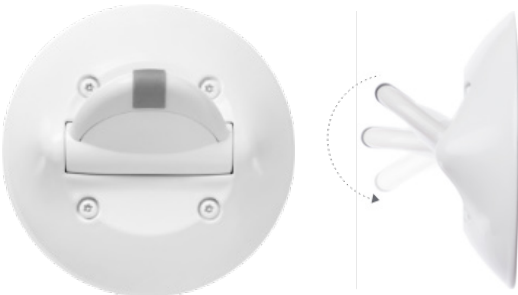

Whitehall Manufacturing

www.whitehallmfg.com

WH1830A-SLPT Single Hook

Adjustable auto release clothes hook.

Note: Adjust tension in ball joint to ensure release of hook.



Norva Plastics, Inc.

www.norvaplastics.com

Suicide Reduction Clothes Hook

Polyethylene Hook

Caution: Hook can be tied off to form a side ligature point. Installation location should be considered to prevent a second point of ligature.



Kingsway Group

www.kingswaygroupusa.com

KG180 Coat Hook

Stainless steel surround. Rubber hook releases under downward applied load.



Division 10 | Specialties

Closet Rods, Clothes & Towel Hooks

Code Notes

2018 FGI “Guidelines for the Construction of Hospitals and Outpatient Facilities” requires that; “Shelves for folded garments shall be used instead of arrangements for hanging garments.”



AFS Security

www.afs-securitysystems.com

K507 Coat Hook

Note: Loose parts can be ingested and ease of disassembly is likely to be a nuisance to staff.



Bradley Corporation

www.bradleycorp.com

Model SA36 Tension Towel Hook

Note: Hook can be tied off to form a ligature point.



American Specialties, Inc.

www.americanspecialties.com

123 Square Clothes Hook

Oddball Industries

www.oddballindustries.com

SP-6 Clothes/Towel Hook SP-6A Clothes/Towel Hook with adjustable tension release

Note: Hook can be tied off to form a ligature point.



HenkelHook

www.henkelhook.com

HenkelHook

Note: Hook can be wedged to create a ligature point.



Division 10 | Specialties

Closet Rods, Clothes & Towel Hooks

Code Notes
 2018 FGI “Guidelines for the Construction of Hospitals and Outpatient Facilities” requires that; “Shelves for folded garments shall be used instead of arrangements for hanging garments.”



Laidlaw
www.laidlawdirect.com

Orbis Coat Hook 81.AL8.03
 Ligature-resistant spherical casing. Hook can support the weight of a small coat but releases under downward applied load.

Note: Hook can be tied off to form a ligature point.



Norix
www.norix.com

Towel Hook

Note: Hook can be tied off with a loop to form a ligature point.



Oddball Industries
www.oddballindustries.com

SP-1 Closet “Bar”

Note: Hangers may be ganged together to increase breakaway weight.

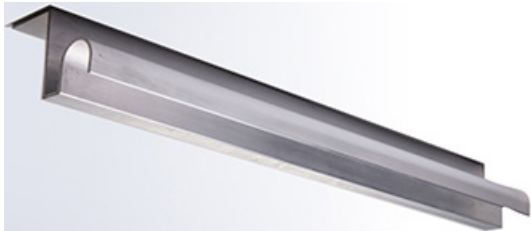

Willoughby Industries, Inc.
www.willoughby-ind.com

CTH-4 Clasp Type Towel Hook

- Notes:**
- Hooks can be tied off of to form a ganged ligature point
 - Clasp style hook allow for wedging opportunities



Division 10 | Specialties

Handrails & Grab Bars, General



General Notes

Nearly all handrails and grab bars are subject to possible wedge ligature with a shoe or other object.

Grab bars should only be installed where required by code.

Installation Notes

Verify that all handrails and grab bars are installed per the manufacturer's installation instructions. Proper installation is critical in order for tight tolerances between the multiple product pieces.

Sealant may be required to fill voids around the perimeter of handrails and grab bars depending on installation substrate.

Caution Notes

Traditional code compliant handrails and grab bars create obvious ligature opportunities.



Division 10 | Specialties

Handrails



General Notes

All handrails are subject to possible wedge ligature with a shoe or other object.

Installation Notes

Verify that all handrails are installed per the manufacturer’s installation instructions. Proper installation is critical in order for tight tolerances between the multiple product pieces.

Sealant may be required to fill voids around the perimeter of handrails depending on installation substrate.

Additional Notes

The inside of handrails with continuous mounting brackets are susceptible to the collection of debris.

Caution Notes

Traditional code compliant handrails create obvious ligature opportunities.



InPro Corporation

www.inprocorp.com

1000BH Handrail

Continuous aluminum retainer bracket and specially designed molded returns reduce the gap between the handrail and substrate.

Notes:

- Cover shall be installed using tamper-resistant sealant, as recommended by manufacturer, to reduce risk of removal.
- Corner pieces are not available with this handrail system.

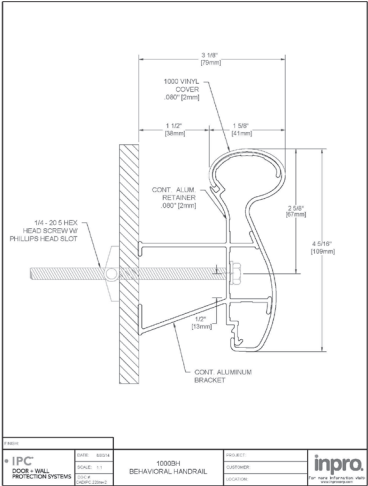
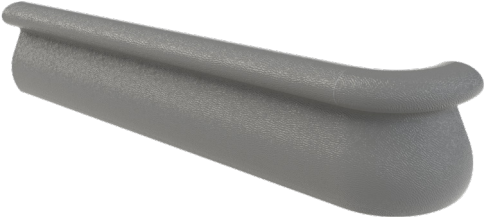

Division 10 | Specialties

Handrails

General Notes

All handrails are subject to possible wedge ligature with a shoe or other object.

Installation Notes

Verify that all handrails are installed per the manufacturer's installation instructions. Proper installation is critical in order for tight tolerances between the multiple product pieces.

Sealant may be required to fill voids around the perimeter of handrails depending on installation substrate.

Additional Notes

The inside of handrails with continuous mounting brackets are susceptible to the collection of debris.

Caution Notes

Traditional code compliant handrails create obvious ligature opportunities.



Pawling Corporation

www.pawling.com

BR-400CS Series Handrail

6-1/4" high vinyl handrail. Ligature-resistant design to minimize leverage and looping with radius corners. Aluminum tube with laser cut 1/8" aluminum closure plates. Continuous secure bracket.

Caution: Cover is easily removable and can be broken or weaponized.



Pawling Corporation

www.pawling.com

BR-500 Series Handrail

5-1/2" high vinyl handrail. Ligature-resistant design to minimize leverage and looping with radius corners. Aluminum tube with laser cut 1/8" aluminum closure plates. Continuous secure bracket.

Caution: Cover is easily removable and can be broken or weaponized.



Division 10 | Specialties

Handrails



Office of
Mental Health

General Notes

All handrails are subject to possible wedge ligature with a shoe or other object.

Installation Notes

Verify that all handrails are installed per the manufacturer's installation instructions. Proper installation is critical in order for tight tolerances between the multiple product pieces.

Sealant may be required to fill voids around the perimeter of handrails depending on installation substrate.

Additional Notes

The inside of handrails with continuous mounting brackets are susceptible to the collection of debris.

Caution Notes

Traditional code compliant handrails create obvious ligature opportunities.



Wallguard

www.wallguard.com

2021S Handrail

5-1/2" high, 12'-0" continuous security bracket and mounting system. Class A fire rating and ADA compliant. Provide manufacturer's continuous aluminum tube with laser cut 1/8" thick aluminum closure plates at corners and mechanically fastened. Colored cover shall be installed with 3M Fastbond 30 water based contact adhesive to prevent removal.

Caution: Cover is easily removable and can be broken or weaponized.



Division 10 | Specialties

Wall Protection

Installation Notes

Verify that wall protection is installed per the manufacturer's installation instructions. Proper installation is critical in order for tight tolerances between the multiple product pieces.

Sealant may be required to fill voids around the perimeter of wall protection depending on installation substrate.

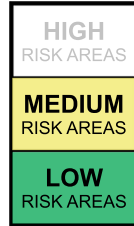

InPro Corporation

www.inprocorp.com

1500 Wall Guard

Impact resistant continuous rigid vinyl cover bumper mounted on a continuous aluminum retainer.

Note:

- 1500i, with retained clips, is not recommended for use.

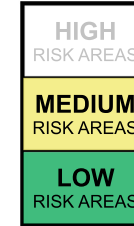

InPro Corporation

www.inprocorp.com

1600 Wall Guard

Impact resistant continuous rigid vinyl cover bumper mounted on a continuous aluminum retainer.

Note:

- 1600i, with retained clips, is not recommended for use.



Division 10 | Specialties

Toilet Accessories, Grab Bars

General Notes

Many grab bars are subject to possible wedge ligature with a shoe or other object. Grab bars should only be installed where required by code.

Installation Notes

Verify that all grab bars are installed per the manufacturer's installation instructions. Proper installation is critical in order for tight tolerances between the multiple product pieces.

Provide continuous blocking. Be attentive to potential moment arm issues on existing installations without continuous blocking.

Coordinate location of grab bars with concealed flushometer access panels.

Sealant may be required to fill voids around the perimeter of grab bars depending on the installation substrate.

Additional Notes

Specialty grab bars may be handed in only one direction when installed vertically.

Caution Notes

- Traditional code compliant grab bars create obvious ligature opportunities.
- ICRA notes potential infection control problem at end closure plates.
- Drainage holes at end caps create potential ligature opportunities with paper clips.



Behavioral Safety Products

www.besafeprod.com

GB730 Ligature-Resistant Grab Bar

Symmetrical (non-handed) design allows for mounting the grab bar in any direction; vertical, horizontal, or pitched installations.

Notes:

- Water drains off open end of grab bar and will result in water on the bathroom floor if configured incorrectly.



Kingsway Group

www.kingswaygroupusa.com

Grab Rail 270 Series

Horizontal and vertical mounting. Painted extruded aluminum, 600 mm long. Provide sealant at the full perimeter to prevent end to end looping.

Notes:

- Include "G" after model number when ordering to ensure that the required graspable length is provided.
- Water drains off open end of grab bar and will result in water on the bathroom floor if configured incorrectly.



Division 10 | Specialties

Toilet Accessories, Grab Bars

General Notes

Many grab bars are subject to possible wedge ligature with a shoe or other object. Grab bars should only be installed where required by code.



Installation Notes

Verify that all grab bars are installed per the manufacturer's installation instructions. Proper installation is critical in order for tight tolerances between the multiple product pieces.



Provide continuous blocking. Be attentive to potential moment arm issues on existing installations without continuous blocking.

Coordinate location of grab bars with concealed flushometer access panels.



Sealant may be required to fill voids around the perimeter of grab bars depending on the installation substrate.

Additional Notes

Specialty grab bars may be handed in only one direction when installed vertically.

Caution Notes

- Traditional code compliant grab bars create obvious ligature opportunities.
- ICRA notes potential infection control problem at end closure plates.
- Drainage holes at end caps create potential ligature opportunities with paper clips.

Northwest Specialty Hardware

www.northwestsh.com

NW Security Bar

Cascade Specialty Hardware

www.cascadesh.com

Safebar Grab Bar

Securing Cosmos

www.securingscosmos.com

811-S03 SafeSupport SR Safe-T Grab Bar

Specialty self-draining end caps are available from manufacturers and should be specified. Provide sealant at the full perimeter to prevent end to end looping.

Caution: Horizontal and vertical mounting are acceptable but may permit wedge ligature with a shoe or other object.



Willoughby Industries, Inc.

www.willoughby-ind.com

LRGB-X-ADA Series Ligature-resistant Grab Bar

Specialty self-draining end caps are available from manufacturers and should be specified. Provide sealant at the full perimeter to prevent end to end looping.

Caution: Horizontal and vertical mounting are acceptable but may permit wedge ligature with a shoe or other object.



Division 10 | Specialties

Toilet Accessories, Grab Bars

General Notes

Many grab bars are subject to possible wedge ligature with a shoe or other object. Grab bars should only be installed where required by code.



Installation Notes

Verify that all grab bars are installed per the manufacturer's installation instructions. Proper installation is critical in order for tight tolerances between the multiple product pieces.

Provide continuous blocking. Be attentive to potential moment arm issues on existing installations without continuous blocking.

Coordinate location of grab bars with concealed flushometer access panels.

Sealant may be required to fill voids around the perimeter of grab bars depending on the installation substrate.

Additional Notes

Specialty grab bars may be handed in only one direction when installed vertically.

Caution Notes

- Traditional code compliant grab bars create obvious ligature opportunities.
- ICRA notes potential infection control problem at end closure plates.
- Drainage holes at end caps create potential ligature opportunities with paper clips.

Whitehall Manufacturing

www.whitehallmfg.com

1109-1 24" Ligature-Resistant Grab Bar

Note: This product may allow end to end looping ligature.



Whitehall Manufacturing

www.whitehallmfg.com

1110-2 24" Ligature-Resistant Grab Bar

Note: This product may allow end to end looping ligature.



Whitehall Manufacturing

www.whitehallmfg.com

Best-Care WH1140 Ligature-Resistant ADA Compliant Grab Bar with V-Closure Strip

Note: Drainage holes permit ligatures.

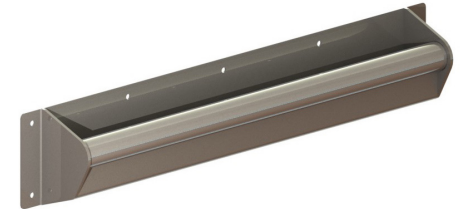

Division 10 | Specialties

Toilet Accessories, Grab Bars

General Notes

Many grab bars are subject to possible wedge ligature with a shoe or other object. Grab bars should only be installed where required by code.



Installation Notes

Verify that all grab bars are installed per the manufacturer's installation instructions. Proper installation is critical in order for tight tolerances between the multiple product pieces.

Provide continuous blocking. Be attentive to potential moment arm issues on existing installations without continuous blocking.

Coordinate location of grab bars with concealed flushometer access panels.

Sealant may be required to fill voids around the perimeter of grab bars depending on the installation substrate.

Additional Notes

Specialty grab bars may be handed in only one direction when installed vertically.

Caution Notes

- Traditional code compliant grab bars create obvious ligature opportunities.
- ICRA notes potential infection control problem at end closure plates.
- Drainage holes at end caps create potential ligature opportunities with paper clips.

American Specialties, Inc.

www.americanspecialties.com

0165 Grab Bar with Drain Holes

Note: This product may allow end to end looping ligature.



Securing Cosmos

www.securingscosmos.com

811-S38 SafeSupport SR Draining Grab Bar

Horizontal mounting.

Note: Drainage slot permits ligature.



Division 10 | Specialties

Toilet Accessories, General

General Notes

Some product categories offer few patient safe solutions that have been approved for use in NYS-OMH facilities. One such category is toilet accessories. Many manufacturers of soap dispensers, paper towel dispensers, hand dryers, and toilet tissue dispensers/holders market their products as appropriate for use in high risk environments. Upon testing many products, NYS-OMH has determined that they often present opportunities for self-harm.

Failure Modes

Because these product types dispense disposable products, many of them make use of slots or holes. This allows for wedging and tying, providing opportunities for downward ligature. Hand dryers inherently present risk, as they rely on unobstructed airflow to function. Hand dryers that have been accepted by OMH dispense and exhaust air as inconspicuously as possible, and resist looping over the top of the device.

Infection Control

There exist some inherent problems with options that present a patient safe solution, one of which is risk of infection. Paper towel and toilet tissue shelves and holders which do not secure the disposable products allow it to fall on the floor, rendering it contaminated. Users cannot be prevented from using the contaminated products; this leads many facilities to disallow the use of shelves and holders.

Best In Class

It is the responsibility of each facility to determine, based on their own risk assessment, how best to address these needs. Some options in this Standard will appeal more than others based on past experience and knowledge of a particular patient population. The decision to utilize a product noted as “Rejected” or “Use with Caution” may in fact be the best solution for a facility, provided that it understands the risks involved and has a plan to manage those risks as best as possible.

Division 10 | Specialties

Toilet Accessories, Soap Dispensers

General Notes

Best practice advocates the use of recessed toilet accessories.

Performance Criteria

Quality control of toilet accessories is important and often difficult to control. Samples should be requested as part of the submittal process.

Caution Notes

Soap dispensers with flat tops or push levers provide a loopable ligature.



Behavioral Safety Products

www.besafeprod.com

SD750 Ligature-Resistant Soap Dispenser

Powder coated all metal construction with a rounded, smooth-edged design.

Caution: Dispenser area allows for wedging opportunities.

Notes:

- Specify stainless steel cam lock for installation in wet areas.



Gojo Industries

www.gojo.com

LTX Behavioral Health Dispensing System

Stainless steel Soap dispensing unit specifically designed for behavioral health environments with delayed time output, inhibited access interior, and sloped and rounded exterior.

Caution: Dispenser area allows for wedging opportunities.



Division 10 | Specialties

Toilet Accessories, Soap Dispensers

General Notes

Best practice advocates the use of recessed toilet accessories.

Performance Criteria

Quality control of toilet accessories is important and often difficult to control. Samples should be requested as part of the submittal process.

Caution Notes

Soap dispensers with flat tops or push levers provide a loopable ligature.



Kingsway Group
www.kingswaygroupusa.com

KG07 Manual Soap Dispenser
 Stainless steel surface mounted liquid soap dispenser. Soap is manually dispensed with a push button mechanism. The soap dispenser has an inner cassette that slides downward and houses a plastic refillable cartridge.

Caution: Dispenser area allows for wedging opportunities.



Symmetry Hand Hygiene
www.symmetryhandhygiene.com

990114501 | 99014601 Resilient Hand Hygiene Dispenser
 Die cast aluminum dispenser. Soap is manually dispensed with a push button.

Caution: Dispenser area allows for wedging opportunities.



990114501
 White with Alpine Gray Lever

99014601
 White with Empathy Light Blue Lever

Division 10 | Specialties

Toilet Accessories, Soap Dispensers

General Notes

Best practice advocates the use of recessed toilet accessories.

Performance Criteria

Quality control of toilet accessories is important and often difficult to control. Samples should be requested as part of the submittal process.

Caution Notes

Soap dispensers with flat tops or push levers provide a loopable ligature.



Gojo Industries

www.gojo.com

ADX-12 Security Enclosure

Note: This product provides wedging opportunities.



American Specialties, Inc.

www.americanspecialties.com

5002 Soap Dispenser

Notes:

- Product has sharp components.
- Provides multiple ligature points.
- Projects 1/2" from face of wall.



American Specialties, Inc.

www.americanspecialties.com

9326 Soap Dispenser

Note: This product provides a loopable ligature.



Bobrick

www.bobrick.com

B-26607 Soap Dispenser

Note: This product provides a loopable ligature.



Division 10 | Specialties

Toilet Accessories, Soap Dispensers



General Notes

Best practice advocates the use of recessed toilet accessories.



Performance Criteria

Quality control of toilet accessories is important and often difficult to control. Samples should be requested as part of the submittal process.

Caution Notes

Soap dispensers with flat tops or push levers provide a loopable ligature.

Opsbox/Archer Manufacturing

www.vandalproof.org

Ops 1-Touch Dispenser Vandal Proof Foaming Dispenser

Notes:

- Activator allows for wedging opportunities.
- Provides ligature points.



Division 10 | Specialties

Toilet Accessories, Paper Towel Holders & Dispensers

General Notes

Best practice advocates the use of recessed toilet accessories.

Performance Criteria

Quality control of toilet accessories is important and often difficult to control. Samples should be requested as part of the submittal process.

Installation Notes

Recessed paper towel shelves require blocking on sides of shelf at wall studs and shall be mechanically fastened through to blocking.

Specify wall thickness as required.



Behavioral Safety Products

www.besafeprod.com

RS780 Ligature Resistant Recessed Shelf

Stainless steel with powder coated white finish. Install with tamper-resistant fasteners. Provide tamper-resistant sealant at flange perimeter.

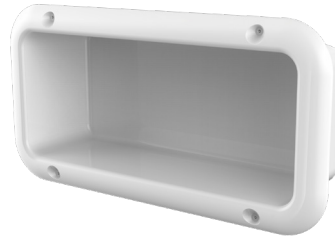

Swanstone

www.swanstone.com

AS-1075 Recessed Accessory Shelf

Solid surface accessory shelf. Install with strict adherence to manufacturer's installation instructions. Provide tamper resistant sealant at perimeter of accessory shelf trim.



Kingsway Group

www.kingswaygroupusa.com

KG12 Anti-Ligature Recessed Washroom Shelf

Stainless steel recessed shelf with self draining base. Install with tamper resistant fasteners. Provide tamper-resistant sealant at flange perimeter.

Note: Specify with powder coated finish.

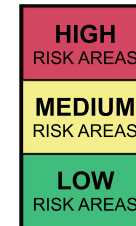

Whitehall Manufacturing

www.whitehallmfg.com

Best-Care WH1820FA Recessed Shelf

16 gauge type 304 stainless steel with a satin finish or powder coated white finish. Install with tamper-resistant fasteners. Provide tamper-resistant sealant at flange perimeter.



Division 10 | Specialties

Toilet Accessories, Paper Towel Holders & Dispensers

General Notes

Best practice advocates the use of recessed toilet accessories.

Performance Criteria

Quality control of toilet accessories is important and often difficult to control. Samples should be requested as part of the submittal process.

Installation Notes

Recessed paper towel shelves require blocking on sides of shelf at wall studs and shall be mechanically fastened through to blocking.

Specify wall thickness as required.



Behavioral Safety Products

www.besafeprod.com

Ligature-Resistant Paper Towel Dispenser PH235

Surface mount paper towel dispenser. Polycarbonate finish. Accepts center-pull paper towels.

Caution:

- Dispenser area allows for wedging opportunities.
- A difficult but possible side ligature opportunity exists with this product. A rigid implement can wedge a shoelace between the enclosure and backplate.



Behavioral Safety Products

www.besafeprod.com

Ligature-Resistant Paper Towel Dispenser #PH240

Semi-recessed paper towel dispenser. Polycarbonate finish. Accepts center-pull paper towels.

Caution:

- Dispenser area allows for wedging opportunities.



Division 10 | Specialties

Toilet Accessories, Paper Towel Holders & Dispensers

General Notes

Best practice advocates the use of recessed toilet accessories.

Performance Criteria

Quality control of toilet accessories is important and often difficult to control. Samples should be requested as part of the submittal process.



Georgia-Pacific

www.gppro.com

59466A enMotion Semi-Recessed Paper Towel Dispenser

Semi-recessed automated touch-less paper towel dispenser.

Notes:

- Loopable flat top allows ligature.
- Serrated metal strip allows wedging opportunity for downward ligature and potential for weaponization.



Georgia-Pacific

www.gppro.com

56620 Combination Folded Paper Towel Dispenser

Combination C-fold/multi-fold paper towel dispenser.

Notes:

- Loopable flat top allows ligature.
- Slotted dispenser allows wedging opportunity for downward ligature.



Division 10 | Specialties

Toilet Accessories, Paper Towel Holders & Dispensers

General Notes

Best practice advocates the use of recessed toilet accessories.

Performance Criteria

Quality control of toilet accessories is important and often difficult to control. Samples should be requested as part of the submittal process.



American Specialties, Inc.

www.americanspecialties.com

0457 Recessed Paper Towel Dispenser

22 gauge type 304 stainless steel with a satin finish.

Note: Slotted dispenser allows wedging opportunity for downward ligature.

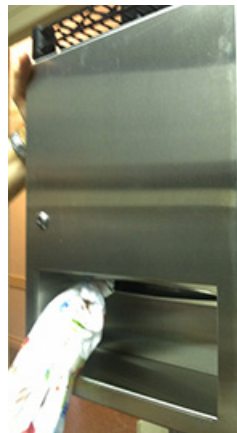

Opsbox/Archer Manufacturing

www.vandalproof.org

Supreme Multi-Purpose Paper Towel Dispenser

Notes:

- Slot allow for wedging opportunities.
- Provides ligature points.



Division 10 | Specialties

Toilet Accessories, Hand Dryers

General Notes

Best practice advocates the use of recessed toilet accessories.

Performance Criteria

Quality control of toilet accessories is important and often difficult to control. Samples should be requested as part of the submittal process.



World Dryer

www.worlddryer.com

SLIMdri Hand Dryer

Surface-mounted ADA compliant hand dryer.

Caution: Vent area allows for looping opportunities.



American Specialties, Inc.

www.americanspecialties.com

0198MH SafeDri Recessed Mounted Sensor Hand Dryer

18 gauge type 304 stainless steel cover and hand dryer chamber over automatic hand dryer with infrared sensor. Air intake pulls from stud space or plenum.



Division 10 | Specialties

Toilet Accessories, Toilet Tissue Holders & Dispensers

General Notes

Best practice advocates the use of recessed toilet accessories.

Coordinate toilet tissue roll size with holder.

Performance Criteria

Quality control of toilet accessories is important and often difficult to control. Samples should be requested as part of the submittal process.

Installation Notes

Front mounted models should be installed with tamper-resistant fasteners. Back mounted models can only be installed on accessible chase walls.

Caution Notes

- Potential hazard with loose toilet tissue rolls which can be lodged in toilets.
- Potential infection control issue with loose toilet tissue rolls which can be easily dropped on the floor.
- Toilet tissue holders with spindles may allow a downward ligature by tying off to the spindles if they don't release when more than the acceptable amount of force is applied (greater than 11 lbs.).



American Specialties, Inc.
www.americanspecialties.com

110-13 Recessed Toilet Paper Roll Holder (Front Mounted)

14 gauge type 304 stainless steel with a satin finish.



Whitehall Manufacturing
www.whitehallmfg.com

1840-FA Recessed Toilet Paper Roll Holder (Front Mounted)

14 gauge type 304 stainless steel with a satin finish or white enamel finish.



Division 10 | Specialties

Toilet Accessories, Toilet Tissue Holders & Dispensers

General Notes

Best practice advocates the use of recessed toilet accessories.

Coordinate toilet tissue roll size with holder.

Performance Criteria

Quality control of toilet accessories is important and often difficult to control. Samples should be requested as part of the submittal process.

Installation Notes

Front mounted models should be installed with tamper-resistant fasteners. Back mounted models can only be installed on accessible chase walls.

Caution Notes

- Potential hazard with loose toilet tissue rolls which can be lodged in toilets.
- Potential infection control issue with loose toilet tissue rolls which can be easily dropped on the floor.
- Toilet tissue holders with spindles may allow a downward ligature by tying off to the spindles if they don't release when more than the acceptable amount of force is applied (greater than 11 lbs.).



Cascade Specialty Hardware

www.cascadesh.com

C-400 Safety Toilet Paper Holder

Caution: Break away weight is 18 lbs and exceeds recommended.

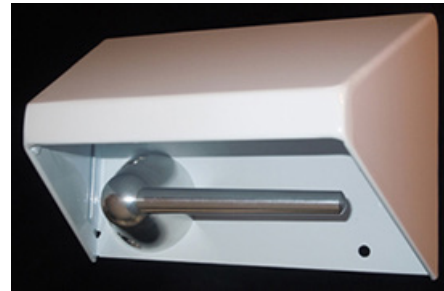

Kingsway Group

www.kingswaygroupusa.com

Recessed Toilet Roll Holder KG13

Caution: Break away weight is 16 lbs and exceeds recommended.

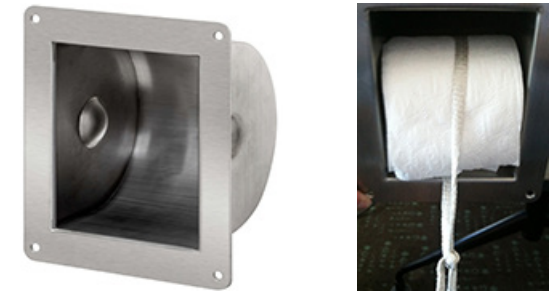

Whitehall Manufacturing

www.whitehallmfg.com

Best-Care WH1845B Ligature-Resistant Spindle Button Recessed Toilet Paper Holder

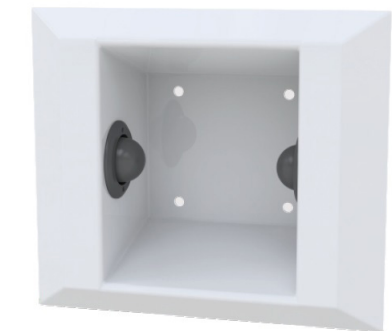

Division 10 | Specialties

Toilet Accessories, Toilet Tissue Holders & Dispensers

General Notes

Best practice advocates the use of recessed toilet accessories.

Coordinate toilet tissue roll size with holder.

Performance Criteria

Quality control of toilet accessories is important and often difficult to control. Samples should be requested as part of the submittal process.

Installation Notes

Front mounted models should be installed with tamper-resistant fasteners. Back mounted models can only be installed on accessible chase walls.

Caution Notes

- Potential hazard with loose toilet tissue rolls which can be lodged in toilets.
- Potential infection control issue with loose toilet tissue rolls which can be easily dropped on the floor.
- Toilet tissue holders with spindles may allow a downward ligature by tying off to the spindles if they don't release when more than the acceptable amount of force is applied (greater than 11 lbs.).



American Specialties, Inc.

www.americanspecialties.com

0262 Surface Mounted Folded Toilet Tissue Cabinet

Note: Slotted dispenser allows wedging opportunity for downward ligature.

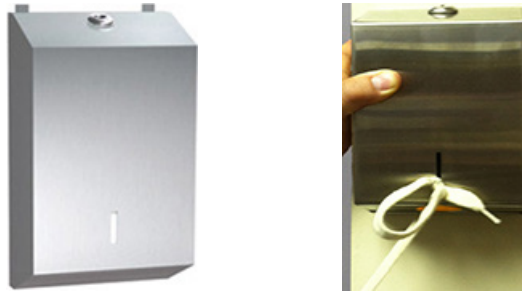

Bobrick

www.bobrick.com

B-5288 Surface Mounted Multi-Roll Toilet Tissue Dispenser

Note: Plastic spindle can create a downward ligature and can be broken into small shards and weaponized.



Bradley Corporation

www.bradleycorp.com

SA12 Recessed Toilet Tissue Roll Holder (Front Mounted)

16 gauge type 304 stainless steel with a satin finish.

Note: Joint between rim and faceplate permits looping.



Kingsway Group

www.kingswaygroupusa.com

Surface Mounted Toilet Tissue Dispenser KG04

Note: Slotted dispenser allows wedging opportunity for downward ligature.

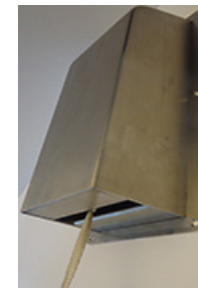

Division 10 | Specialties

Toilet Accessories, Toilet Tissue Holders & Dispensers

General Notes

Best practice advocates the use of recessed toilet accessories.

Coordinate toilet tissue roll size with holder.

Performance Criteria

Quality control of toilet accessories is important and often difficult to control. Samples should be requested as part of the submittal process.

Installation Notes

Front mounted models should be installed with tamper-resistant fasteners. Back mounted models can only be installed on accessible chase walls.

Caution Notes

- Potential hazard with loose toilet tissue rolls which can be lodged in toilets.
- Potential infection control issue with loose toilet tissue rolls which can be easily dropped on the floor.
- Toilet tissue holders with spindles may allow a downward ligature by tying off to the spindles if they don't release when more than the acceptable amount of force is applied (greater than 11 lbs.).



Morcon, Inc.

MO-M1007 Morcon Surface Mounted Metal Dispenser

Note: Frame and spindles create an opportunity for downward ligature.

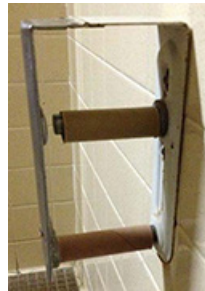

Northwest Specialty Hardware

www.northwestsh.com

NW 611 Toilet Paper Holder

Note: Spindle can be tied off to form a ligature point.



Division 10 | Specialties

Toilet Accessories, Mirrors

General Notes

Only polycarbonate glazing is recommended for use in patient bathrooms.



Sabic Innovative Plastics

www.sabic.com/en

Royal Adhesives & Sealants

www.royaladhesives.com

Frameless Polycarbonate Wall-to-Wall Mirror

Lexan Dura-Mir, 0.25" (6 mm) polycarbonate. Install from wall-to-wall and from top of sink backsplash to ceiling, using adhesive recommended by polycarbonate manufacturer.

Note: Provide tamper-resistant sealant at mirror perimeter. Sealant joint shall not exceed 1/8". At joints that exceed 1/8", provide a metal or solid surface trim piece to conceal the edge of polycarbonate mirror.

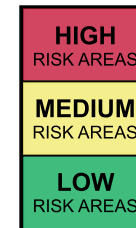

Behavioral Safety Products

www.besafeprod.com

Ligature-Resistant Framed Stainless Steel Mirror FM760 (18"x24") | FM770 (24"x36")

Polished stainless steel mirror with #8 finish. Powder coated (white) stainless steel frame.

Caution: Provide tamper-resistant sealant at full perimeter of frame.



Behavioral Safety Products

www.besafeprod.com

Ligature-Resistant Wood Framed Stainless Steel Mirror FM160 (18"x24")

Polished stainless steel mirror with #8 finish. Wood frame available in birch, mahogany & walnut finish.

Caution: Provide tamper-resistant sealant at full perimeter of frame.



Division 10 | Specialties

Toilet Accessories, Mirrors

General Notes

Only polycarbonate glazing is recommended for use in patient bathrooms.



Norix

www.norix.com

MFSST-REC-1620 Wall Mirror - Rectangle

Stainless steel mirror with bright annealed or #8 mirror finish on one side. Powder coated 1"x1/4" steel frame with recessed fastening holes.

Caution: Provide tamper-resistant sealant at full perimeter of frame.



Whitehall Manufacturing

www.whitehallmfg.com

WH1813-SPLT Ligature-Resistant 13"x23.625" Stainless Steel Mirror

Type 400-series polished stainless steel mirror finish with Type 304 stainless steel frame powder coated white.

Caution: Provide tamper-resistant sealant at full perimeter of frame.



Whitehall Manufacturing

www.whitehallmfg.com

WH1811-SPLT Ligature-Resistant 13"x17" Stainless Steel Mirror

Type 400-series polished stainless steel mirror finish with Type 304 stainless steel frame powder coated white.

Caution: Provide tamper-resistant sealant at full perimeter of frame.



Division 10 | Specialties

Toilet Accessories, Mirrors

General Notes

Only polycarbonate glazing is recommended for use in patient bathrooms.



American Specialties, Inc.

www.americanspecialties.com

0600 Angle Frame Mirror

18 gauge type 304 stainless steel with satin finish. Concealed hanging bracket that locks onto top and bottom of frame by tamper-resistant screws.

Note: Ligature point can be established across the top of mirror due to squared edge and finish of stainless steel frame.



Oddball Industries

www.oddballindustries.com

SP-8 Mirror Guard

Note: Mirror guard has sharp edges and does not sit flush to profile of mirror.



Division 10 | Specialties

Window Treatments

General Notes

Users shall perform a risk assessment to determine their options for shower and privacy curtains.

Specify breathable fabric material for shower and privacy curtains.

Installation Notes

Recessed ceiling track shall run continuously between walls. Surface-mounted ceiling track shall run continuously between walls, or be installed with secure end caps. Fill all joints between sections of track with tamper-resistant sealant to reduce opportunities for ligation.

Caution Notes

- End caps can create opportunity for a wedge ligation.
- A looping point can be created in curtain tracks when an object, such as a penny, is inserted into the track.
- The breakaway weight for curtain carriers may exceed the limits at which self-harm can be induced. Carriers can be ganged together to increase the release weight.
- Track system may be weaponized if subjected to severe abuse and dismantled.

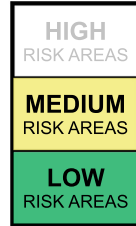

InPro Corporation

www.inprocorp.com

Clickeze Ultra Cubicle Track

Extruded aluminum track provides heavy-duty strength. For use with Clickeze accessories.

Clickeze Whisper Cubicle Track

Extruded PVC track allows for noise reduction during curtain movement. For use with Clickeze accessories.

Ultra Track



Whisper Track

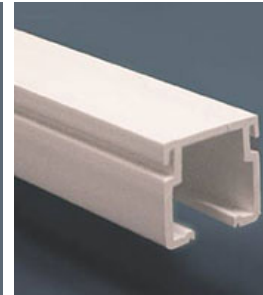

Caution: Potential looping point at curtain tracks.

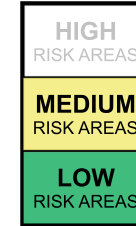
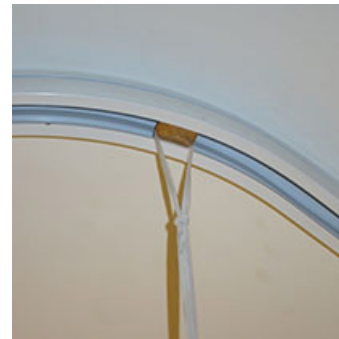

InPro Corporation

www.inprocorp.com

Clickeze Pop Out Carrier

Hook on carrier releases, allowing the curtain to fall, and disengages at approximately 10 lbs. of pressure. For use with both Clickeze Ultra and Whisper Curtain Tracks.



Division 10 | Specialties

Window Treatments



General Notes

Users shall perform a risk assessment to determine their options for shower and privacy curtains.

Specify breathable fabric material for shower and privacy curtains.

Installation Notes

Recessed ceiling track shall run continuously between walls. Surface-mounted ceiling track shall run continuously between walls, or be installed with secure end caps. Fill all joints between sections of track with tamper-resistant sealant to reduce opportunities for ligation.

Caution Notes

- End caps can create opportunity for a wedge ligation.
- A looping point can be created in curtain tracks when an object, such as a penny, is inserted into the track.
- The breakaway weight for curtain carriers may exceed the limits at which self-harm can be induced. Carriers can be ganged together to increase the release weight.
- Track system may be weaponized if subjected to severe abuse and dismantled.

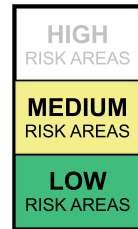

Oddball Industries

www.oddballindustries.com

HealSafe Interiors J-Trac Curtain Rail SP-2 (Wall Mount or Ceiling Mount)

Hook on carrier is designed to clip onto the J-Trac curtain rail and releases from track when downward pressure is applied. The curtain rail can be ceiling or wall-mounted.

Caution: A wall-mounted installation can hold a downward ligature of 20lbs. when several hooks are ganged together.

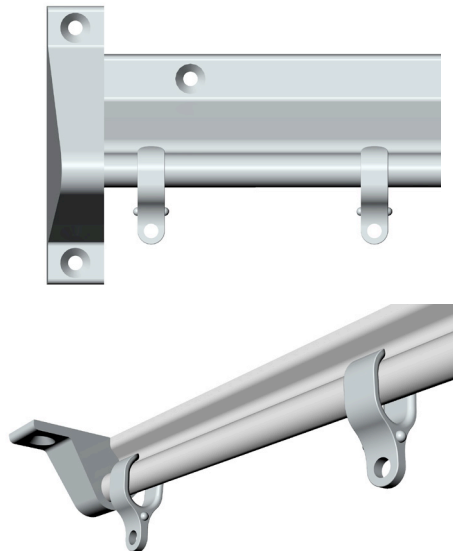

Construction Specialties, Inc.

www.c-sgroup.com

Breakaway Carrier #975P

Hook on carrier is designed to pop out of the axle when approximately 22 lbs. of pressure is applied to the hook, and can be reused.



Division 10 | Specialties

Window Treatments



General Notes

Users shall perform a risk assessment to determine their options for shower and privacy curtains.

Specify breathable fabric material for shower and privacy curtains.

Installation Notes

Recessed ceiling track shall run continuously between walls. Surface-mounted ceiling track shall run continuously between walls, or be installed with secure end caps. Fill all joints between sections of track with tamper-resistant sealant to reduce opportunities for ligature.

Caution Notes

- End caps can create opportunity for a wedge ligature.
- A looping point can be created in curtain tracks when an object, such as a penny, is inserted into the track.
- The breakaway weight for curtain carriers may exceed the limits at which self-harm can be induced. Carriers can be ganged together to increase the release weight.
- Track system may be weaponized if subjected to severe abuse and dismantled.



Imperial Fastener Company

www.imperialfastener.com

IFC-69 Break-A-Way Track & IFC-79 Break-A-Way Track

The IFC-69 ceiling mounted and IFC-79 wall-mounted tracks are used with “Safety Tabs” that attach to box pleated window draperies or shower curtains.

Notes:

- Velcro on “Safety Tabs” creates a tie off ligature point.
- IFC-79 wall-mounted curtain track can be continuously looped end to end.

IFC-69 Break-A-Way Track



IFC-79 Break-A-Way Track



WebbShade

www.inprocorp.com

WebbLok Shades

The IFC-69 ceiling mounted and IFC-79 wall-mounted tracks are used with “Safety Tabs” that attach to box pleated window draperies or shower curtains.

Note: This product provides many potential ligature points.





Behavioral Safety Products

www.besafeprod.com

Ligature-Resistant Art Frame #AF550

Multiple frame sizes available. Select prints from on-line library of 60 prints, to be matted like a typical picture frame, but positioned behind 1/8" polycarbonate glazing. Follow manufacturer's installation instructions.

Caution: Provide tamper-resistant sealant at full perimeter of frame.

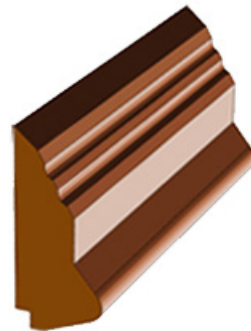
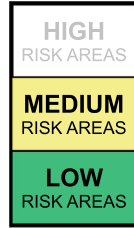

Custom Design Frameworks

www.customdesignframeworks.com

8 1/2 x 11 Custom Wood Frames with Ligature-Resistant Profile

Multiple wood types and finishes available. Specify with standard 3/16" polycarbonate glazing.

Caution: Provide tamper-resistant sealant at full perimeter of frame.

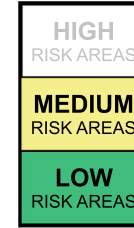

Division 10 | Specialties

Cabinet Hardware

Performance Criteria

For cabinet and dresser doors and drawers, provide either ligature-resistant pulls or integral recessed flush pulls.

Installation Notes

Provide non-loopable ligature-resistant, tamper-resistant security grade hardware. Ensure cabinet hinge pin is not removable (tack weld or cap).

Caution Notes

Single point fasteners pose twist off hazard. Specify set screw or embed fastener in pick proof sealant.



Accurate Lock & Hardware

www.accuratelockandhardware.com

CP-CAB Crescent Cabinet Pull



Architectural Builders Hardware Mfg. Inc.

www.abhmfg.com

1931 Cabinet Pull



Division 10 | Specialties

Cabinet Hardware

Performance Criteria
 For cabinet and dresser doors and drawers, provide either ligature-resistant pulls or integral recessed flush pulls.

Installation Notes
 Provide non-loopable ligature-resistant, tamper-resistant security grade hardware. Ensure cabinet hinge pin is not removable (tack weld or cap).

Caution Notes
 Single point fasteners pose twist off hazard. Specify set screw or embed fastener in pick proof sealant.



Kingsway Group
www.kingswaygroupusa.com

KG31 Anti-Ligature Easygrip Pull Handle Bolt Fixed



Kingsway Group
www.kingswaygroupusa.com

KG50 Anti-Ligature Small Cupped Pull Handle



Kingsway Group
www.kingswaygroupusa.com

KG41 Anti-Ligature Ergogrip Handle Bolt Fixed



Kingsway Group
www.kingswaygroupusa.com

KG62 Anti-Ligature Classic Grip Cabinet Pull Handle



Division 10 | Specialties

Cabinet Hardware

Performance Criteria

For cabinet and dresser doors and drawers, provide either ligature-resistant pulls or integral recessed flush pulls.

Installation Notes

Provide non-loopable ligature-resistant, tamper-resistant security grade hardware. Ensure cabinet hinge pin is not removable (tack weld or cap).

Caution Notes

Single point fasteners pose twist off hazard. Specify set screw or embed fastener in pick proof sealant.



Hafele

www.hafeleamericas.com

158.80 Flush Pull

Note: Recess creates an opportunity for wedging.



Top Knobs Decor

www.topknobsdecor.com

M495 Somerset Cup Pull

Note: Recess creates an opportunity for wedging.



Sugatsune America, Inc.

www.sugatsune.com

UT-105/S Cabinet Pull

Notes:

- The cabinet pull is installed by pressure fit. Therefore it can be forcibly removed and parts ingested.
- There are also looping ligature opportunities between the pull and the substrate.



Division 10 | Specialties

Signage

Installation Notes

Signage systems should be mechanically fastened to substrate with tamper-resistant fasteners. Double stick tape and Velcro are not acceptable.

Provide tamper resistant sealant at perimeter if signage is not tight to wall surface.



2/90 Sign Systems

www.290signs.com

SafeCare Signage

Thermoplastic frame, fully adhered to thermoplastic backpanel; clear polycarbonate insert lens. Mechanically fasten to blocking with tamper-resistant fasteners.

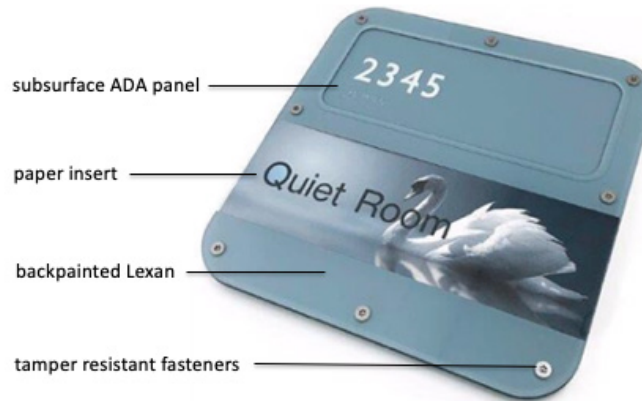
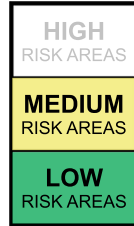

King Architectural Products

www.king-ap.com

KMS Series Signage

Tamper-resistant locking; Top, bottom, panel profiles and copy covers are held in place by manufacturer's standard concealed locking pin. Specify two locking pins per sign.

Caution: Edges of metal profile pieces can be sharp.

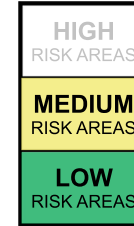

Division 10 | Specialties

Signage

Installation Notes

Signage systems should be mechanically fastened to substrate with tamper-resistant fasteners. Double stick tape and Velcro are not acceptable.



2/90 Sign Systems

www.290signs.com

Flxsigns

Note: The Flxsign is highly susceptible to vandalism and can potentially be used as a weapon.



Division 10 | Specialties

Fire Extinguisher Cabinets

General Notes

Locate only in supervised areas.

Installation Notes

See NYS-OMH Guidelines for strategies to maintain wall assembly fire ratings at recessed cabinets.

Code Notes

NFPA 10 requires locking fire extinguisher cabinets to include a “means of emergency access”. Manufacturers interpret this in various ways, including:

- Full lock with staff assigned keys.
- Break-away latch/lock with resettable tongue.
- Break-away latch/lock with non-resettable tongue.

Carefully review non-resettable products before specifying, as actual damage may be caused to the latch/lock mechanism during emergency access. Repair may be simple or complex depending on the specific product.

Caution Notes

Fire extinguisher cabinets are tested primarily for abuse-resistance and may be loopable at cabinet/door joint.



Larsen’s Manufacturing Company

www.larsensmfg.com

Architectural Series 2712 Fire Extinguisher Cabinet

Stainless steel tub with a continuous hinge. Specify fully recessed cabinet with flat trim, or semi-recessed cabinet with rolled edge trim & door without handle. Specify mortise lock with keyed cylinder.



Larsen’s Manufacturing Company

www.larsensmfg.com

DECS 2409-R4 Fire Extinguisher Cabinet

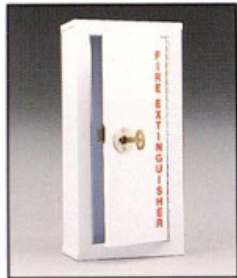

Activar Construction Products Group, Inc.

www.activarcpg.com

JL Industries Cosmopolitan Series Fire Extinguisher Cabinet

Note: Cabinet quality is not abuse or tamper-resistant and presents many sharp edges.



Division 10 | Specialties

Wall Device Covers



ARSCO Manufacturing Co.

www.arscomfg.com

Anti-ligature Thermostat Cover with Lock ACM0001-01A



Caution: Provide tamper-resistant sealant
at full perimeter of device.

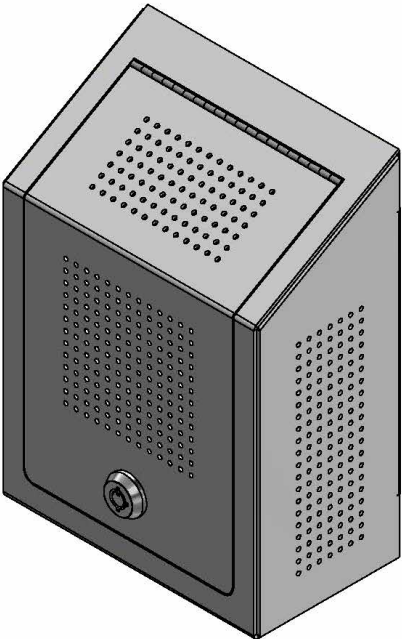

Division 12 | Furnishings



General Notes

Furniture with doors and drawers, such as wardrobes and dressers, will pose a potential ligature risk. Since there are no viable ligature-resistant solutions, it is highly recommended that doors and drawers are not provided for wardrobes, dressers, closet units, etc. unless their use is regulated by staff controlled locks. When considering if the use of wardrobes, dressers or closet units is desired or appropriate, best practice requires each new facility to complete a risk assessment for all spaces and furnishings. Patient privacy rights may also inform decisions about the need for specific furnishings.

Doors & Drawers Guidelines

- Provide locks for all doors and drawers, allowing staff to control access by at-risk patients when necessary.
- Provide doors with continuous hinges and hospital tips.
- Provide doors with recessed ligature-resistant finger pulls. If available, continuous integral finger pulls can also be provided.
- Provide drawers with recessed ligature-resistant finger pulls, stops, and locks.
- For high risk patients, consider the use of built-in closets with door top ligature sensors.

Wardrobe & Closet Unit Guidelines

- Recess wardrobes and closet units, or make continuous to underside of ceilings or soffits above.
- When it's not possible to make recessed units or make them continuous to underside of ceilings or soffits above, provide sloped tops.
- Provide collapsible coat hooks. Closet rods and j-bars are not acceptable.
- Requirements of the 2018 FGI Guidelines state: "Shelves for folded garments shall be used instead of arrangements for hanging garments."

Platform Bed Guidelines

- NYS-OMH has the following platform bed requirements:
- Beds must be platform type with flush side panels, headboards and footboards, with no overlapping lips between members.
- Platform beds shall be six-sided and have an enclosed bottom, or be five-sided and bolted to the floor.
- Provide solid wood or 3/4" plywood panels with veneer. Particleboard and plastic laminate are not acceptable.
- All wood members, both exposed and internal, shall be sealed with three layers of polyurethane.
- Internal construction shall consist of at least two intermediate supports. Acceptable support materials are wood and metal.
- All top and edge joints shall be sealed with tamper-resistant sealant.
- Provide no exposed fasteners, except when fastening bed to the floor.
- Glides and adjustable feet are not acceptable. Felt pads only.
- Exercise caution with platform beds that have restraints. These should be removed in all patient rooms unless one-on-one supervision is provided.
- Each facility must perform their own risk assessment to evaluate all products.

Manufacturers must be able to customize their bed construction to comply with all NYS-OMH platform bed requirements. Beds that do not comply will be rejected by NYS-OMH.

Division 21 | Fire Suppression



Division 21 | Fire Suppression Sprinklers

General Notes
Minimize removable parts.

Installation Notes
Specify no accessible parts that activate the sprinkler system when vandalized.



Tyco Fire Protection Products

www.tyco-fire.com

Raven Institutional Sprinklers
Pendant and horizontal sidewall heads. Standard, Quick Response & Extended Coverage. Stainless steel escutcheons available for installation in wet or damp areas.

Caution: Protective center cap can be removed upon severe tampering. Once removed, sprinkler head is susceptible to looping ligature.



Tyco Fire Protection Products

www.tyco-fire.com

Model TFP PH2 Sprinklers

Reliable Automatic Sprinkler Co., Inc.
www.reliablesprinkler.com

Model XL Quick Response Institutional Sprinkler

- Cautions:**
- A portion of the sprinkler head projects below the sprinkler head enclosure and is accessible to patients; tampering may activate sprinkler.
 - Removable parts create a potential safety hazard for ingestion and weaponization.
 - Break away weight is 50 lbs. and exceeds recommended.



Division 21 | Fire Suppression Sprinklers

General Notes

Minimize removable parts.

Installation Notes

Specify no accessible parts that activate the sprinkler system when vandalized.



Viking Group Inc.

www.vikinggroupinc.com

VK410 Pendant & VK412 Sidewall Institutional Flush Sprinklers

Note: The heat sensor projects below the sprinkler head enclosure and is accessible to patients. Damage to the heat sensor activates the system.



Division 22 | Plumbing



Division 22 | Plumbing

Lavatory Assemblies, General

General Notes

Lavatories in the following section are specified as systems. Individual components, used either independently of the system they are specified with, or combined with other systems, may not be ligature-resistant. Specifiers should take care to utilize products in concert to create systems that are safe for installation condition (e.g. in a niche as opposed to freestanding) and combinations of components that make a functional and safe system. These components include:

- Activators & Actuators
- Basins
- Countertops
- Faucets
- Fixtures
- Mirrors
- Niche Lavatories
- Pipe Enclosures

Ligature

Only fixed strainers should be used. Do not use pop-up drains. Care should be taken to specify ligature-resistant strainers.

Appearance

Facilities are encouraged to utilize lavatories and toilets made of materials other than stainless steel that support a therapeutic environment. If stainless steel fixtures are preferred by a facility, they should be specified with a powder coated finish.

Division 22 | Plumbing

Lavatory Assemblies

Code Notes
Provide ADA compliant handicapped accessible lavatory assembly configurations where required.



NYS-OMH Standard Lavatory Assembly

Custom Solid Surface Lavatory with Integral Sink Bowl & Pipe Enclosure

Niche mounted solid surface vanity counter with integral solid surface sink bowl and deck mounted ligature-resistant faucet. Removable integral solid surface pipe enclosure below mounted with tamper-resistant fasteners. Provide lavatory basin without overflow.

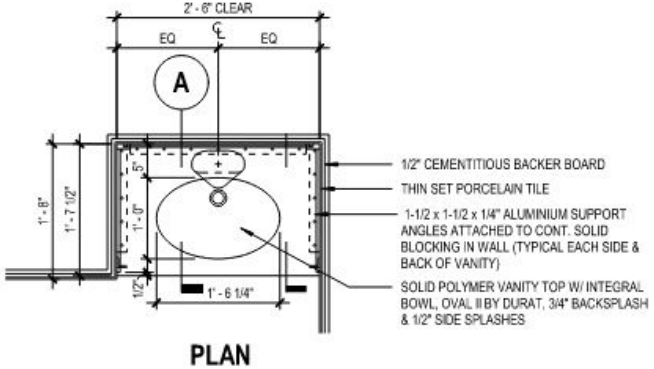
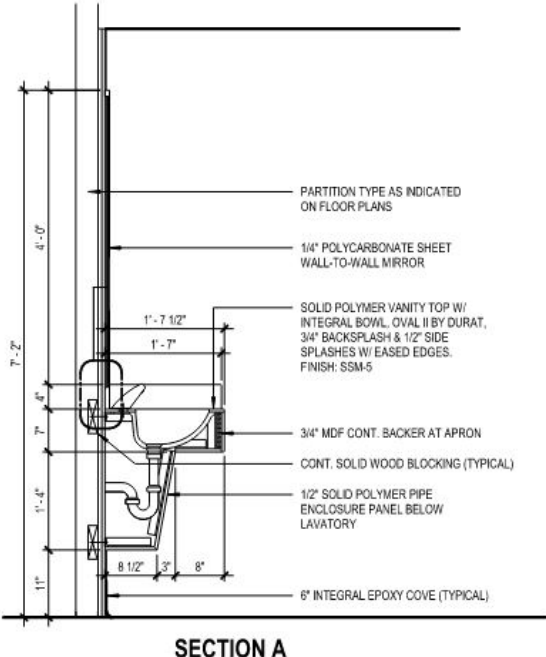
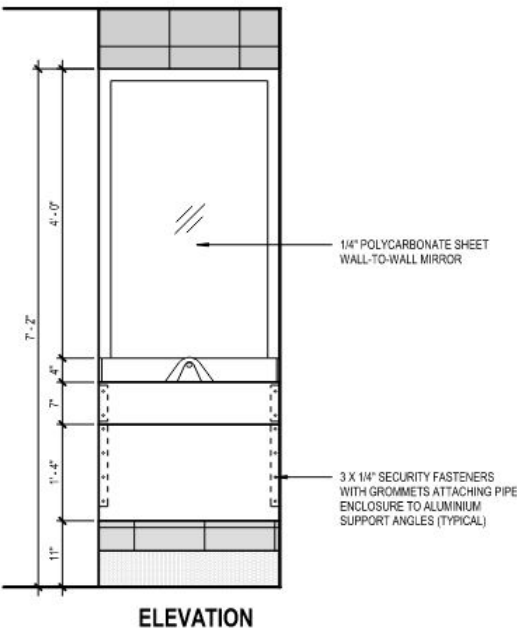

Division 22 | Plumbing

Lavatory Assemblies

Code Notes
Provide ADA compliant handicapped accessible lavatory assembly configurations where required.



American Standard

www.americanstandard-us.com

Lucerne 0355.012

Wall hung, vitreous china sink.

Note: A pipe enclosure, complying with ANSI 117.1, is required with this wall hung sink to conceal exposed plumbing piping.

Caution: A difficult but possible ligature opportunity may exist with this product. A series of shoelaces tied together may be looped over the lavatory and pulled back toward the support wall under the pipe enclosure.



Behavioral Safety Products

www.besafeprod.com

Ligature-Resistant Solid Surface Lavatory #ET720

Shown with pipe enclosure, which comes standard, and deck-mounted dual-temp push-button faucet, sold separately.

Caution: A difficult but possible ligature opportunity exists with this product. A series of shoelaces tied together may be looped over the lavatory and pulled back toward the support wall under the pipe enclosure.



Division 22 | Plumbing

Lavatory Assemblies



Code Notes

Provide ADA compliant handicapped accessible lavatory assembly configurations where required.

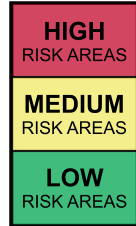

Whitehall Manufacturing

www.whitehallmfg.com

WH3775 Solid Surface Wall-Hung Lavatory

Shown with fully accessible powder-coated stainless steel pipe enclosure, deck-mounted dual-temp push-button conical faucet.

Available without overflow hole.

Cautions:

- Provide tamper-resistant sealant at joint between underside of lavatory and top edge of pipe enclosure.
- A difficult but possible ligature opportunity may exist with this product. A series of shoelaces tied together may be looped over the lavatory and pulled back toward the support wall under the pipe enclosure.



Division 22 | Plumbing

Lavatory Basins

General Notes

Solid surface integral, countertop mounted and undermount lavatories are all acceptable when part of an assembly that is itself designed to be non-loopable.

Code Notes

Provide ADA compliant handicapped accessible lavatory assembly configurations where required.



American Standard

www.americanstandard-us.com

Rondalyn Countertop Sink

High gloss stain resistant vitreous china sink. Specify without overflow.



American Standard

www.americanstandard-us.com

Mezzo Semi-Countertop Sink

Self rimming fine fire clay semi-countertop sink. Specify without overflow.



Division 22 | Plumbing

Lavatory Pipe Enclosures



General Notes

Custom fabrications can be viable alternatives and, when properly detailed, may be preferable to pre-manufactured enclosures.



Installation Notes

Specify tamper-resistant fasteners.



IPS Corporation

www.ipscorp.com

Truebro Lav Shield Model #2018

Cautions:

- Pipe enclosure will conceal exposed plumbing piping, but is used with wall-mounted lavatory that poses looping opportunity.
- Careful scribing to underside of lavatory is required for a proper fit and sealant joint.
- Coordinate model of enclosure with model of wall-mounted lavatory.



Division 22 | Plumbing

Lavatory Faucets

General Notes

Faucets must be considered as part of the entire assembly.

Installation Notes

Specify projecting spouts only when the lavatory is positioned so that the lateral ligature hang is not possible (i.e. recessed in a niche).



Behavioral Safety Products

www.besafeprod.com

SF400 Ligature-Resistant Sensor Faucet

Deck mounted faucet is a single temperature faucet without controls. It may be specified as hard-wired or with battery power.



Chicago Faucets

www.chicagofaucets.com

ELR Touch Free Ligature-Resistant Faucet 4" Center, 8" Center with Escutcheon

Deck mounted faucet is a single temperature faucet without controls.



Behavioral Safety Products

www.besafeprod.com

SF380 Ligature-Resistant Metering Faucet

Deck mounted faucet is a dual temperature faucet with push button controls.



T&S Brass and Bronze Works, Inc.

www.tsbrass.com

EC-3113-VF05 Sensor Activate Faucet

Deck mounted faucet is a single temperature faucet without controls.



Division 22 | Plumbing

Lavatory Faucets

General Notes

Faucets must be considered as part of the entire assembly.

Installation Notes

Specify projecting spouts only when the lavatory is positioned so that the lateral ligature hang is not possible (i.e. recessed in a niche).



Whitehall Manufacturing

www.whitehallmfg.com

WH3375-SO Best Care Ligature-Resistant Sensor Activated Faucet

Deck mounted faucet is a single temperature faucet without controls. Designed to retrofit onto existing 4" center-set lavatory decks.



Whitehall Manufacturing

www.whitehallmfg.com

Best Care Conical Ligature Resistant Faucets

Deck mounted conical faucet. Specify one of the following, with appropriate control valve assembly.

- WH3376 - Single temperature with pneumatic pushbutton
- WH3377 - Dual temperature with pneumatic pushbutton
- WH3376-PPZ - Single temp with Piezo touch button
- WH3377-PPZ - Dual temp with Piezo touch buttons.



Division 22 | Plumbing

Lavatory Faucets

General Notes

Faucets must be considered as part of the entire assembly.



Installation Notes

Specify projecting spouts only when the lavatory is positioned so that the lateral ligature hang is not possible (i.e. recessed in a niche).

Kohler Co.

www.kohler.com

K-922 Laminar Faucet

Note: This product's recess presents opportunity for wedge ligature.



Division 22 | Plumbing

Lavatory Grid Strainers

Installation Notes

Coordinate plumbing fitting and piping length associated with drains to ensure fit in pipe enclosures.



Oddball Industries

www.oddballindustries.com

SP-11-GDK Grid Drain Kit

Effective drainage is achieved only with the included air vent. Air introduction valve may not meet all local codes.

Caution: Although drainage holes are half the diameter as typical grid strainers, making threading of a thin ligature difficult, a paper clip can be woven through the perforations creating a tie off opportunity.



Typical Grid Strainer & Drain

Note: Typical grid strainers are rejected because ligature can be created by threading a ligature item through the perforations and be hung over the lavatory or vanity edge.



Division 22 | Plumbing

Toilets, General

General Notes

Toilets located in inpatient areas shall be specified as either 3.5 gallons per flush (gpf) blowout or 1.6 gpf siphon jet. They are equally effective in forcing matter through the trap and clearing the bowl.

Blowout Toilets

Blowout toilets are designed to clear the bowl with a high volume of water discharged from the bowl rim. Although these toilets are louder than siphon jet toilets, it has been noted that the higher volume of water allows matter to be forced further down the waste piping system. Please note that 3.5 gpf blowout toilets may not be permissible by code in all jurisdictions, and should be evaluated before selecting this option.

- Provides high velocity and jet action
- Noisy

Siphon Jet Toilets

Siphon jet toilets are designed with an incorporated water jet in the trapway that forces matter through the trap by creating suction in the bowl to pull the contents through as well. Siphon jets are manufactured with 1.1, 1.28 and 1.6 gpf and must be paired with the appropriate flush valve. Currently the 1.6 gpf models are recommended due to evaluation and OMH acceptance of performance.

- Economical water usage
- More commonly used due to quiet actions

Division 22 | Plumbing Toilets

General Notes

Due to the possibility of inappropriate behavior, 3.5 gpf blowout toilets and 1.6 gpf siphon jet toilets are recommended.



Installation Notes

The wall surface must be flush with the toilet to avoid gaps that can become ligature points.



Specify standard toilets with heavy duty carriers. Specify bariatric toilets with bariatric carriers. Coordinate with manufacturers for specific carrier model specifications.

Code Notes

3.5 gpf blowout toilets may not be permissible by code in all jurisdictions, and should be evaluated before selecting this option.



Caution Notes

- Floor mounted toilets must be provided with complete closure between the toilet and wall to reduce ligature opportunities.
- Toilet seats that are not integral with the bowl create ligature opportunities.

American Standard

www.americanstandard-us.com

Huron Toilet



Behavioral Safety Products

www.besafeprod.com

Ligature-Resistant Toilet #TN691

Floor mounted, back spud, 1.6 gpf siphon jet with integral seat or prepped for conventional toilet seat.



Kohler Co.

www.kohler.com

Anglesey K-4396 Toilet

Floor mounted, back spud, 1.6 gpf siphon jet with detachable seat.



Division 22 | Plumbing Toilets

General Notes

Due to the possibility of inappropriate behavior, 3.5 gpf blowout toilets and 1.6 gpf siphon jet toilets are recommended.

Installation Notes

The wall surface must be flush with the toilet to avoid gaps that can become ligature points.

Specify standard toilets with heavy duty carriers. Specify bariatric toilets with bariatric carriers. Coordinate with manufacturers for specific carrier model specifications.

Code Notes

3.5 gpf blowout toilets may not be permissible by code in all jurisdictions, and should be evaluated before selecting this option.

Caution Notes

- Floor mounted toilets must be provided with complete closure between the toilet and wall to reduce ligature opportunities.
- Toilet seats that are not integral with the bowl create ligature opportunities.

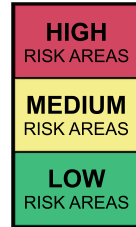

Intersan

www.aquadesignmfg.com

CWC150-AST Toilet CWC156-AST Toilet

Solid surface back-to-wall toilet with non-moving integral seat. 3.5 gpf valve available.



Whitehall Manufacturing

whitehallmfg.com

WH2142 Toilet

Floor mounted, powder coated stainless steel toilet with ligature-resistant ABS toilet seat. 3.5 gpf valve available.

Note: Interior of toilet should be powder coated white for use at NYS-OMH Facilities.



Division 22 | Plumbing Toilets



General Notes

Due to the possibility of inappropriate behavior, 3.5 gpf blowout toilets and 1.6 gpf siphon jet toilets are recommended.



Installation Notes

The wall surface must be flush with the toilet to avoid gaps that can become ligature points.

Specify standard toilets with heavy duty carriers. Specify bariatric toilets with bariatric carriers. Coordinate with manufacturers for specific carrier model specifications.

Code Notes

3.5 gpf blowout toilets may not be permissible by code in all jurisdictions, and should be evaluated before selecting this option.

Caution Notes

- Floor mounted toilets must be provided with complete closure between the toilet and wall to reduce ligature opportunities.
- Toilet seats that are not integral with the bowl create ligature opportunities.

Zurn

www.zurn.com

Z5647-BWL Toilet

Floor mounted, back spud, 1.6 gpf siphon jet with hinged seat.

Note: Toilet fails and breaks under heavy use.



Division 22 | Plumbing

Toilet Flushometers



General Notes

Concealed flush valves with remote infrared sensor controls reduce looping ligature opportunities.

Stainless Steel cover plate shall be surface-mounted to a steel angle assembly with securement to wall framing. Tamper-resistant sealant shall be applied to the perimeter of the plate to reduce looping opportunities.

Flushometer sensor shall be secured to the back side of the stainless steel plate with tamper resistant fasteners, with the plate cut to allow infrared sensor and/or push button operation.

Coordinate size of plate and angle assembly with water closet and grab bars selected to ensure adequate clearance for removal of plate.

Verify flush valve requirements of remote flushometer sensor to ensure it can be mounted to the rear of the stainless steel cover plate to reduce ligature opportunities.



NYS-OMH Standard Concealed Flush Valve Assembly

Concealed Flush Valve Assembly with Push Button Actuator

Illustration shows a floor mounted toilet with a Sloan Flush Valve. Similar detail with infrared sensor.

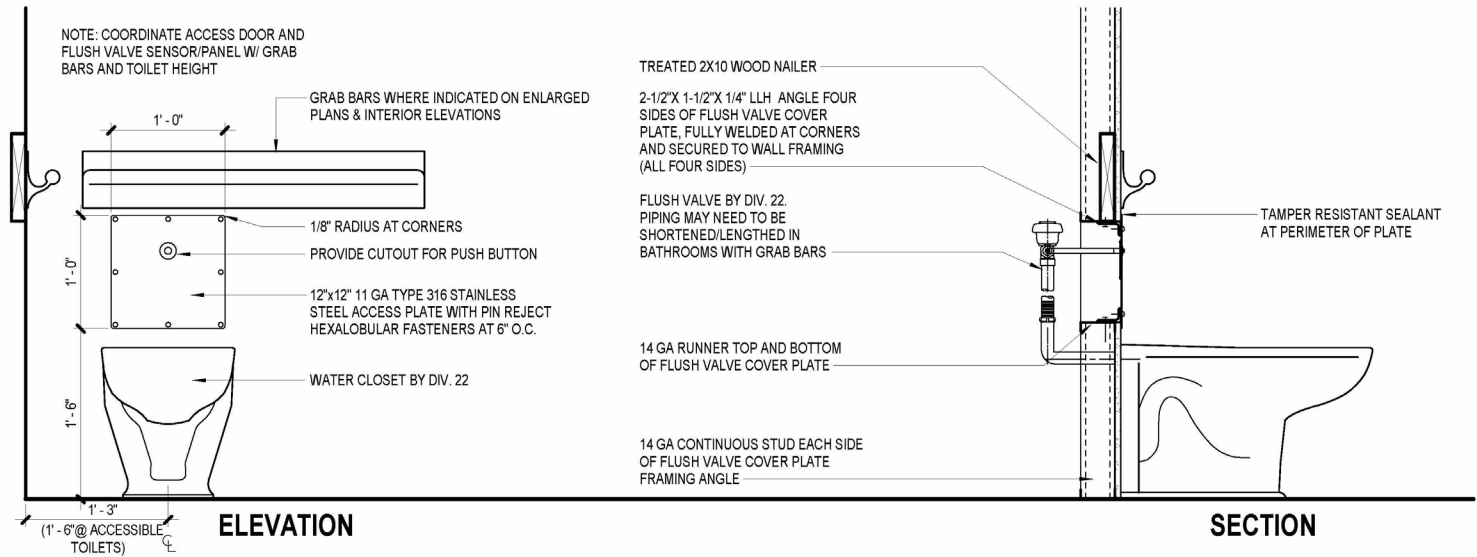

3 TYPICAL FLUSH VALVE DETAIL
SCALE: 1" = 1'-0"

Division 22 | Plumbing

Toilet Flushometers

General Notes

Concealed flush valves with remote infrared sensor controls reduce looping ligature opportunities.



Installation Notes

This product category in particular warrants considerable coordination.



Manufacturer supplied infrared cover plates may be designed for surface mounting and may require customization to provide a flush installation.

Acceptable flush valve manufacturers indicate an ability to assemble offset installations to avoid conflicts with grab bars. Verify with each manufacturer the specific requirements for offset plumbing extensions, access panel size and positioning, and remote infrared sensor connections and cover plate dimensions.



Zurn

www.zurn.com

ZER6152AV Flush Valve

AquaSense AV concealed sensor operated, battery powered flush valve.



Sloan Valve Company

www.sloanvalve.com

Regal Model 150ES Flushometer

Concealed push button (manual) activated, flushometer.



Sloan Valve Company

www.sloanvalve.com

Royal Optima 143 ESS Flushometer

Concealed offset flushometer with wall-mounted sensor.



Sloan Valve Company

www.sloanvalve.com

Royal Optima 152 ESS Flushometer

Concealed flushometer with wall-mounted sensor.



Division 22 | Plumbing

Toilet Flushometers



General Notes

Concealed flush valves with remote infrared sensor controls reduce looping ligature opportunities.



Installation Notes

This product category in particular warrants considerable coordination.

Manufacturer supplied infrared cover plates may be designed for surface mounting and may require customization to provide a flush installation.

Acceptable flush valve manufacturers indicate an ability to assemble offset installations to avoid conflicts with grab bars. Verify with each manufacturer the specific requirements for offset plumbing extensions, access panel size and positioning, and remote infrared sensor connections and cover plate dimensions.

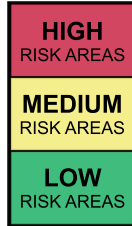

Sloan Valve Company

www.sloanvalve.com

Royal Optima Sensor Activated Flushometer 611 ES WB

Concealed sensor operated, back spud, wall-mounted flushometer with accessible wall box.



Division 22 | Plumbing

Toilet Flushometer Covers

General Notes

Flush valve covers are only recommended for retrofitting existing fixtures.

Caution Notes

Confirm that the flush valve covers fit the existing flush valve assemblies well enough to allow for free operation of the equipment, without providing a potential ligature point through the opening for the flushing mechanism.



Behavioral Safety Products

www.besafeprod.com

Ligature-Resistant Flush Valve Cover #FV600

One piece unit, can be field cut to fit varying flush valve dimensions. White, high impact, abuse-resistant, heavy gauge material.

Note:
Specify handing and flush activator type.



Whitehall Manufacturing

www.whitehallmfg.com

WH2802 Sloped Top Ligature Resistant Flush Valve Cover

16 gauge type 304 stainless steel with powder coated finish. Provide powder coated tamper-resistant fasteners.



Division 22 | Plumbing

Toilet Flush Valve Covers



General Notes

Flush valve covers are only recommended for retrofitting existing fixtures.



Caution Notes

Confirm that the flush valve covers fit the existing flush valve assemblies well enough to allow for free operation of the equipment, without providing a potential ligature point through the opening for the flushing mechanism.

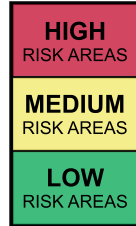

Norva Plastics

www.norvaplastics.com

ABS High-Impact Toilet Plumbing Cover

High-impact solid surface, customized to specifications.

Caution: Careful scribing to fixture is required for a proper fit and sealant joint



Division 22 | Plumbing Hydration Stations

General Notes

A remote cooler is required for chilled water dispensing and a drainage system is required for waste water.

Coordinate appropriate wall depth and location for remote chiller.

The top of the hydration station access door must be sloped.

Installation Notes

Drain grilles must be securely fastened with tamper-resistant fasteners. Integral cup dispensers must be securely fastened to the filling station housing.



Filtrine Manufacturing Company
www.filtrine.com

B103-HR
 Stainless steel, constructed with a one-piece cover plate. The exterior is made without seams, exposed edges, or screws. Able to fit in a standard 4" wall.

Caution: Perforated drainage holes allow for wedging opportunities.



Whitehall Manufacturing
www.whitehallmfg.com

WHBF3 Pushbutton Ligature-Resistant Cup Filler | WHBF4 Sensor Activated Ligature-Resistant Cup Filler

Semi- Recessed, stainless steel, white powder coated finish with a key latch and hinged access door with a sloped top.



Division 22 | Plumbing

Hydration Stations



General Notes

A remote cooler is required for chilled water dispensing and a drainage system is required for waste water.

Coordinate appropriate wall depth and location for remote chiller.

The top of the hydration station access door must be sloped.

Installation Notes

Drain grilles must be securely fastened with tamper-resistant fasteners. Integral cup dispensers must be securely fastened to the filling station housing.

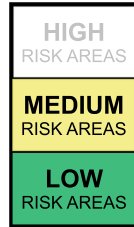

Willoughby Industries, Inc.

www.willoughby-ind.com

WBDF-1519-HC Drinking Fountain with Shroud

Notes:

- Provide tamper-resistant sealant at joint between underside of lavatory and top edge of shroud where needed.

Cautions:

- Bubbler and Perforated drainage holes allow for wedging opportunities.
- A difficult but possible ligature opportunity may exist with this product. A series of shoelaces tied together may be looped over the drinking fountain and pulled back toward the support wall under the shroud.

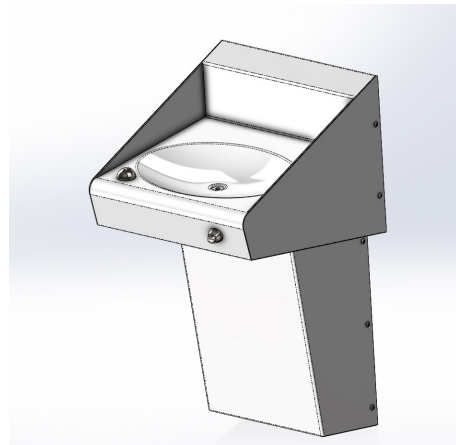

Division 22 | Plumbing

Hydration Stations



General Notes

A remote cooler is required for chilled water dispensing and a drainage system is required for waste water.



The top of the hydration station access door must be sloped.

Installation Notes

Drain grilles must be securely fastened with tamper-resistant fasteners. Integral cup dispensers must be securely fastened to the filling station housing.

Filtrine Manufacturing Company

www.filtrine.com

B103-C2-HR

16 gauge type 304 stainless steel with a satin finish. Hinged access door with a sloped top and keyed lock. Fits in 4" cavity wall.

Note: Sharp corners and raw metal edges present opportunity for self-harm.



Division 22 | Plumbing

Shower Heads



Behavioral Safety Products

www.besafeprod.com

SH340 Ligature-Resistant Shower Head

Polished chrome-plated, wall mounted shower head with pivoting head, directing the water stream up or down to allow full coverage for patients of different heights. No side to side movement.



Galvin Engineering

www.galvinengineering.com

40691 Shower Rose 65

Chrome plated Safe-Cell vandal resistant shower head.



Chicago Faucets

www.chicagofaucets.com

621-CP Institutional Shower Head

Oddball Industries

www.oddballindustries.com

SP-7 Shower Head



Intersan

www.aquadesignmfg.com/

SNC01 Ceiling Mounted Shower Head



Division 22 | Plumbing

Shower Heads



Moen
<http://pro.moen.com>

M-Dura 8292



Speakman Company
www.speakmancompany.com

S-2460 Shower Head



Behavioral Safety Products
www.besafeprod.com

SH330 Shower Head



Oddball Industries
www.oddballindustries.com

SP-7TF Tub Filler



Willoughby Industries, Inc.
www.willoughby-ind.com

CSH Ligature-Resistant Head Assembly



Division 22 | Plumbing

Shower Heads



Whitehall Manufacturing

www.whitehall-mfg.com

CSH Conical Ligature-Resistant Shower Head

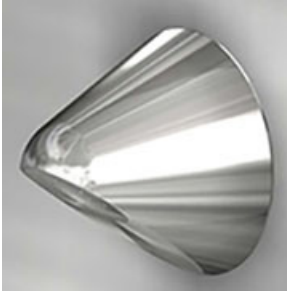

Whitehall Manufacturing

www.whitehall-mfg.com

WHD-SHD-W Conical Ligature-Resistant Wall Mounted Shower Head



Whitehall Manufacturing

www.whitehall-mfg.com

WHSHD-C Conical Ligature-Resistant Ceiling Mounted Shower Head



Division 22 | Plumbing

Shower Heads



Symmons Industries, Inc.

www.symmons.com

4-150 Shower Head (Institutional Type)

Note: Plastic Nozzle is easily removable and product does not fasten tightly to the wall, allowing ligature.



Powers

www.powerscontrols.com

141 381 Institutional Shower Head

Note: Tie off ligature opportunity at end of shower head.

Delta

www.deltafaucet.com

060793A Vandal Resistant Wall Mounting Shower Head

Note: Tie off ligature opportunity at end of shower head.



Division 22 | Plumbing

Hand Showers

General Notes

Hand showers must be installed in addition to a primary ligature-resistant shower head at all ADA accessible showers.



Code Notes

Only provide hand showers where required by code. Review and understand ANSI A117.1-2003, Section 608.6 exception, which allows a second fixed shower head in lieu of hand shower in specific situations.

Installation Notes

When a fixed shower head and hand shower are both used, provide either a ligature-resistant diverter valve or separate ligature-resistant control system for each fixture.

Intersan

www.aquadesignmfg.com

40707 Quick Release Handheld Shower

Hand held shower with ligature-resistant quick connect wall connection.



Oddball Industries

www.oddballindustries.com

SP-7WC Quick Connect Hand Shower

Hand held shower with quick disconnect adapter.

Caution:

Tie-off ligature opportunity exists at hose bib. Install hand shower at the low end of the permitted reach range to minimize potential ligature risk from fixture.



Division 22 | Plumbing

Hand Showers

General Notes

Hand showers must be installed in addition to a primary ligature-resistant shower head at all ADA accessible showers.



Code Notes

Only provide hand showers where required by code. Review and understand ANSI A117.1-2003, Section 608.6 exception, which allows a second fixed shower head in lieu of hand shower in specific situations.

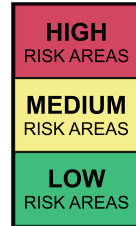

Installation Notes

When a fixed shower head and hand shower are both used, provide either a ligature-resistant diverter valve or separate ligature-resistant control system for each fixture.

Whitehall Manufacturing

www.whitehall-mfg.com

WHCHS Handheld Shower

Handheld shower with a ligature resistant adapter base.



Division 22 | Plumbing

Shower Controls & Activators

General Notes

Best practice recommends controlled (limited) flow time. Various mechanisms and controllers can provide this option; some are factory set and some can be adjusted by staff. Review and select products accordingly.



Armstrong International, Inc.

www.armstronginternational.com

Sense DMV2 Water Temp Control
Stainless steel face plate is to be specified for all NYS-OMH facilities. Provide tamper-resistant sealant at perimeter of plate.



Chicago Faucets

www.chicagofaucets.com

1920-VOCLRCP Ligature-Resistant Shower Valve, Handle & Escutcheon Plate



Best practice recommends temperature control by resident. Several of the acceptable mechanisms don't provide this option. Review and select products accordingly.



Cautions:

- Control buttons are plastic and have the potential to be damaged.
- Product can be specified with a plastic cover by facilities other than NYS-OMH, but should be used with caution due to the increased potential to be damage.

Installation Notes

When both shower heads and hand showers are provided, specify either a diverter valve or separate shower controls for both.



Behavioral Safety Products

www.besafeprod.com

SV230 Ligature-Resistant Shower Valve, Handle & Escutcheon Plate



Intersan

www.aquadesignmfg.com

50140 Ligature-Resistant Shower Diverter



Division 22 | Plumbing

Shower Controls & Activators

General Notes

Best practice recommends controlled (limited) flow time. Various mechanisms and controllers can provide this option; some are factory set and some can be adjusted by staff. Review and select products accordingly.

Best practice recommends temperature control by resident. Several of the acceptable mechanisms don't provide this option. Review and select products accordingly.

Installation Notes

When both shower heads and hand showers are provided, specify either a diverter valve or separate shower controls for both.



Leonard Valve Company

www.leonardvalve.com

4500 LR Series Aquatrol

Pressure actuated mixing valve.

Caution: This product does not meet ADA requirements for graspability.



Niekamp Tool Company

www.niekampinc.com

SSK-1022E Suicide Prevention Shower Handle



Powers

www.powerscontrols.com

447 Infrared

HydroGuard ESP infrared sensor shower control.



Powers

www.powerscontrols.com

447 Piezo

HydroGuard ESP pushbutton sensor shower control.



Division 22 | Plumbing

Shower Controls & Activators

General Notes

Best practice recommends controlled (limited) flow time. Various mechanisms and controllers can provide this option; some are factory set and some can be adjusted by staff. Review and select products accordingly.

Best practice recommends temperature control by resident. Several of the acceptable mechanisms don't provide this option. Review and select products accordingly.

Installation Notes

When both shower heads and hand showers are provided, specify either a diverter valve or separate shower controls for both.



Oddball Industries

www.oddballindustries.com

SP-10 Shower Mixing Valve

The SP-10 Mixing Valve is available with two different styles of ligature-resistant handles, designated A and B (shown).

Caution:

- A tamper-resistant fastener is not included and may be available for this product. A conventional fastener may be installed and filled with tamper-resistant sealant if tamper-resistant fastener is unavailable.



Oddball Industries

www.oddballindustries.com

SP-12 Diverter Valve

The SP-12 Diverter Valve is available with two different styles of ligature-resistant handles, designated A (shown) and B.

Cautions:

- This product (handle Style A) does not meet ADA requirements for graspability. May be difficult to operate when wet.
- A tamper-resistant fastener is not included and may be available for this product. A conventional fastener may be installed and filled with tamper-resistant sealant if tamper-resistant fastener is unavailable.



Division 22 | Plumbing

Shower Controls & Activators

General Notes

Best practice recommends controlled (limited) flow time. Various mechanisms and controllers can provide this option; some are factory set and some can be adjusted by staff. Review and select products accordingly.

Best practice recommends temperature control by resident. Several of the acceptable mechanisms don't provide this option. Review and select products accordingly.

Installation Notes

When both shower heads and hand showers are provided, specify either a diverter valve or separate shower controls for both.



Symmons Industries, Inc.

www.symmons.com

4-420SP Series Showeroff Metering Showering System

Piston-actuated metering shower valve with tapered pushbutton control..

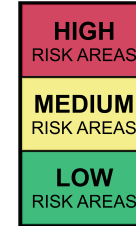

Whitehall Manufacturing

www.whitehall-mfg.com

PBH Hemispherical Pushbutton

Specify with appropriate control valve assembly, one or two button options. Two buttons allows three preset temperatures (cold, warm & lukewarm).



Whitehall Manufacturing

www.whitehall-mfg.com

SV16 Tri-Lever Mixing Valve

Tri-lever handle, temperature/pressure balancing mixing valve.



Whitehall Manufacturing

www.whitehall-mfg.com

Ligature-Resistant Shower Diverter

Tri-lever handle diverter.



Division 22 | Plumbing

Shower Controls & Activators

General Notes

Best practice recommends controlled (limited) flow time. Various mechanisms and controllers can provide this option; some are factory set and some can be adjusted by staff. Review and select products accordingly.

Best practice recommends temperature control by resident. Several of the acceptable mechanisms don't provide this option. Review and select products accordingly.

Installation Notes

When both shower heads and hand showers are provided, specify either a diverter valve or separate shower controls for both.



Willoughby
www.willoughby-ind.com

TPLR Ligature-Resistant Shower Mixing Valve



Willoughby
www.willoughby-ind.com

Electronic Piezo Switch



Willoughby
www.willoughby-ind.com

DVLR Ligature-Resistant Shower Diverter Valve



Division 22 | Plumbing

Shower Controls & Activators

General Notes

Best practice recommends controlled (limited) flow time. Various mechanisms and controllers can provide this option; some are factory set and some can be adjusted by staff. Review and select products accordingly.

Best practice recommends temperature control by resident. Several of the acceptable mechanisms don't provide this option. Review and select products accordingly.

Installation Notes

When both shower heads and hand showers are provided, specify either a diverter valve or separate shower controls for both.



Bradley Corporation

www.bradleycorp.com

HSC95 Ligature-Resistant Front-Mounted Panel Shower

Note: Looping ligature opportunity at the shower control knob.



Symmons Industries, Inc.

www.symmons.com

B-40904-1 Recessed Shower Activator

Note: Recessed shower activator is loopable and does not meet the ADA requirements for graspability.

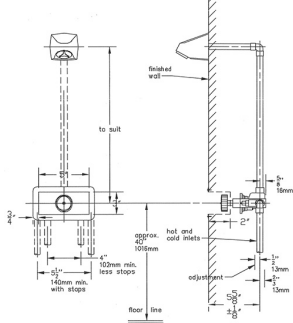

Symmons Industries, Inc.

www.symmons.com

420 Series Showeroff Metering Showering System

Note: Manufacturer does not recommend fixture for use in Behavioral Health settings.



Division 23 | HVAC

HVAC, General



General Notes

Generally, ceiling mounted diffusers and grilles are more resistant to tampering, while wall-mounted elements provide more structural support for heavy and deep correction-grade assemblies.

Diffusers & Grilles

The selection of diffusers and grilles must be carefully considered in light of all relevant patient risk criteria, mechanical performance requirements, and the installed substrate. Louver and grille opening size and spacing is a critical consideration for structural performance, air flow and ligature resistance. The most secure and ligature-resistant assemblies are typically very heavy, requiring careful consideration for structural support and the sequence of construction.

The selection of radiator covers must be carefully considered with respect to all relevant patient risk criteria, mechanical performance requirements, and the installed substrate. Perforated radiator covers pose a particular risk as they can be looped by a thin shoelace or similar object. Because these enclosures are typically surface-mounted, careful consideration must be given to the installation conditions at these covers to prevent wedging/looping opportunities at the installed substrate. Tamper-resistant sealant should be utilized to close all gaps at perimeter of enclosure.

Diffusers and grilles should be securely mounted in place using tamper-resistant fasteners. Diffusers and grilles, and all accessible elements of the housing should be attached to permanently affixed concealed back angles that are part of the assembly, or to wall or ceiling framing elements. Because of the inherent variations in the manufacturing process, specifiers should procure samples of diffusers prior to specifying. Variations in finish along with manufacturing tolerances have caused unsafe installations in some products where other instances of the same line have achieved safe installations.

It should be noted that all ligature-resistant diffusers and grilles reduce air flow. Evaluation of this reduction shall be performed prior to incorporation/replacement of these diffusers and grilles.

Escape

Where escape is a primary risk criterion, diffusers and grilles should be reduced in size to the greatest extent possible. If diffusers and grilles are required to be large enough to allow passage, they should be securely mounted in place using welded joints and/or tamper-resistant fasteners. Diffusers and grilles, and all accessible elements of the housing should be attached to wall or ceiling framing elements and to the ductwork. Face plate construction should be thick enough to resist impact assaults and should not be removable, except with special tamper-resistant fastener tools. Passage restrictors should be permanently welded in the sleeve housing within the assemblies.

Ligature Resistance

Where ligature resistance is a primary risk criterion, diffusers and grilles should be specifically designed with closely spaced welded deep "S" and "Z" shaped vanes that prevent looping, or they should be protected by heavy gauge metal face plates with small, tightly spaced, perforated holes. Perforated grilles with 11 ga. (1/8" thick) face plates with holes no larger than 1/8" in diameter on 3/16" staggered centers have been tested and tend to resist looping, however all perforated grilles should be reviewed prior to specification/installation as manufacturing tolerances and fabrication errors may result in conditions that allow looping.

Perforated diffusers, grilles and radiator covers utilizing the industry standard of 3/16" hole on 9/32" spacing pose a particular risk as they can be easily looped by a thin shoelace or similar object. Because these devices are prevalent in existing inpatient environments, they are identified in this document as ACCEPTED in medium risk environments and noted with specific USE WITH CAUTION language. It should be noted that smaller holes and tighter spacing of holes, and heavier gauge metal plate are also available from several manufacturers as standard options. OMH will continue to perform additional testing on perforated grilles and diffusers and is researching alternative solutions. The risk of utilizing these devices shall be noted and evaluated by each facility.

Concealing Contraband

Where concealing contraband is a primary risk criterion, diffusers and grilles should be reduced in size to the greatest extent possible and securely mounted in place using tamper-resistant fasteners. Diffusers and grilles, and all accessible elements of the housing should be attached to wall or ceiling framing elements. Face plate construction should be thick enough to resist impact assaults and should not be removable, except with special tamper-resistant fastener tools.

Additional Information

CO2 sensors are not currently available in any ligature-resistant form and should only be used where accessible to patients in low or medium risk areas. CO2 sensors may be installed within ducts in high risk areas, but this will not qualify for the USGBC's LEED credits for high occupancy mechanically ventilated spaces.

Division 23 | HVAC

Thermostats

General Notes
Use covers and/or flat plate digital thermostats in high risk areas.



Automated Logic Corporation
www.automatedlogic.com

Sensor Thermistor, Plate ALC/10K-2-SP with Logo



Kele
www.kele.com

KTP Series Stainless Steel Flush-Mount Thermistor and RTD Sensors



Division 23 | HVAC

Diffusers & Grilles



General Notes

The products listed in this section have been tested for patient safety on the patient accessible side only. Any concealed features of the products are incidental, and should not be assumed as "Accepted."

Perforated grilles and radiator covers utilizing the industry standard of 3/16" holes on 9/32" spacing are easily looped and may pose a ligature risk. Perforation patterns of 1/8" at 3/16" centers have been shown to resist looping but do not entirely eliminate this risk. The specifier must carefully review these products to determine whether the inherent risk of perforated products is appropriate for use prior to specification.

Installation Notes

Careful detailing of diffusers and grilles with substrate is required.

Some of the diffusers included in this document have several options for mounting, installation, and overall configuration. Several of the mounting options may limit access resulting in inaccessible ductwork for cleaning and maintenance. The specifier must carefully review these conditions with owner's representative and maintenance personnel prior to specification and installation.

Performance Criteria

The configuration of ligature-resistant grilles may offer significantly less free area than similarly-sized standard commercial grilles. Engineers shall size grilles appropriately to achieve the required free area.

Finish

The metal finish of perforated and bladed diffusers affects their ligature-resistance. Specify a powder-coated paint finish.



Anemostat

www.anemostat.com

SSV22 Maximum Security Extra Heavy Duty Grille

With 3/16" x 3/16" Openings. White powder coat finish.

Caution: Bladed diffusers pose a specific risk with the wedging of knotted cords, shoelaces, etc. Specifier must use caution when specifying these items



Anemostat

www.anemostat.com

SSV26 Maximum Security Extra Heavy Duty Griller

With 2" (nom.) x 3/16" Openings. White powder coat finish.

Caution: Bladed diffusers pose a specific risk with the wedging of knotted cords, shoelaces, etc. Specifier must use caution when specifying these items



Anemostat

www.anemostat.com

SSV23 Maximum Security Extra Heavy Duty Grille

With 7/16" x 3/16" Openings. White powder coat finish.

Caution: Bladed diffusers pose a specific risk with the wedging of knotted cords, shoelaces, etc. Specifier must use caution when specifying these items



Anemostat

www.anemostat.com

SV432 Maximum Security Extra Heavy Duty Grille

With 2" (nom.) x 3/16" Openings. White powder coat finish.

Caution: Bladed diffusers pose a specific risk with the wedging of knotted cords, shoelaces, etc. Specifier must use caution when specifying these items



Division 23 | HVAC

Diffusers & Grilles

General Notes

The products listed in this section have been tested for patient safety on the patient accessible side only. Any concealed features of the products are incidental, and should not be assumed as "Accepted."



Perforated grilles and radiator covers utilizing the industry standard of 3/16" holes on 9/32" spacing are easily looped and may pose a ligature risk. Perforation patterns of 1/8" at 3/16" centers have been shown to resist looping but do not entirely eliminate this risk. The specifier must carefully review these products to determine whether the inherent risk of perforated products is appropriate for use prior to specification.



Installation Notes

Careful detailing of diffusers and grilles with substrate is required.



Some of the diffusers included in this document have several options for mounting, installation, and overall configuration. Several of the mounting options may limit access resulting in inaccessible ductwork for cleaning and maintenance. The specifier must carefully review these conditions with owner's representative and maintenance personnel prior to specification and installation.

Performance Criteria

The configuration of ligature-resistant grilles may offer significantly less free area than similarly-sized standard commercial grilles. Engineers shall size grilles appropriately to achieve the required free area.

Finish

The metal finish of perforated and bladed grilles affects their ligature-resistance. Specify a powder-coated paint finish.

Kees, Inc.

www.kees.com

SEG-13B Maximum Security Risk Resistant "V" Passageway Grille with Supports

With 12 gauge steel "V" Louvers with 3/16" openings and supports with 3/16" openings. 1" flange stitch welded. Sleeve continuously welded. Standard white finish.

Caution: Bladed diffusers pose a specific risk with the wedging of knotted cords, shoelaces, etc. Specifier must use caution when specifying these items

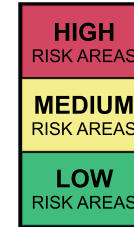
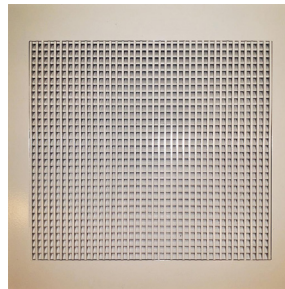

Price

www.priceindustries.com

MSRRCD Maximum Security Risk Resistant Ceiling Diffuser

With 35 degree deflection blades at 5/16" blade spacing. B12 Standard White Finish.

Caution: Bladed diffusers pose a specific risk with the wedging of knotted cords, shoelaces, etc. Specifier must use caution when specifying these items



Division 23 | HVAC

Diffusers & Grilles

General Notes

The products listed in this section have been tested for patient safety on the patient accessible side only. Any concealed features of the products are incidental, and should not be assumed as "Accepted."



Perforated grilles and radiator covers utilizing the industry standard of 3/16" holes on 9/32" spacing are easily looped and may pose a ligature risk. Perforation patterns of 1/8" at 3/16" centers have been shown to resist looping but do not entirely eliminate this risk. The specifier must carefully review these products to determine whether the inherent risk of perforated products is appropriate for use prior to specification.



Installation Notes

Careful detailing of diffusers and grilles with substrate is required.



Some of the diffusers included in this document have several options for mounting, installation, and overall configuration. Several of the mounting options may limit access resulting in inaccessible ductwork for cleaning and maintenance. The specifier must carefully review these conditions with owner's representative and maintenance personnel prior to specification and installation.

Performance Criteria

The configuration of ligature-resistant grilles may offer significantly less free area than similarly-sized standard commercial grilles. Engineers shall size grilles appropriately to achieve the required free area.

Finish

The metal finish of perforated and bladed grilles affects their ligature-resistance. Specify a powder-coated paint finish.

Behavioral Safety Products

www.besafeprod.com

EG450 Ligature Resistant Exhaust/Supply Grille

3/64" thick perforated face with 1/8" holes on staggered centers. White powder coat finish.

Cautions:

- Perforated diffusers, grilles and radiator covers pose a particular risk as they can be easily looped by a thin shoelace or similar object.
- Due to quality control inconsistencies, potential wedging ligature opportunity may exist at joint between perforated plate and frame.

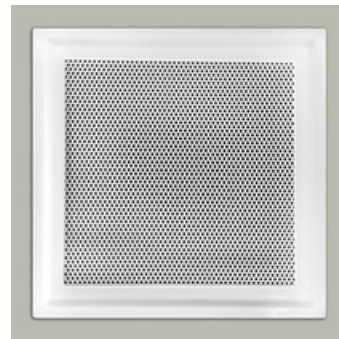

Price

www.priceindustries.com

MSPG with P5 Hole Pattern Perforated Face Security Grille

12 ga perforated face plate with 1/8" holes on 3/16" staggered centers. B12 Standard White Finish.

Caution: Perforated diffusers, grilles and radiator covers pose a particular risk as they can be easily looped by a thin shoelace or similar object.



Division 23 | HVAC

Diffusers & Grilles

General Notes

The products listed in this section have been tested for patient safety on the patient accessible side only. Any concealed features of the products are incidental, and should not be assumed as "Accepted."



Perforated grilles and radiator covers utilizing the industry standard of 3/16" holes on 9/32" spacing are easily looped and may pose a ligature risk. Perforation patterns of 1/8" at 3/16" centers have been shown to resist looping but do not entirely eliminate this risk. The specifier must carefully review these products to determine whether the inherent risk of perforated products is appropriate for use prior to specification.

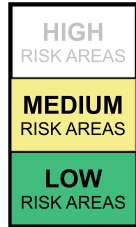

Installation Notes

Careful detailing of diffusers and grilles with substrate is required.



Some of the diffusers included in this document have several options for mounting, installation, and overall configuration. Several of the mounting options may limit access resulting in inaccessible ductwork for cleaning and maintenance. The specifier must carefully review these conditions with owner's representative and maintenance personnel prior to specification and installation.

Performance Criteria

The configuration of ligature-resistant grilles may offer significantly less free area than similarly-sized standard commercial grilles. Engineers shall size grilles appropriately to achieve the required free area.

Finish

The metal finish of perforated and bladed grilles affects their ligature-resistance. Specify a powder-coated paint finish.

Anemostat

www.anemostat.com

ASSG Maximum Security Extra Heavy Duty Grille Steel Perforated Face

With 3/16" diameter holes on 9/32" staggered centers. White powder coat finish.

Caution: Perforated diffusers, grilles and radiator covers pose a particular risk as they can be easily looped by a thin shoelace or similar object.

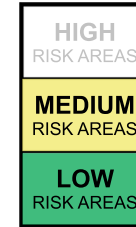
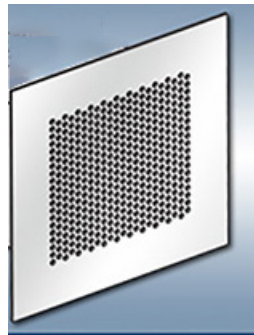

Carnes Company

www.carnes.com

RSPA51 Suicide Deterrent Security R&G

With 3/16" perforated face with 3/16" diameter holes on 9/32" staggered centers. White electrocoat acrylic baked enamel finish.

Caution: Perforated diffusers, grilles and radiator covers pose a particular risk as they can be easily looped by a thin shoelace or similar object.



Division 23 | HVAC

Diffusers & Grilles

General Notes

The products listed in this section have been tested for patient safety on the patient accessible side only. Any concealed features of the products are incidental, and should not be assumed as "Accepted."



Perforated grilles and radiator covers utilizing the industry standard of 3/16" holes on 9/32" spacing are easily looped and may pose a ligature risk. Perforation patterns of 1/8" at 3/16" centers have been shown to resist looping but do not entirely eliminate this risk. The specifier must carefully review these products to determine whether the inherent risk of perforated products is appropriate for use prior to specification.



Installation Notes

Careful detailing of diffusers and grilles with substrate is required.



Some of the diffusers included in this document have several options for mounting, installation, and overall configuration. Several of the mounting options may limit access resulting in inaccessible ductwork for cleaning and maintenance. The specifier must carefully review these conditions with owner's representative and maintenance personnel prior to specification and installation.

Performance Criteria

The configuration of ligature-resistant grilles may offer significantly less free area than similarly-sized standard commercial grilles. Engineers shall size grilles appropriately to achieve the required free area.

Finish

The metal finish of perforated and bladed grilles affects their ligature-resistance. Specify a powder-coated paint finish.

Kees, Inc.

www.kees.com

SEG-9SP3 Security Grille

14 ga steel perforated face with 3/16" diameter holes on 9/32" staggered centers. Two part polyurethane finish. White.

Caution: Perforated diffusers, grilles and radiator covers pose a particular risk as they can be easily looped by a thin shoelace or similar object.

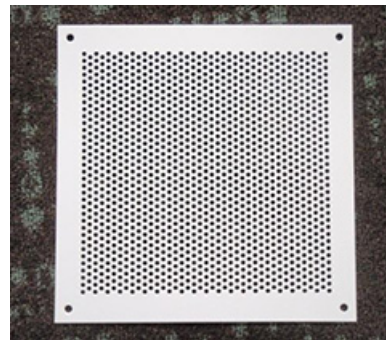

Kees, Inc.

www.kees.com

SEG-9LS3VH Security Diffuser

10 ga steel perforated face with 3/16" diameter holes on 9/32" staggered centers. Two part polyurethane finish. White.

Caution: Perforated diffusers, grilles and radiator covers pose a particular risk as they can be easily looped by a thin shoelace or similar object.

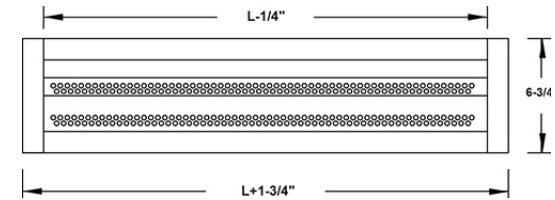

Division 23 | HVAC

Diffusers & Grilles

General Notes

The products listed in this section have been tested for patient safety on the patient accessible side only. Any concealed features of the products are incidental, and should not be assumed as "Accepted."



Perforated grilles and radiator covers utilizing the industry standard of 3/16" holes on 9/32" spacing are easily looped and may pose a ligature risk. Perforation patterns of 1/8" at 3/16" centers have been shown to resist looping but do not entirely eliminate this risk. The specifier must carefully review these products to determine whether the inherent risk of perforated products is appropriate for use prior to specification.



Installation Notes

Careful detailing of diffusers and grilles with substrate is required.



Some of the diffusers included in this document have several options for mounting, installation, and overall configuration. Several of the mounting options may limit access resulting in inaccessible ductwork for cleaning and maintenance. The specifier must carefully review these conditions with owner's representative and maintenance personnel prior to specification and installation.

Performance Criteria

The configuration of ligature-resistant grilles may offer significantly less free area than similarly-sized standard commercial grilles. Engineers shall size grilles appropriately to achieve the required free area.

Finish

The metal finish of perforated and bladed grilles affects their ligature-resistance. Specify a powder-coated paint finish.

Titus

www.titus-hvac.com

SG-SD Maximum Security Grille

3/16" perforated face with 3/16" diameter holes on 9/32" staggered centers. #26 White Finish.

Caution: Perforated diffusers, grilles and radiator covers pose a particular risk as they can be easily looped by a thin shoelace or similar object.

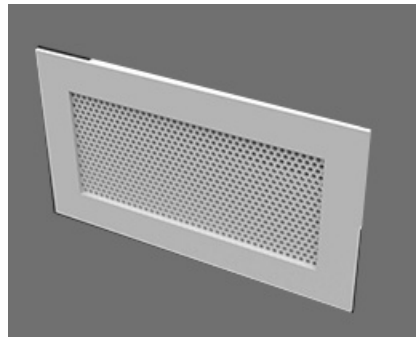

Carnes Company

www.carnes.com

RSPA41 Sleeved Security R&G Suicide Deterrent Supply Grille

12 ga hot rolled steel louvers installed at 3/8" centers. #11 Bright White finish.



Division 26 | Electrical

Receptacles & Cover Plates, General



General Notes

In new construction or substantial renovations, where arc fault and ground fault interruption are both provided at the receptacle, provide electrical cover plates that are either thermoplastic nylon or metal. In minor renovation projects, where providing arc fault and ground fault interruption are beyond the scope of the project, provide only metal electrical cover plates. In all cases, fasten cover plates to receptacle with tamper-resistant fasteners that are accepted in the NYS-OMH Patient Safety Standards. Two fasteners are recommended, though not required, for all cover plates.

Hospital Grade Receptacles

Hospital grade receptacles are on emergency circuits and receive back-up power from a generator.

Review applicable Codes and Guidelines to identify the areas Hospital Grade Receptacles are required.

Tamper-resistant Receptacles

Tamper-resistant receptacles feature built in safety shutters that block foreign objects from being inserted into the receptacle. Shutters remain closed if an object is inserted into one side of the receptacle. The shutters open only when a two bladed or grounded plug is inserted. Excessive tampering may compromise the receptacle.

Review applicable Codes and Guidelines to identify the areas tamper-resistance receptacles are required. Additional tamper-resistant receptacles may be provided as recommended by the facility's Risk Assessment.

AFCI (Arc Fault Circuit Interrupter) Protection

AFCI protection guards against damage or fires which can result from arcing and sparking that can arise from deteriorated wires, poor connections and breaches in wire insulation. Arc fault self-harm can be induced by holding two insulated conductors (e.g. paper clips while holding them in flexible plastic or rubber as an insulator) and bending them close enough together to get an electrical current to arc between them, perhaps in an effort to create a cigarette lighter or start a fire.

Review applicable Codes and Guidelines to identify the areas AFCI protection is required. Additional AFCI protection may be provided as recommended by the facility's Risk Assessment.

GFCI (Ground Fault Circuit Interrupter) Protection

GFCI protection guards against ground faults, and are an effective means of preventing electrical shocks. Ground fault self-harm can be induced by grounding oneself (e.g. to the floor) while holding one conductor (i.e., paper clips) in the hot side of the receptacle, causing the electrical current to flow through oneself to the ground.

Review applicable Codes and Guidelines to identify the areas GFCI protection is required. Additional GFCI protection may be provided as recommended by the facility's Risk Assessment.

Division 26 | Electrical

Receptacles & GFCI/AFCI Circuit Breakers

General Notes

See comments on previous general notes page.

Provide tamper-resistant receptacles with arc fault and ground fault interruption in all patient accessible areas of all psychiatric hospitals.

Provide dual protection circuit breakers for all circuits with devices in patient accessible areas when it is not feasible to provide dual protection at the receptacle location.

Circuit breakers are located within secure electrical panels outside of the patient environment. They are included in this document because they enhance the patient safety of the built environment.



Cooper Lighting Solutions

www.cooperlighting.com

TR8200 Series Hospital Grade Receptacles

Tamper-resistant.

Legrand

www.legrand.us

PTTR62HW Series Extra Heavy Duty Hospital Grade Receptacles

Tamper-resistant.

Leviton

www.leviton.com

8200-SG Series Tamper-resistant Receptacles



Cooper Lighting Solutions

www.cooperlighting.com

CHF Circuit Breaker

General Electric

www.ge.com

Dual Function Circuit Breaker

Schneider Electric

www.schneider-electric.com

QO Dual Function Circuit Breakers

Siemens

www.usa.siemens.com

Dual Function Circuit Breaker



Division 26 | Electrical Wall Plates

General Notes

Thermoplastic nylon wall plates are recommended. They are more flexible than thermoset (urea) products and have a shinier, glossy finish. Molded thermoplastic nylon wall plates also perform for maximum resistance to impact, abrasion, fading and discoloration. Nylon is resistant to stresses associated with high abuse applications.

Installation Notes

Nylon is pliable so it should be installed in a bed of tamper resistant sealant.



Legrand
www.legrand.us

Unbreakable Nylon Wall Plates

Leviton
www.leviton.com

Unbreakable Nylon Wall Plates



Hubbell
www.hubbell-wiring.com

Security Wall Plates (Metal)

Caution: Intended for use in OMH facilities only when other alternatives are considered unsuitable due to excessive tampering by patients.

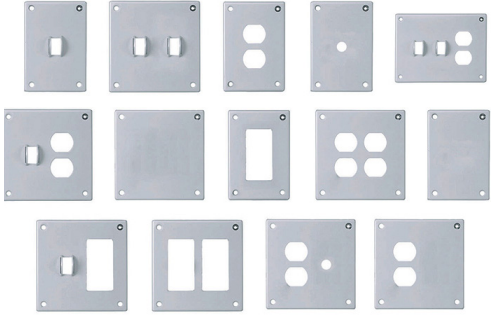

Division 26 | Electrical Wall Plates

General Notes

Thermoplastic nylon wall plates are recommended. They are more flexible than thermoset (urea) products and have a shinier, glossy finish. Molded thermoplastic nylon wall plates also perform for maximum resistance to impact, abrasion, fading and discoloration. Nylon is resistant to stresses associated with high abuse applications.

Polycarbonate is a thermoset plastic, so doesn't perform as well in this application.

Installation Notes

Nylon is pliable so it should be installed in a bed of tamper resistant sealant.



Cortech USA

www.cortechusa.com

Tiger Plates

Caution: Intended for use in OMH facilities only when other alternatives are considered unsuitable due to excessive tampering by patients.

Installation Note: Not suitable for gypsum wallboard installations. Plates fasten directly to the wall in lieu of typical recessed back box. Recommended for concrete or masonry walls only.

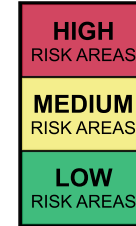

Kenall Manufacturing

www.kenall.com

Mighty Mac WSP/WPP Series Wall Plates

Caution: Intended for use in OMH facilities only when other alternatives are considered unsuitable due to excessive tampering by patients.

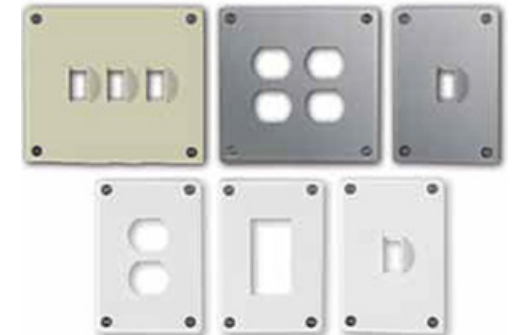

Division 26 | Electrical

Light Fixtures, General

Performance Criteria

Provide lighting that meets the following criteria:

- Lighting: High efficiency, high visual performance; dimmable where applicable.
- Lamps: LED per NYS-OMH standards.
- Diffuser|Lens: 1/8" thick minimum polycarbonate lens; clear or frosted preferred; securely retained within frame.
- Housing: Durable and abuse resistant.
- Exposed Fasteners: Tamper-resistant; finished to match housing.
- Maintenance: Standard replacement parts; minimum number of security fasteners.
- Approvals: Underwriters Laboratories (UL) and others as applicable. Reference NYS-OMH Lighting Standards Handbook for additional requirements.

Installation Notes

Install light fixtures flush with substrate. It is critical to ensure there are no gaps. Any remaining gaps shall be filled with tamper-resistant sealant.

Coordinate lighting fixture specifications with new/existing ceiling substrate prior to ordering. When installing light fixtures into a medium or high risk ceiling system, it is imperative that the installation of the light fixture does not diminish the patient safety of the ceiling system as a whole. Therefore, it is recommend to mechanically fasten light fixtures to the ceiling system in order to maintain the appropriate level of patient safety at the ceiling plane.

The following properties identified in the product descriptions of each fixture included in this section were present in the sample tested for patient safety:

- Size
- Required specification options
- Mounting configuration
- Inner lens thickness
- Outer lens thickness
- Housing
- Finish

Altering any of these properties may impact patient safety and therefore warrants additional testing of a sample fixture for patient safety evaluation.

Additional Notes

Verify photometrics of light fixtures with polycarbonate lenses during the project design.

The Office of Mental Health Lighting Standards Handbook is intended for use by Plant Superintendents and Design Consultants as a reference guide when replacing light fixtures. The Handbook details which energy saving options may be best for each application. It is important to also reference the Office of Mental Health Patient Safety Standard Guidelines when replacing or specifying light fixtures in patient areas. OMH reinforces the importance of patient safety before energy efficiency in their facilities in all patient areas.

Division 26 | Electrical

Light Fixtures, Interior, General, Surface-mounted

General Notes
See comments on previous general notes page.

Specification Notes
Coordinate lighting fixture specifications with new/existing ceiling substrate prior to ordering.

Only those models listed have been tested. Models with different options in any category warrant additional testing of a sample fixture.



Alva Lighting
www.alvalight.com

Priscilla

Size: 19"x8.5"
Required Options: BH (behavioral Health)
Mounting: drywall wall (vertical orientation only)
Outer Lens: 3.1mm vandal resistant architectural resin (by Alva)
Housing: 1.5mm stamped marine grade aluminum end caps
Finish: industrial grade powder coat

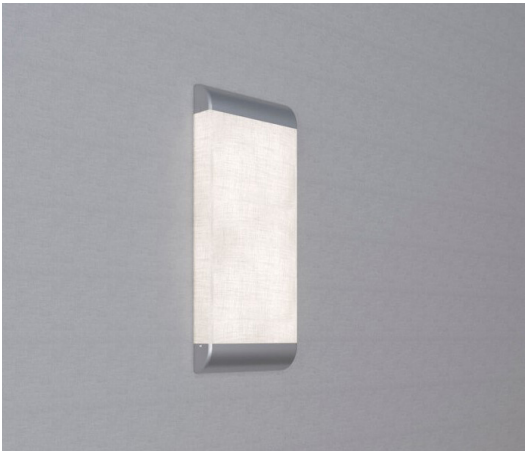

Cooper Lighting Solutions
www.cooperlighting.com

Fail-Safe FMB LD4 2ft LED

Size: 2'
Required Options: HS (high security for behavioral health)
Mounting: drywall
Inner Lens: 0.125" prismatic acrylic
Outer Lens: 0.25" clear polycarbonate
Housing: 16 gauge cold rolled steel
Finish: standard white



Division 26 | Electrical

Light Fixtures, Interior, General, Surface-mounted

General Notes

See comments on previous general notes page.

Specification Notes

Coordinate lighting fixture specifications with new/existing ceiling substrate prior to ordering.

Only those models listed have been tested. Models with different options in any category warrant additional testing of a sample fixture.



Kenall Manufacturing

www.kenall.com

Enviroseal ES5 Linear Wraparound

Size: 2'
Mounting: drywall ceiling & wall (horizontal orientation only)
Inner Lens: prismatic polycarbonate
Outer Lens: 0.125" pearlescent polycarbonate
Housing: seam welded 20 gauge stainless steel
Finish: white powder coat



Kenall Manufacturing

www.kenall.com

MedMaster Bullnose BHWB 3ft

Size: 3'
Required Options: -1 (torx head with center pin external fasteners)
Mounting: drywall
Outer Lens: 0.125" clear polycarbonate
Housing: 14 gauge cold rolled steel
Finish: standard white



Division 26 | Electrical

Light Fixtures, Interior, General, Surface-mounted

General Notes

See comments on previous general notes page.

Quality control of lighting fixtures is known to vary. Pay close attention to exposed edges of metal housing and flanges for sharpness.

Specification Notes

Coordinate lighting fixture specifications with new/existing ceiling substrate prior to ordering.

Only those models listed have been tested. Models with different options in any category warrant additional testing of a sample fixture.



Kenall Manufacturing

www.kenall.com

WCBU Mighty Mac

Size: 4'
 Mounting: drywall ceiling & wall (horizontal orientation only)
 Inner Lens: prismatic polycarbonate
 Outer Lens: clear polycarbonate
 Housing: 14 gauge cold rolled steel
 Finish: TGIC polyester powder coat



Kenall Manufacturing

www.kenall.com

**MedMaster Behavioral Health
 MMAC14, MMAC22, MMAC24**

Size: 1'x4', 2'x2', 2'x4'
 Mounting: drywall ceiling only
 Inner Lens: (standard) extruded high efficiency frosted DR acrylic
 Outer Lens: 0.187" clear polycarbonate
 Housing: 14 gauge cold rolled steel, spot welded
 Finish: TGIC polyester powder coat



Division 26 | Electrical

Light Fixtures, Interior, General, Surface-mounted

General Notes

See comments on previous general notes page.

Specification Notes

Coordinate lighting fixture specifications with new/existing ceiling substrate prior to ordering.

Only those models listed have been tested. Models with different options in any category warrant additional testing of a sample fixture.



Kenall Manufacturing

www.kenall.com

MightyMac SSA

Size: 1'x2'
 Required Options: must specify inner and outer lens
 Mounting: drywall ceiling & wall
 Inner Lens: prismatic polycarbonate
 Outer Lens: clear polycarbonate
 Housing: 16 gauge cold rolled steel.
 Clamshell housing with completely concealed internal dropslot piano hinge.
 Finish: white TGIC polyester powder coat



L.C. Doane Company

www.lcdoane.com

SJ LED

Size: 2'
 Mounting: wall only (horizontal orientation only)
 Inner Lens: optic plus acrylic lens
 Outer Lens: 0.187 clear polycarbonate
 Housing: 16 gauge cold rolled steel
 Finish: polyester powder coat



Division 26 | Electrical

Light Fixtures, Interior, General, Surface-mounted

General Notes
See comments on previous general notes page.

Specification Notes
Coordinate lighting fixture specifications with new/existing ceiling substrate prior to ordering.

Only those models listed have been tested. Models with different options in any category warrant additional testing of a sample fixture.



Luminaire LED, Inc.
www.luminairelighting.com

Supermax Wall Mount WM11, WM12, WM13

Size: 11"x15", 11"x26", 11"x37"
Mounting: drywall ceiling & wall (horizontal orientation only)
Inner Lens: prismatic polycarbonate
Outer Lens: 0.25" clear polycarbonate
Housing: one piece die formed 14 gauge cold rolled steel
Finish: polyester powder coat

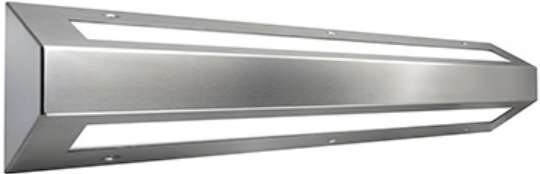

Luminaire LED, Inc.
www.luminairelighting.com

Supermax Corner Mount CM12, CM13, CM14

Size: 9"x21", 9"x35", 9"x49"
Mounting: wall only (vertical orientation must be flush to ceiling)
Inner Lens: prismatic polycarbonate
Outer Lens: 0.25" clear polycarbonate
Housing: One piece die formed 14 gauge cold rolled steel
Finish: polyester powder coat



Division 26 | Electrical

Light Fixtures, Interior, General, Surface-mounted

General Notes
See comments on previous general notes page.

Specification Notes
Coordinate lighting fixture specifications with new/existing ceiling substrate prior to ordering.

Only those models listed have been tested. Models with different options in any category warrant additional testing of a sample fixture.



Luminaire LED, Inc.
www.luminairelighting.com

Supermax Surface Mount SMP12, SMP13, SMP22, SMP23

Size: 11"x23", 11"x37", 17"x23", 17"x37"
Required Options: must specify inner and outer lens
Mounting: drywall ceiling & wall
Inner Lens: prismatic polycarbonate
Outer Lens: 0.25" clear polycarbonate
Housing: 16 gauge cold rolled steel
Finish: polyester powder coat



New Star Lighting
www.newstarlighting.com

StarTile LED MAX (AGM11, AGM14, AGM22, AGM24)

Size: 1'x1', 1'x4', 2'x2', 2'x4'
Mounting: drywall ceiling only
Inner Lens: polycarbonate
Outer Lens: 0.25" clear polycarbonate
Housing: extruded aluminum frame in 14 gauge cold rolled steel frame with beveled edges
Finish: polyester powder coat



Division 26 | Electrical

Light Fixtures, Interior, General, Surface-mounted



General Notes

See comments on previous general notes page.

Specification Notes

Coordinate lighting fixture specifications with new/existing ceiling substrate prior to ordering.

Only those models listed have been tested. Models with different options in any category warrant additional testing of a sample fixture.

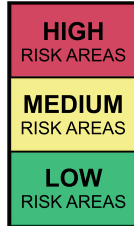

Paco Lighting

www.pacolighting.com

MURA 45"

Size: 45"

Required Options: heavy security level (H)

Mounting: drywall (horizontal orientation only)

Outer Lens: 3/8" clear polycarbonate (M5)

Inner Lens: white opal underlay (H5)

Housing: 14 gauge cold-rolled steel

Finish: baked white enamel powder coat

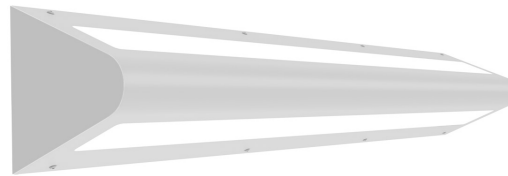

Division 26 | Electrical

Light Fixtures, Interior, General, Surface-mounted



General Notes

See comments on previous general notes page.

Specification Notes

Coordinate lighting fixture specifications with new/existing ceiling substrate prior to ordering.

Only those models listed have been tested. Models with different options in any category warrant additional testing of a sample fixture.



Luminaire LED, Inc.

www.luminairelighting.com

VPF-43, VPF-83, VPF-123

Size: 4.35" x 37.72", 8.75" x 37.72", 12.4" x 37.72"

Mounting: drywall ceiling & wall (horizontal orientation only)

Outer Lens: UV stabilized opal polycarbonate with infrared prisms.

Housing: marine grade heat treated extruded aluminum

Finish: polyester powder coat



Division 26 | Electrical

Light Fixtures, Interior, General, Surface-mounted

General Notes
See comments on previous general notes page.

Only those models listed have been tested. Models with different options in any category warrant additional testing of a sample fixture.



Kenall Manufacturing
www.kenall.com

Ranger Striplight

Note: Wedging ligature opportunity at lens and housing.

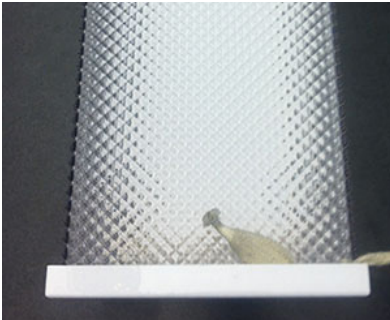

Kenall Manufacturing
www.kenall.com

Millenium Stretch MLHA8-R, MLHA12-R

Note: Manufacturer does not recommend fixture for use in Behavioral Health settings.



Kenall Manufacturing
www.kenall.com

Millenium Round MR13FL & MR17L Series, Ceiling & Wall Mount

Note: Presents opportunity for ligature in both mounting orientations.



Division 26 | Electrical

Light Fixtures, Interior, General, Surface-mounted

General Notes

See comments on previous general notes page.

Specification Notes

Coordinate lighting fixture specifications with new/existing ceiling substrate prior to ordering.

Only those models listed have been tested. Models with different options in any category warrant additional testing of a sample fixture.



Legion Lighting Co., Inc.

www.legionlighting.com

Vandalex Series 19

Note: Wedging ligature opportunity at lens and housing.

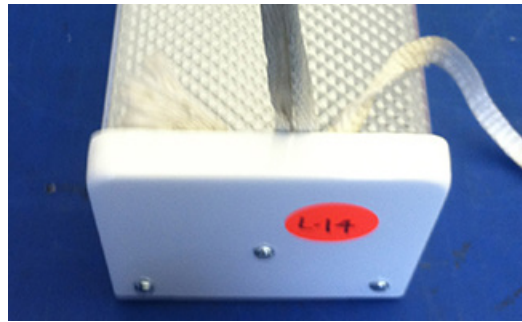

Luminaire LED, Inc.

www.luminairelighting.com

Swoop 610 Series

Note: Presents opportunity for downward ligature in both mounting orientations.



Division 26 | Electrical

Light Fixtures, Interior, General, Recessed

General Notes
See comments on previous general notes page.

Specification Notes
Coordinate lighting fixture specifications with new/existing ceiling substrate prior to ordering.

Only those models listed have been tested. Models with different options in any category warrant additional testing of a sample fixture.



Advantage Environmental Lighting

www.aelnow.com/

CLD24 Recessed LED Clean Room

Size: 2'x4'
 Mounting: drywall and metal security ceiling
 Outer Lens: 0.187" clear polycarbonate
 Inner Lens: 0.125" prismatic polycarbonate
 Housing: 0.063" aluminum and 18 gauge stainless steel door
 Finish: white TGIC polyester powder coat



Amico Lighting Solutions

www.amico.com

Behavioral Solar Duo Med Multifunction LED

Size: 6"x48"
 Required Options: VRA (vandal resistant; 0.118" clear polycarbonate)
 Mounting: drywall and metal security ceiling
 Outer Lens: 0.118" clear polycarbonate
 Housing: 20 gauge cold rolled steel
 Finish: white urethane powder coat finish, hospital grade

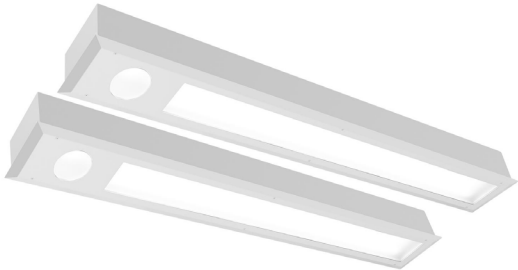

Division 26 | Electrical

Light Fixtures, Interior, General, Recessed

General Notes

See comments on previous general notes page.

Specification Notes

Coordinate lighting fixture specifications with new/existing ceiling substrate prior to ordering.

Only those models listed have been tested. Models with different options in any category warrant additional testing of a sample fixture.



Amico Lighting Solutions

www.amico.com

Behavioral Solar Eclipse Multifunction LED

Size: 2'x2', 2'x4'
 Required Options: VRA (vandal resistant; 0.118" clear polycarbonate)
 Mounting: drywall and metal security ceiling
 Outer Lens: 0.118" clear polycarbonate
 Housing: 20 gauge cold rolled steel
 Finish: white urethane powder coat finish, hospital grade

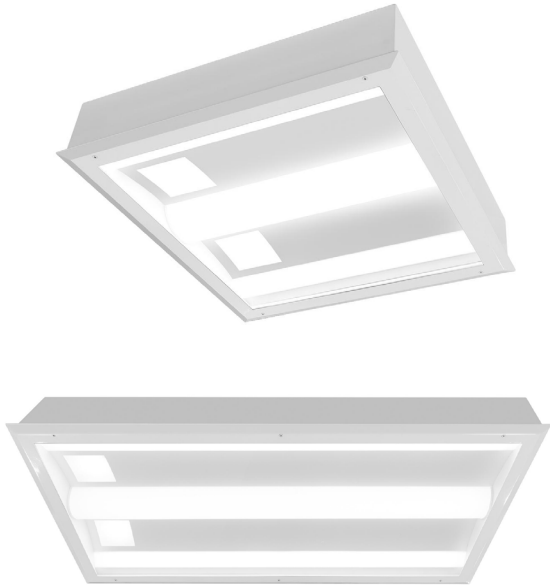

Cooper Lighting Solutions

www.cooperlighting.com

Fail-Safe FMR HS LED Recessed Flange Confinement

Size: 1'x1', 1'x2', 1'x4', 2'x2', 2'x4'
 Required Options: HS (high security)
 Mounting: drywall and metal security ceiling
 Inner Lens: prismatic polycarbonate
 Outer Lens: clear polycarbonate
 Housing: 16 gauge die-formed cold rolled steel body with welded corners.
 Finish: polyester powder coat



Division 26 | Electrical

Light Fixtures, Interior, General, Recessed

General Notes
See comments on previous general notes page.

Specification Notes
Coordinate lighting fixture specifications with new/existing ceiling substrate prior to ordering.

Only those models listed have been tested. Models with different options in any category warrant additional testing of a sample fixture.



Cooper Lighting Solutions

www.cooperlighting.com

Fail-Safe FSN6 4ft Shallow Plenum

Size: 6"x48"
Mounting: drywall
Outer Lens: 0.25" clear polycarbonate
Housing: aluminum extruded frame
Finish: standard white



Hubbell Lighting

www.hubbellhealthcare.com

MediMode Behavioral

Size: 2'x4'
Mounting: drywall and metal security ceiling
Outer Lens: 0.25" clear polycarbonate
Housing: 20 gauge seam welded cold rolled steel housing with 18 gauge cold rolled steel flange. 18 gauge cold rolled steel door frame
Finish: Polyester white powder coat with antimicrobial additive



Division 26 | Electrical

Light Fixtures, Interior, General, Recessed

General Notes
See comments on previous general notes page.

Specification Notes
Coordinate lighting fixture specifications with new/existing ceiling substrate prior to ordering.

Only those models listed have been tested. Models with different options in any category warrant additional testing of a sample fixture.



Kenall Manufacturing
www.kenall.com

**MedMaster Behavioral Health
MMAC14, MMAC22, MMAC24**

Size: 1'x4', 2'x2', 2'x4'
Mounting: drywall and metal security ceiling
Inner Lens: (standard) extruded high efficiency frosted DR acrylic
Outer Lens: 0.187" clear polycarbonate
Housing: 14 gauge cold rolled steel, spot welded.
Finish: TGIC polyester powder coat



Kenall Manufacturing
www.kenall.com

Mighty Mac RMCA, RMCD, RQCA Series

Size: 1'x2', 1'x4', 1'x1', 2'x2', 2'x4'
Required Options: white fasteners
Mounting: drywall and metal security ceiling
Inner Lens: 0.125" prismatic polycarbonate
Outer Lens: 0.125" clear polycarbonate
Housing: 16 gauge cold rolled steel
Finish: TGIC polyester powder coat



Division 26 | Electrical

Light Fixtures, Interior, General, Recessed

General Notes
See comments on previous general notes page.

Specification Notes
Coordinate lighting fixture specifications with new/existing ceiling substrate prior to ordering.

Only those models listed have been tested. Models with different options in any category warrant additional testing of a sample fixture.



Kenall Manufacturing
www.kenall.com

MedMaster Behavioral Health SafeSlot Luminaire BHAERS4

Size: 4"x4' (2)
Required Options: FL (Flange)
Mounting: drywall and metal security ceiling
Outer Lens: 0.187" clear polycarbonate
Housing: extruded aluminum
Finish: TGIC polyester powder coat

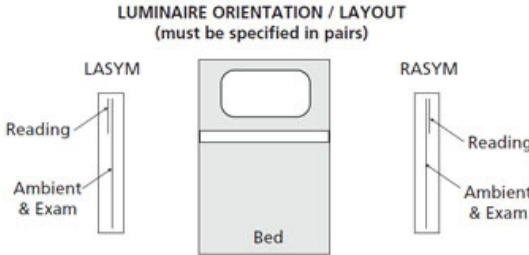

Kenall Manufacturing
www.kenall.com

MedMaster Behavioral Health SafeSlot Luminaire BHRS4

Size: 2', 3', 4', 6', 8'
Required Options: FL (flange)
Mounting: drywall and metal security ceiling
Outer Lens: 0.187" diffused polycarbonate
Housing: extruded aluminum
Finish: TGIC polyester powder coat



Division 26 | Electrical

Light Fixtures, Interior, General, Recessed

General Notes
See comments on previous general notes page.

Specification Notes
Coordinate lighting fixture specifications with new/existing ceiling substrate prior to ordering.

Only those models listed have been tested. Models with different options in any category warrant additional testing of a sample fixture.



Kurtzon
www.kurtzon.com

VL-RB-LED

Size: 2'x2'
Required Options: RB (recessed basket)
Mounting: drywall and metal security ceiling
Outer Lens: 0.125" clear flat polycarbonate
Housing: 18 gauge cold rolled steel housing and door.
Finish: polyester powder coat



Luminaire LED, Inc.
www.luminairelighting.com

Supermax Recessed Mount RM12, RM22

Size: 1'x2', 2'x2'
Mounting: drywall and metal security ceiling
Inner Lens: 0.156" prismatic polycarbonate
Outer Lens: 0.25" clear polycarbonate
Housing: 16 gauge cold rolled steel housing and 14 gauge cold rolled steel door
Finish: polyester powder coat



Division 26 | Electrical

Light Fixtures, Interior, General, Recessed

General Notes

See comments on previous general notes page.

Specification Notes

Coordinate lighting fixture specifications with new/existing ceiling substrate prior to ordering.

Only those models listed have been tested. Models with different options in any category warrant additional testing of a sample fixture.



Lux Illuminaire

www.luxilluminaire.com

EOS4.0-R-4 4ft Recessed Vandal

Size: 4'
 Required Options: FT flange trim
 Mounting: drywall ceiling
 Inner Lens: n/a
 Outer Lens: frosted polycarbonate
 Housing: extruded aluminum
 Finish: white polyester powder coat

Caution Note: Tamper resistant sealant shall be provided around entire perimeter of fixture for security against ceiling substrate.



L.C. Doane Company

www.lcdoane.com

CRC 2x2

Size: 2'x2'
 Mounting: drywall and metal security ceiling
 Inner Lens: optic plus acrylic lens
 Outer Lens: 0.187 clear polycarbonate
 Housing: 18 ga cold rolled steel
 Finish: polyester powder coat



Division 26 | Electrical

Light Fixtures, Interior, General, Recessed

General Notes
See comments on previous general notes page.

Specification Notes
Coordinate lighting fixture specifications with new/existing ceiling substrate prior to ordering.

Only those models listed have been tested. Models with different options in any category warrant additional testing of a sample fixture.



New Star Lighting
www.newstarlighting.com

**Confinement Series
37M and 57M Models**

Size: 2'x2' (37M); 1'x1' (57M)
Mounting: drywall and metal security ceiling
Inner Lens: 0.125" prismatic polycarbonate
Outer Lens: 0.25" clear polycarbonate
Housing: Die formed 16gauge cold rolled steel, seam welded and ground smooth.
Finish: polyester powder coat

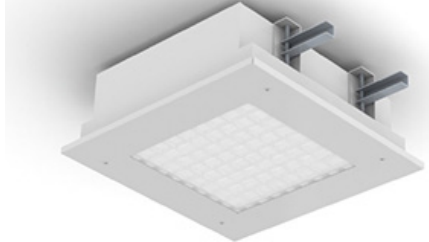
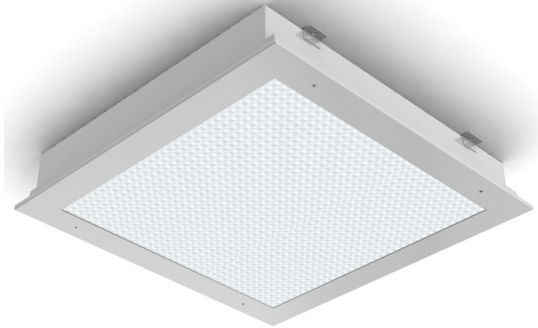

New Star Lighting
www.newstarlighting.com

**AuraMed AATB14, AATB22,
AATB24**

Size: 1'x4', 2'x2', 2'x4'
Required Options: O (overlapped door frame)
Mounting: drywall and metal security ceiling
Inner Lens: (standard) opal polycarbonate
Outer Lens: 0.25" clear polycarbonate
Housing: 16 gauge cold rolled steel
Finish: polyester powder coat



Division 26 | Electrical

Light Fixtures, Interior, General, Recessed

General Notes
See comments on previous general notes page.

Specification Notes
Coordinate lighting fixture specifications with new/existing ceiling substrate prior to ordering.

Only those models listed have been tested. Models with different options in any category warrant additional testing of a sample fixture.



Paco Lighting
www.pacolighting.com

MRPA4 Behavioral LED

Size: 2'x2', 2'x4'
Required Options: M security level; PB (perforated basket); F (flange)
Mounting: drywall ceiling
Inner lens: n/a
Outer Lens: 0.25" clear polycarbonate (M4)
Housing: 16 gauge with 14 gauge faceplate
Finish: white polyester powder coat



Paco Lighting
www.pacolighting.com

MRGA1 Behavioral Center Lens Recessed LED, 1x4, 2x2, 2x4

Size: 1'x4', 2'x2', 2'x4'
Mounting: drywall and metal security ceiling
Outer Lens: 0.250" clear polycarbonate
Housing: 16 gauge cold rolled steel with continuously welded end plates; 14 gauge die formed door frame with tamper resistant fasteners
Finish: white antimicrobial paint



Division 26 | Electrical

Light Fixtures, Interior, General, Recessed

General Notes

See comments on previous general notes page.

Specification Notes

Coordinate lighting fixture specifications with new/existing ceiling substrate prior to ordering.

Only those models listed have been tested. Models with different options in any category warrant additional testing of a sample fixture.

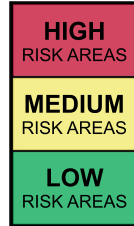

Visa Lighting

www.visalighting.com

Serenity High Abuse CM1922, CM1924

Size: 2'x2', 2'x4'

Required Options: High Abuse

Mounting: drywall and metal security ceiling
Inner Lens: 0.118" satin ice acrylic with vinyl laminate pattern diffuser

Outer Lens: 0.118" clear polycarbonate

Housing: steel housing and aluminum mud flange

Finish: antimicrobial powder coat

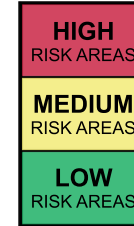

Visa Lighting

www.visalighting.com

Symmetry General Use Behavioral Health CM1988-W

Size: 24"

Mounting: drywall and metal security
Outer Lens: 0.1875" high impact clear polycarbonate

Housing: steel housing and aluminum mud flange

Finish: antimicrobial powder coat



Division 26 | Electrical

Light Fixtures, Interior, General, Recessed

General Notes
See comments on previous general notes page.

Specification Notes
Coordinate lighting fixture specifications with new/existing ceiling substrate prior to ordering.

Only those models listed have been tested. Models with different options in any category warrant additional testing of a sample fixture.



Visa Lighting
www.visalighting.com

Visage Behavioral Health Flush CV1680

Size: 4.5" x 48"
Required Options: TRS (tamper resistant fasteners)
Mounting: drywall (ceiling & wall) and metal security ceiling
Outer Lens: clear polycarbonate
Housing: extruded aluminum
Finish: antimicrobial powder coat



Visa Lighting
www.visalighting.com

Lenga Behavioral Health Flush CM2062

Size: 4.5" x 48"
Required Options: FLGD (flanged drywall ceiling)
Mounting: drywall and metal security ceiling
Inner Lens: acrylic lens
Outer Lens: clear polycarbonate
Housing: extruded aluminum
Finish: antimicrobial powder coat



Division 26 | Electrical

Light Fixtures, Interior, General, Recessed

General Notes

See comments on previous general notes page.

Specification Notes

Coordinate lighting fixture specifications with new/existing ceiling substrate prior to ordering.

Only those models listed have been tested. Models with different options in any category warrant additional testing of a sample fixture.



Viscor

www.viscor.com

Certolux VRUO

Size: 1'x4', 2'x2', 2'x4'
 Required Options: O (overlapping door)
 Mounting: drywall and metal security ceiling
 Inner Lens: may vary
 Outer Lens: .125 clear polycarbonate
 Housing: 16 gauge cold rolled steel
 Finish: polyester powder coat

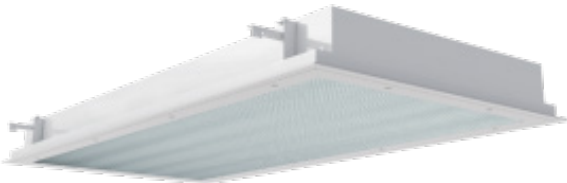

Viscor

www.viscor.com

Certolux MBH1 2x2

Size: 2'x2'
 Required Options: I (inset door)
 Mounting: drywall and metal security ceiling
 Inner Lens: contoured diffuse polycarbonate
 Outer Lens: .250 clear polycarbonate
 Housing: 20 gauge cold rolled steel with 18 gauge flange
 Finish: gloss white polyester powder coat



Division 26 | Electrical

Light Fixtures, Interior, General, Recessed



General Notes

See comments on previous general notes page.

Specification Notes

Coordinate lighting fixture specifications with new/existing ceiling substrate prior to ordering.

Only those models listed have been tested. Models with different options in any category warrant additional testing of a sample fixture.



Viscor

www.viscor.com

Circular Troffer, LTDCR

Size: 2'x2'
Required Options: C87; P02/P08 (polycarbonate lens); C03 (tamper resistant fasteners)
Mounting: drywall and metal security ceiling
Inner Lens: acrylic
Outer Lens: .25" polycarbonate
Housing: steel
Finish: white polyester powder coat



Division 26 | Electrical

Light Fixtures, Interior, General, Recessed

General Notes

See comments on previous general notes page.

Specification Notes

Coordinate lighting fixture specifications with new/existing ceiling substrate prior to ordering.

Only those models listed have been tested. Models with different options in any category warrant additional testing of a sample fixture.



Amico Lighting Solutions

www.amico.com

Behavioral Solar Duo Med Multifunction LED

Size: 6"x48"
 Required Options: VRA (vandal resistant; 0.118" clear polycarbonate)
 Mounting: lay-in grid ceilings
 Outer Lens: 0.118" clear polycarbonate
 Housing: 20 gauge cold rolled steel
 Finish: white urethane powder coat finish, hospital grade

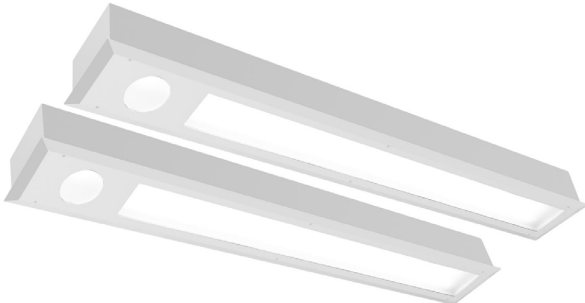

Amico Lighting Solutions

www.amico.com

Behavioral Solar Eclipse Multifunction LED

Size: 2'x2', 2'x4'
 Required Options: VRA (vandal resistant; 0.118" clear polycarbonate)
 Mounting: lay-in grid ceilings
 Outer Lens: 0.118" clear polycarbonate
 Housing: 20 gauge cold rolled steel
 Finish: white urethane powder coat finish, hospital grade

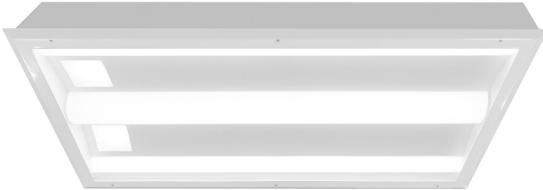

Division 26 | Electrical

Light Fixtures, Interior, General, Recessed

General Notes

See comments on previous general notes page.

Specification Notes

Coordinate lighting fixture specifications with new/existing ceiling substrate prior to ordering.

Only those models listed have been tested. Models with different options in any category warrant additional testing of a sample fixture.



Cooper Lighting Solutions

www.cooperlighting.com

FSP HS Shallow Plenum

Size: 2'x4'
 Required Options: HS (high security)
 Mounting: lay-in grid ceilings
 Outer Lens: 0.25" clear polycarbonate
 Housing: aluminum & steel (above ceiling)

Installation Note: Apply tamper-resistant sealant around perimeter, between ceiling opening and fixture edge.



Paco Lighting

www.pacolighting.com

MRGA1 Behavioral Center Lens Recessed LED, 1x4, 2x2, 2x4

Size: 1'x4', 2'x2', 2'x4'
 Mounting: lay-in grid ceilings
 Outer Lens: 0.250" clear polycarbonate
 Housing: 16 gauge cold rolled steel with continuously welded end plates; 14 gauge die formed door frame with tamper resistant fasteners
 Finish: white antimicrobial paint



Division 26 | Electrical

Light Fixtures, Interior, General, Recessed

General Notes

See comments on previous general notes page.

Only those models listed have been tested. Models with different options in any category warrant additional testing of a sample fixture.



Cooper Lighting Solutions

www.cooperlighting.com

Fail-Safe ENV HS (DFVR)

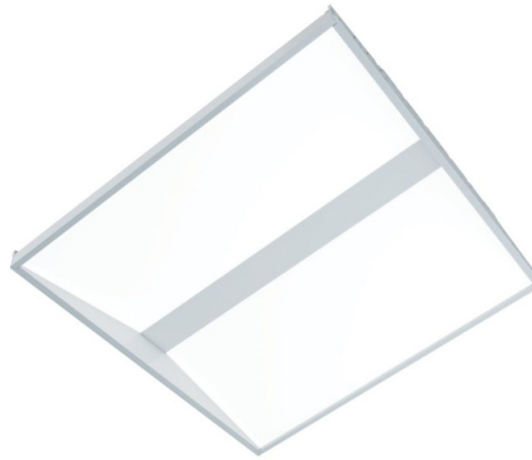

Selux Corporation

www.selux.com

M125 LED Recessed (L125R1)

Size: 3', 4'

Mounting: drywall and metal security ceiling

Outer Lens: prismatic polycarbonate

Housing: Continuous extruded aluminum,

Die cast aluminum end caps made from low copper marine grade aluminum alloy

Finish: polyester powder coat



Division 26 | Electrical

Light Fixtures, Interior, General, Recessed

General Notes

See comments on previous general notes page.

Only those models listed have been tested. Models with different options in any category warrant additional testing of a sample fixture.



Cooper Lighting Solutions

www.cooperlighting.com

Failsafe SGI LED

Note: Light fixture housing construction at flange corners can be manipulated overtime. Gasket at lens and door comes out after repeated wedging and tampering.



Legion Lighting Co., Inc.

www.legionlighting.com

Securlume Series 672

Note: Fixture provides multiple ligature points and is not tamper-resistant.

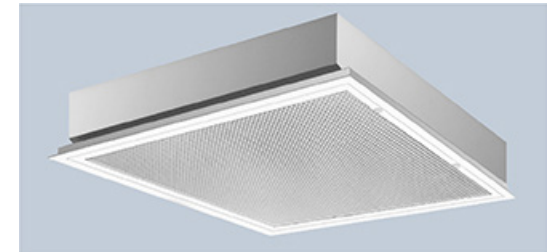

Division 26 | Electrical

Light Fixtures, Interior, General, Recessed

General Notes

See comments on previous general notes page.

Only those models listed have been tested. Models with different options in any category warrant additional testing of a sample fixture.



Philips Day-Brite

www.signify.com/en-us

Attune Series

Note: A polycarbonate lens is no longer available as an option.



Pixi Lighting

www.pixilighting.com

Flatlight Luminaire

Notes:

- Edges of housing allow for ligation.
- Gasketing material can be picked and removed.



Division 26 | Electrical

Light Fixtures, Interior, Task Lighting

General Notes

See comments on previous general notes page.

Specification Notes

Coordinate lighting fixture specifications with new/existing ceiling substrate prior to ordering.

Only those models listed have been tested. Models with different options in any category warrant additional testing of a sample fixture.



Cooper Lighting Solutions

www.cooperlighting.com

FLD6B HS LED Downlight

Size: 6"
 Required Options: vandal resistant enclosed bottom trim ring; HS (high security)
 Mounting: drywall ceiling
 Inner Lens: 0.06" frosted polycarbonate
 Outer Lens: 0.125" clear polycarbonate
 Housing: cast aluminum
 Finish: matte white



H.E. Williams

www.hew.com

V6DR 6" Vandal-Resistant Downlight - Round

Size: 6"
 Required Options: flush lens trim type (L); 1/2" standard flange type (OF)
 Mounting: drywall and metal security ceiling
 Inner Lens: polycarbonate
 Housing: textured white trim flange (MWT)
 Finish: clear semi-specular powder coat



Division 26 | Electrical

Light Fixtures, Interior, Task Lighting

General Notes

See comments on previous general notes page.

Specification Notes

Coordinate lighting fixture specifications with new/existing ceiling substrate prior to ordering.

Only those models listed have been tested. Models with different options in any category warrant additional testing of a sample fixture.



H.E. Williams

www.hew.com

4DR Tunable Color 4.5" Downlight, Round

Size: 4.5"
 Required Options: "tamper proof" regressed lens (R); standard flange (OR)
 Mounting: drywall and metal security ceiling
 Inner Lens: polycarbonate
 Housing: low-iridescent anodized aluminum reflector; die-cast aluminum frame trim
 Finish: clear semi-specular standard.



Kenall Manufacturing

www.kenall.com

HADL6 & BHDL6 Millenium Downlight

Size: 6"
 Mounting: drywall ceilings
 Inner Lens: diffused tempered-glass
 Outer Lens: 0.125" clear polycarbonate
 Housing: 18 gauge corrosion-resistant steel
 Finish: flat powder coat.

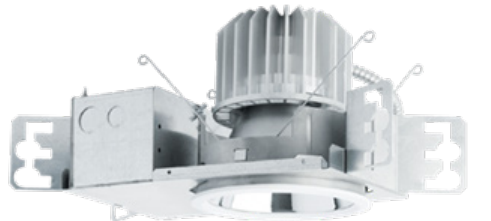
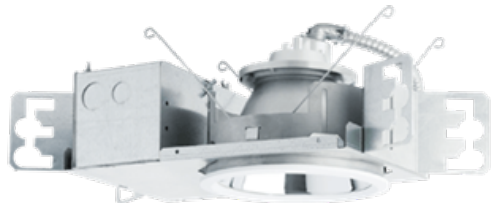

Division 26 | Electrical

Light Fixtures, Interior, Task Lighting

General Notes

See comments on previous general notes page.

Specification Notes

Coordinate lighting fixture specifications with new/existing ceiling substrate prior to ordering.

Only those models listed have been tested. Models with different options in any category warrant additional testing of a sample fixture.



The Kirlin Company

www.kirlinlighting.com

LRR-06020 6" LED Downlight

Size: 6"
 Required Options: -25 (vandal resistant trim, hardware and lensing)
 Mounting: drywall ceilings
 Inner Lens: high strength prismatic acrylic
 Outer Lens: 0.125" clear flat polycarbonate
 Housing: acrylic enameled aluminum housing; seamless tapered aluminum self-flanged rigid cast trim
 Finish: standard white



The Kirlin Company

www.kirlinlighting.com

Vandal Resistant Downlight, LRV-07469 (7") & LRV-08470 (8")

Size: 7", 8" (shallow plenum applicable)
 Mounting: drywall ceilings
 Inner Lens: clear prismatic acrylic
 Outer Lens: 0.125" clear flat polycarbonate
 Housing: vandal resistant smooth white seamless tapered aluminum self-flanged flare trim
 Finish: standard



Division 26 | Electrical

Light Fixtures, Interior, Task Lighting

General Notes

See comments on previous general notes page.

Specification Notes

Coordinate lighting fixture specifications with new/existing ceiling substrate prior to ordering.

Only those models listed have been tested. Models with different options in any category warrant additional testing of a sample fixture.



The Kirlin Company

www.kirlinlighting.com

LRC-04VND 4" Downlight

Size: 4"
 Required Options: TR (tamper resistant); NC (new construction with ceiling fitting plate)
 Mounting: drywall
 Outer Lens: 0.22" clear polycarbonate
 Housing: acrylic enameled aluminum
 Finish: standard white



Kurtzon

www.kurtzon.com

VL PBD 6" LED Behavioral Downlight

Size: 6"
 Required Options: tamper-resistant fasteners
 Mounting: drywall ceilings
 Outer Lens: clear non-prismatic 0.125" virgin polycarbonate silicone
 Housing: stainless steel body and spun aluminum housing and plaster frame. 16 gauge stainless steel formed door frame
 Finish: antimicrobial polyester powder coat



Division 26 | Electrical

Light Fixtures, Interior, Task Lighting

General Notes

See comments on previous general notes page.

Specification Notes

Coordinate lighting fixture specifications with new/existing ceiling substrate prior to ordering.

Only those models listed have been tested. Models with different options in any category warrant additional testing of a sample fixture.



Ledra Brands

www.ledrabrands.com

NU4 Round & NU6 Round

Size: 4", 6"
 Required Options: TR (tamper resistant); NC (new construction with ceiling fitting plate)
 Mounting: drywall
 Outer Lens: clear polycarbonate
 Housing: 16 ga cold rolled steel
 Finish: white



Lighthouse Lighting

www.lighthouselighting.com

Guardian Round Downlight & Wall Wash 2-116-T

Size: 3.5"
 Mounting: drywall
 Outer Lens: 3/16" clear polycarbonate
 Housing: machined aluminum
 Finish: standard powder coated white



Division 26 | Electrical

Light Fixtures, Interior, Task Lighting

General Notes

See comments on previous general notes page.

Specification Notes

Coordinate lighting fixture specifications with new/existing ceiling substrate prior to ordering.

Only those models listed have been tested. Models with different options in any category warrant additional testing of a sample fixture.

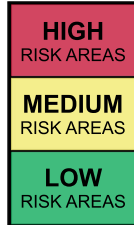

Lightheaded Lighting

www.lightheadedlighting.com

Guardian Square Downlight & Wall Wash 2-516-T

Size: 3.5"
Mounting: drywall
Outer Lens: 3/16" clear polycarbonate
Housing: machined aluminum
Finish: standard powder coated white



Lightolier by Signify

www.lightingproducts.signify.com

Calculite LED 4" & 6" Gen3 Downlight

Size: 4", 6"
Required Options: C4RVPWH/C6RVPWH (IP65 rated vandal proof matte white accessory); (F) flangeless trim
Mounting: drywall ceilings
Outer Lens: clear polycarbonate
Housing: machine aluminum ring
Finish: standard matte white



Division 26 | Electrical

Light Fixtures, Interior, Task Lighting

General Notes

See comments on previous general notes page.

Specification Notes

Coordinate lighting fixture specifications with new/existing ceiling substrate prior to ordering.

Only those models listed have been tested. Models with different options in any category warrant additional testing of a sample fixture.



New Star Lighting

www.newstarlighting.com

DLM6 Downlight StarMed Series

Size: 6"
Required Options: TH (torx head screws)
Mounting: drywall ceilings
Inner Lens: 0.125" prismatic acrylic
Outer Lens: 0.250" clear polycarbonate
Housing: 16 gauge painted steel housing and trim
Finish: standard white antimicrobial powder coat



Paco Lighting

www.pacolighting.com

MDA4 4" Downlight

Size: 4"
Mounting: drywall
Outer Lens: 1/4" clear polycarbonate
Housing: semi specular reflector
Finish: matte white trim



Division 26 | Electrical

Light Fixtures, Interior, Task Lighting

General Notes

See comments on previous general notes page.

Specification Notes

Coordinate lighting fixture specifications with new/existing ceiling substrate prior to ordering.

Only those models listed have been tested. Models with different options in any category warrant additional testing of a sample fixture.



Visa Lighting

www.visalighting.com

Gig Task Light CB1800-BH1

Size: 3.75"x6.75"
 Required Options: BH1 (behavioral health high abuse mounting bracket)
 Mounting: wall (downlight only)
 Outer Lens: 0.25" polycarbonate lens with gel gasket
 Housing: cast aluminum
 Finish: powder coat



Visa Lighting

www.visalighting.com/

Sole Recessed Illuminated Mirror, Oval & Rectangle

Size: 20"x30" (rectangle), 24"x34" (oval)
 Outer Lens: impact resistant 6mm polycarbonate mirror with abrasion resilient silicone hard coating for scratch resistance
 Housing: Stainless steel frame, heavy gauge fabricated aluminum back box
 Finish: powder coat



Division 26 | Electrical

Light Fixtures, Interior, Task Lighting

General Notes

See comments on previous general notes page.

Only those models listed have been tested. Models with different options in any category warrant additional testing of a sample fixture.



Designplan Lighting, Inc.

www.designplan.com

RDL/RHL Downlight

Note: Installation may allow gasketing to be compromised.



Designplan Lighting, Inc.

www.designplan.com

Resistant Downlights RDD, RDO, RDP, & RDW Vandal

Note: Installation may allow gasketing to be compromised.



Division 26 | Electrical

Light Fixtures, Interior, Task Lighting



Office of
Mental Health

General Notes

See comments on previous general notes page.

Only those models listed have been tested. Models with different options in any category warrant additional testing of a sample fixture.



Kenall Manufacturing

www.kenall.com

Stratalume UC Series, UC SL

Size: 5"x12", 5"x24", 5"x36", 5"x48"

Required Options: polycarbonate lens

Mounting: drywall ceilings

Outer Lens: 0.125" prismatic polycarbonate lens

Housing: 1.1" profile, 20 gauge cold rolled steel.

Finish: TGIC polyester powder coat

Note: Manufacturer does not recommend fixture for use in Behavioral Health settings.



Division 26 | Electrical

Light Fixtures, Interior, Night Lighting

General Notes

See comments on previous general notes page.

Amber colored LEDs are recommended at patient bedrooms.

Night lights are recommended to be installed 12"-18" above finish floor for proper use and to minimize potential ligature risk.

Only those models listed have been tested. Models with different options in any category warrant additional testing of a sample fixture.



Amico Lighting Solutions

www.amico.com

Lunar Decorative Wall Mount LED Night Light

Size: 4.5"x2.75"
 Mounting: wall
 Outer Lens: polycarbonate
 Housing: die-cast aluminum
 Finish: antimicrobial powder coat



Cooper Lighting Solutions

www.cooperlighting.com

Fail-Safe MSN Night Light

Size: 3"x5"
 Required Options: tamper-resistant fasteners
 Outer Lens: acrylic
 Housing: die cast aluminum face plate
 Finish: standard painted

Caution: Product has an acrylic lens, versus typical recommendation of polycarbonate. However, small sized lens resisted breakage during testing.



Division 26 | Electrical

Light Fixtures, Interior, Night Lighting

General Notes

See comments on previous general notes page.

Amber colored LEDs are recommended at patient bedrooms.

Night lights are recommended to be installed 12"-18" above finish floor for proper use and to minimize potential ligature risk.

Only those models listed have been tested. Models with different options in any category warrant additional testing of a sample fixture.



Elcast Lighting

www.elcastlgt.com

Series 1216-1-F

Size: 3.10"x7.10"
 Required Options: tamper-resistant fasteners
 Outer Lens: polycarbonate
 Housing: cast aluminum housing and frame
 Finish: polyester powder coating on zinc based primer



Hubbell Lighting

www.hubbellhealthcare.com

NiteWay Night Light - Vertical, Horizontal

Size: 3"x5", 5"x3"
 Required Options: tamper-resistant fasteners
 Outer Lens: polycarbonate optical lens
 Housing: die cast aluminum faceplate; 0.05 aluminum backplate
 Finish: antimicrobial polyester powder coat



Division 26 | Electrical

Light Fixtures, Interior, Night Lighting

General Notes

See comments on previous general notes page.

Amber colored LEDs are recommended at patient bedrooms.

Night lights are recommended to be installed 12"-18" above finish floor for proper use and to minimize potential ligature risk.

Only those models listed have been tested. Models with different options in any category warrant additional testing of a sample fixture.



Kenall Manufacturing

www.kenall.com

MedMaster SoftStep Contour Steplight, MCSL

Size: varies
 Outer Lens: pearlescent polycarbonate
 Housing: die cast aluminum. Reflector is die cast aluminum with integral heat sink.
 Finish: antimicrobial polyester powder coat



Kenall Manufacturing

www.kenall.com

MedMaster SoftStep Steplight MSL

Size: 4"x10"
 Required Options: MSL (standard model); (L) Internal Louver; AL (anti-ligature lens)
 Outer Lens: polycarbonate
 Housing: 18 gauge cold rolled steel
 Finish: polyester powder coat



Division 26 | Electrical

Light Fixtures, Interior, Night Lighting



General Notes

See comments on previous general notes page.

Amber colored LEDs are recommended at patient bedrooms.

Night lights are recommended to be installed 12"-18" above finish floor for proper use and to minimize potential ligature risk.

Only those models listed have been tested. Models with different options in any category warrant additional testing of a sample fixture.



The Kirlin Company

www.kirlinlighting.com

MNS-05924-26 Square StepLight LED

Size: 5"x5"

Required Options: "26" (faceplate secured with tamperproof screws)

Outer Lens: 2" diameter translucent white 1/8" polycarbonate

Housing: 4" x 2-1/4" standard octagon galvanized steel outlet box with gasketed rustproof aluminum trim faceplate.

Finish: white standard



Division 26 | Electrical

Light Fixtures, Interior, Night Lighting



General Notes

See comments on previous general notes page.

Amber colored LEDs are recommended at patient bedrooms.

Night lights are recommended to be installed 12"-18" above finish floor for proper use and to minimize potential ligature risk.

Only those models listed have been tested. Models with different options in any category warrant additional testing of a sample fixture.



Philips Alkco

www.lightingproducts.philips.com

WayGlo WG2H

Note: Acrylic lens can be easily broken into small shards.



Division 26 | Electrical Light Fixtures, Exit Signage

General Notes

See comments on previous general lighting fixtures page.

Must be positively and mechanically attached, not friction fit. Specify fully recessed housing when available.

Ceiling mounted exit lights shall be installed with mounting bracket that is full length of light box. No gaps shall be present between light box and mounting bracket or mounting bracket and ceiling.

Side mounted exit lights are prohibited.

Specification Notes

Coordinate exit signage specifications with new/existing ceiling substrate prior to ordering.

Only those models listed have been tested. Models with different options in any category warrant additional testing of a sample fixture.



Kenall Manufacturing

www.kenall.com

**Millenium Metrex METSR Series
Exit Light (Recessed)**

Diffuser|Lens: .188” thick clear polycarbonate.
Housing: 20 gauge Cold rolled steel one piece welded construction.
Finish: painted white, black or brushed stainless steel.



Kenall Manufacturing

www.kenall.com

**Millenium Metrex METSW Series
Exit Light (Wall Mount)**

Diffuser|Lens: UV stabilized, high impact, .120” thick injection molded clear polycarbonate.
Housing: High impact injection molded polycarbonate.



Division 26 | Electrical Light Fixtures, Exit Signage

General Notes

See comments on previous general lighting fixtures page.

Must be positively and mechanically attached, not friction fit. Specify fully recessed housing when available.

Ceiling mounted exit lights shall be installed with mounting bracket that is full length of light box. No gaps shall be present between light box and mounting bracket or mounting bracket and ceiling.

Side mounted exit lights are prohibited.

Specification Notes

Coordinate exit signage specifications with new/existing ceiling substrate prior to ordering.

Only those models listed have been tested. Models with different options in any category warrant additional testing of a sample fixture.



Kenall Manufacturing

www.kenall.com

**Millenium Metrex METSS
Exit Light (Wall Mount)**

Diffuser|Lens: 0.120" high impact polycarbonate
Housing: injection molded polycarbonate
Finish: painted white or black



Kenall Manufacturing

www.kenall.com

**Mighty Mac MMEX Series
Exit Light (Wall and Ceiling Mount)**

Diffuser|Lens: .188" thick clear polycarbonate.
Housing: One piece die formed 14 gauge steel continuously seam welded.



Division 26 | Electrical Light Fixtures, Exit Signage

General Notes

See comments on previous general lighting fixtures page.

Must be positively and mechanically attached, not friction fit. Specify fully recessed housing when available.

Ceiling mounted exit lights shall be installed with mounting bracket that is full length of light box. No gaps shall be present between light box and mounting bracket or mounting bracket and ceiling.

Side mounted exit lights are prohibited.

Specification Notes

Coordinate exit signage specifications with new/existing ceiling substrate prior to ordering.

Only those models listed have been tested. Models with different options in any category warrant additional testing of a sample fixture.



Barron Lighting Group

www.barronltg.com

S900 Series Edge-Lit Exit

Diffuser|Lens: Clear acrylic with leveled lettering for maximum light output. Exit letters are 6" high with 3/4" stroke.
Housing: Extruded aluminum supplied with galvanized steel adjustable bar hanger assembly.

Note: Pivoting feature creates looping ligature opportunity.



Philips Chloride

www.lightingproducts.philips.com

Caliber Series Edge Lit Exit

Diffuser|Lens: High impact acrylic, silk screened.
Housing: Premium die cast aluminum with recessed mounting.

Note: Lens is not mechanically fastened into housing. Fixture installation has inherit ligature risks.



Division 26 | Electrical Light Fixtures, Exit Signage

General Notes

See comments on previous general lighting fixtures page.

Must be positively and mechanically attached, not friction fit. Specify fully recessed housing when available.

Ceiling mounted exit lights shall be installed with mounting bracket that is full length of light box. No gaps shall be present between light box and mounting bracket or mounting bracket and ceiling.

Side mounted exit lights are prohibited.

Specification Notes

Coordinate exit signage specifications with new/existing ceiling substrate prior to ordering.

Only those models listed have been tested. Models with different options in any category warrant additional testing of a sample fixture.



Philips Chloride

www.lightingproducts.philips.com

CE-11500 SC Series Exit Light

Diffuser|Lens: No lens provided.

Housing: Two piece die cast aluminum with chevron cutouts.

Finish: Epoxy based powder coat or brushed aluminum.

Note: Cutout letters/chevrons allow access to interior of fixture.



Philips Chloride

www.lightingproducts.philips.com

CE-11500 SC Series Recessed Exit Light

Diffuser|Lens: Polycarbonate/Lens.

Housing: Two-piece die cast aluminum with 18 gauge recessed back box and vandal resistant lens.

Finish: Epoxy based powder coat or brushed aluminum.

Note: Lens does not sit flush inside recessed back box for tight and secure fit.



Division 27 | Communications

Wireless Routers



General Notes

At this time, NYS-OMH is not aware of any patient-safe WAP enclosures that are compatible with NYS ITS wireless routers.

Division 27 | Communications

Clocks

Installation Notes

It is recommended to specify recessed wall clocks with polycarbonate lenses.



Sapling Synchronized Clock Systems

www.sapling-inc.com



Analog 12" Square Clock (SAL, SAP, SAW, SAM)

Required Options: Analog Flush Mount Housing Kit, V1.0 (A-FLUSH-MNT-12S-KIT-1) with polycarbonate lens
Shape: square
Clock Lens: 0.12" clear polycarbonate
Mounting: flush



Sapling Synchronized Clock Systems

www.sapling-inc.com



Digital Clock (SBP, SBD)

Required Options: Digital Flush Mounted Polycarbonate Frame, V1.0 (D-XXX-FIL-XXX-F-KIT-1) with polycarbonate lens
Shape: rectangular
Clock Lens: 0.16" clear polycarbonate
Mounting: flush



Division 27 | Communications

Clocks

Installation Notes

It is recommended to specify recessed wall clocks with polycarbonate lenses.



Primex Wireless

www.primexwireless.com

2.5" Six-Digit Flush-Mount Digital Clock

Required Options: Flush-Mount

Polycarbonate Guard

Shape: rectangular

Clock Lens: acrylic

Mounting: flush



Division 28 | Electronic Safety & Security

Fire Alarm Components, General



General Notes

At this time, NYS-OMH is not aware of any patient-safe fire alarm components.

Device covers are susceptible to abuse and can be looped/weaponized. Careful consideration is required when specifying and locating devices associated with fire alarm and other electronic safety and security systems. It is therefore extremely important to locate these items in such a way to prevent patient access and interaction in high and medium risk areas.

Fire alarm notification devices are required to be ceiling mounted in high risk areas.

It is recommended that fire alarm notification devices be ceiling mounted in medium risk areas.