









# Streamlav Wing

SLW01

## Single User Lavatory System

 <p>30" to 60" x 20" x 13 3/4"</p>	 <p>0.35 gpm</p>	  <p>IAPMO Z124-2011/CSA B45.5-11 IAPMO IGC156 ASME A112.18.2-2011/CSA B125.2-11</p>	 <p>Drain: 1 1/2" Supplies: 1/2" Inlet Pressure: 20 to 100 psi</p>	 <p><b>Compliance:</b> ADA TAS Alberta Building Code Ontario Barrier Free (A-Models only) BC Building Code (A-Models only) Code de Construction Québec (Seulement Modèles A)</p>
---	---	--	---	---

### Material & Construction

The innovative bowl is made from anti-microbial solid surface. Solid surface is a composite material of acrylic polyester polymer resins and aluminum trihydrate fillers. The material is resistant to stains and burns and complies with ANSI Z124.3. Solid surface cleans easily with Scotchbrite®, household cleaners or fine grit sandpaper. Solid surface is available in 25 colors.

The Streamlav Wing includes heavy gauge steel powder coated support brackets.

The Streamlav Wing is supplied with one stainless steel strainer (and optional overflow) per bowl. The fixture is supplied with a brass p-trap. If faucets are supplied it comes with a PEX supply manifold.

### Anti-microbial

The Streamlav Wing bowl is manufactured with an anti-microbial agent. The agent is present both on the surface and on the inside of the material and will not dissipate or scratch off. In contact with moisture, anti-microbial ions will be released and effectively kill bacteria.

### Standard Equipment

Countertop in anti-bacterial solid surface material, steel mounting bracket, tail piece & stainless strainer (Model -A)

### Optional Equipment

The Streamlav Wing can be supplied with a stainless steel skirt assembly (Model -B).

The Streamlav Wing can be supplied with any of AquaDesign's faucets or can be drilled for faucets by others.

When choosing faucets by others try to minimize splashing by choosing faucets that are less than 4.5" in height (base faucet to aerator bottom). Aerators with a spray pattern are preferably 0.38 GPM or less, laminar or aerated aerators are preferably 0.5 GPM or less.

### Configurations

The Streamlav Wing can be supplied with custom length side wings. The length of either the left or right side wing can vary between 0" and 15" (with 1" increments).

As an alternate the Streamlav wing can be supplied with rounded corners.

### LEED Compliance

The Streamlav Wing® contributes to meeting LEED requirements in the following categories:

- WEp1 - Water Efficiency
- WEc3 - Water Use Reduction



AquaDesign's faucets have a standard water usage of 0.35 gpm.

### Application



The Streamlav Wing is intended for handwashing only. It is not to be used to dispense water for human consumption either by drinking or use in the preparation of food or beverages.

### Warranty

Warranty: 5 years limited warranty on material and 1 year limited warranty on components.

### SAMPLE SPECIFICATION

Fixture shall be AquaDesign Streamlav Wing single user hand wash station. Countertop is made from anti-microbial solid surface. The unit will have a solid surface drain cover/stainless steel skirt and will have no/an overflow. The unit will be xx (30" to 60") long.

The unit is furnished with a Line6/Line7/Line8/Line9 faucet.



**WARNING:** Cancer and Reproductive Harm  
[www.P65Warnings.ca.gov](http://www.P65Warnings.ca.gov)

Top Views

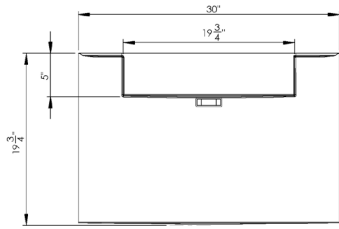

SLW01-L00R00

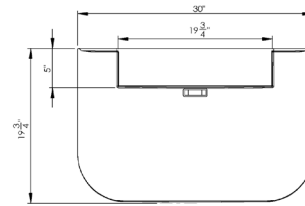

SLW01-L00R00-RD

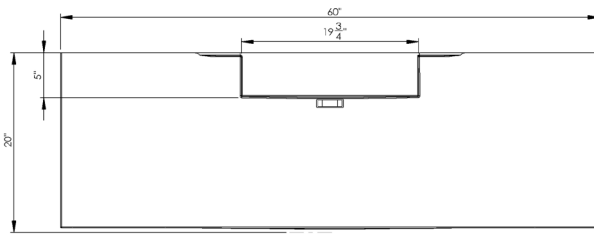

SLW01-L15R15

Front View

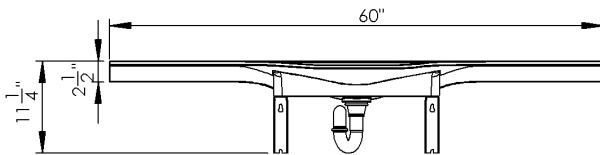

Model -A

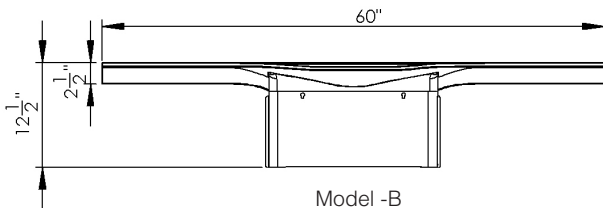

Model -B

Side View Standard Height

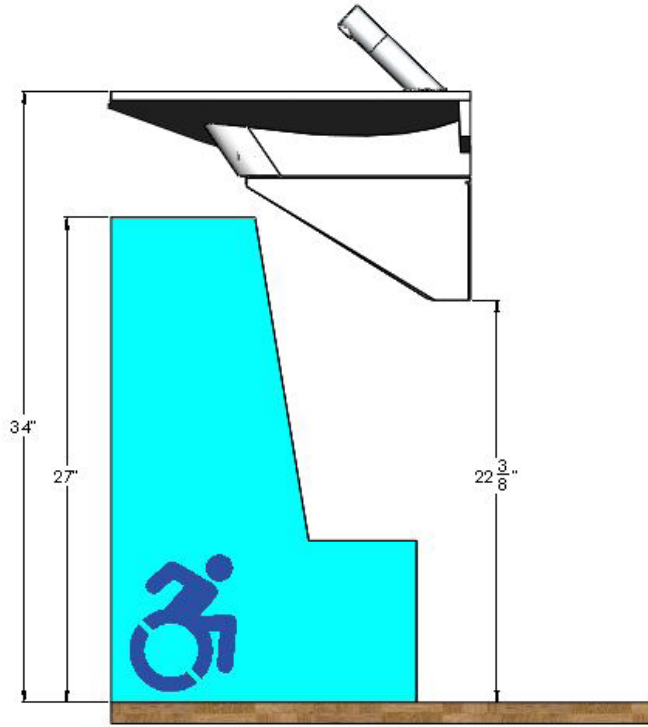

Model -A

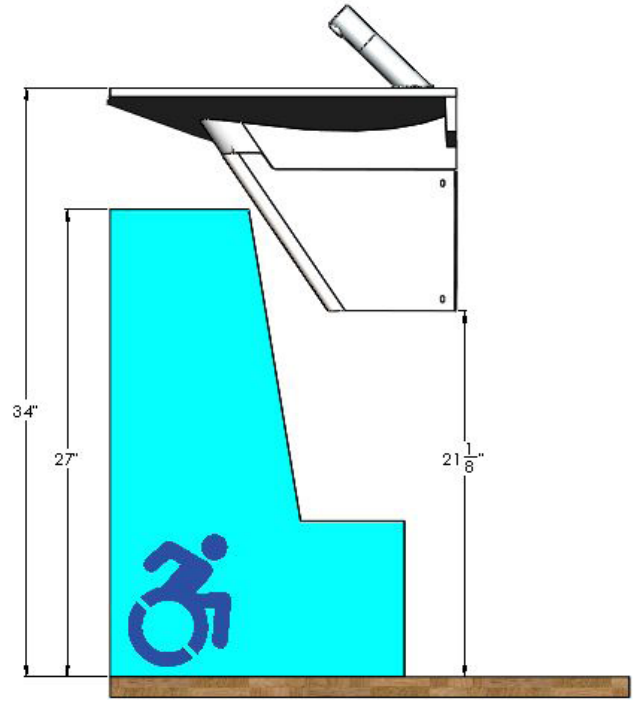

Model -B

### Rough-In Dimensions - Model A

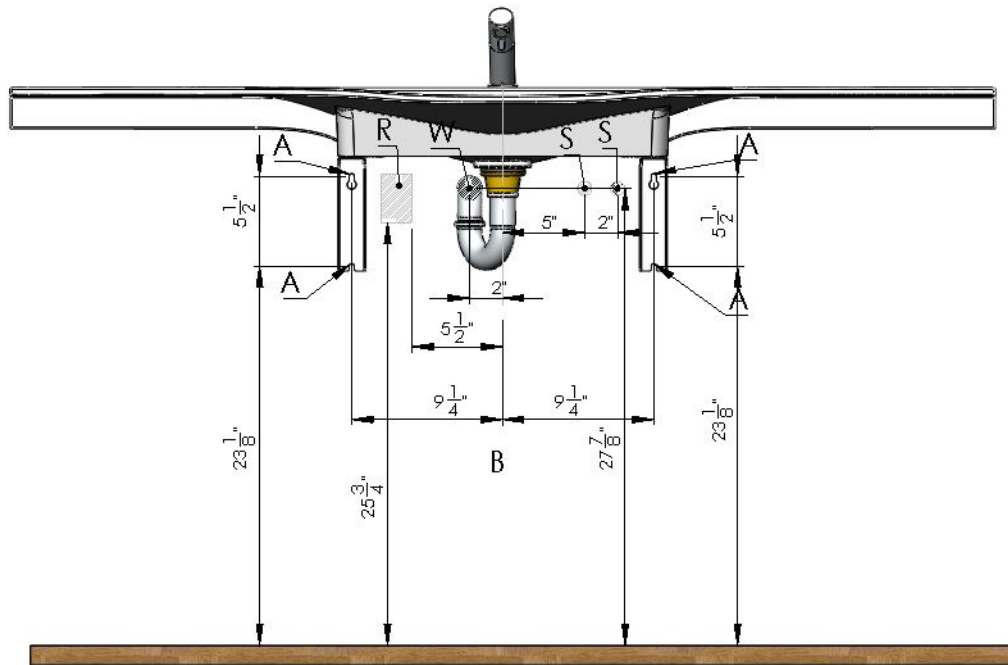

Code	Description
A	3/8" Anchors
R	110V GFCI Outlet
W	1-1/2" NPT Drain
S	1/2" Supply (hot and cold)

**Notes:**

1. Electrical receptacle must be wired to a GFCI protected circuit. Fixture must be earth grounded.
2. Consult local electrical code for need and use of extra electrical conduit box.

### Height Adjustments

Standard	Rim Height	Adjustment of A, B & W
ADA & TAS Adult	34"	None
ADA Juvenile, Age 6-12	31"	Subtract 3" from height in drawing
TAS, Grades 6 through 8 or 9	32"	Subtract 2" from height in drawing
TAS, Grades Pre-K through Grades 5 or 6	30"	Subtract 4" from height in drawing

### Rough-In Dimensions - Model B

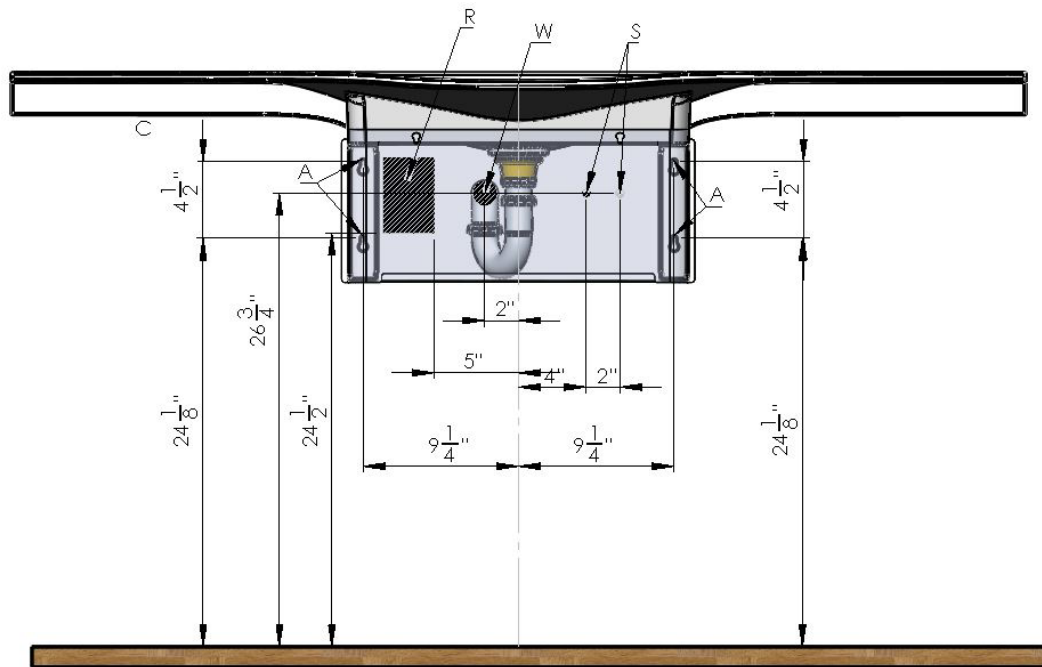

Code	Description
A	3/8" Anchors
R	110V GFCI Outlet
W	1-1/2" NPT Drain
S	1/2" Supply (hot and cold)

**Notes:**

1. Electrical receptacle must be wired to a GFCI protected circuit. Fixture must be earth grounded.
2. Consult local electrical code for need and use of extra electrical conduit box.

### Height Adjustments

Standard	Rim Height	Adjustment of A, B & W
ADA & TAS Adult	34"	None
ADA Juvenile, Age 6-12	31"	Subtract 3" from height in drawing
TAS, Grades 6 through 8 or 9	32"	Subtract 2" from height in drawing
TAS, Grades Pre-K through Grades 5 or 6	30"	Subtract 4" from height in drawing

## How to Choose Your Custom Length?

The standard length of the Streamlav Wing is 30". This is the L00R00-model.



The length of the Wing can be increased with 15" on each side. The length you wish to add to the left and right side of the lavatory will define the values for Lxx and Rxx.

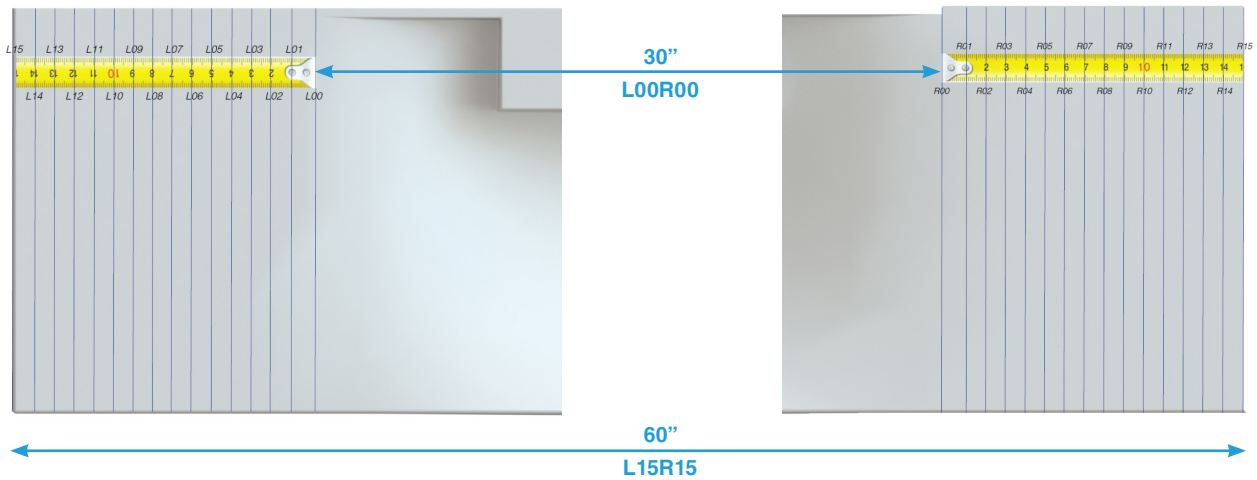

<b>001</b>	<b>Base Model Number</b> (must specify)
<input type="checkbox"/>	SLW01 Single User Streamlav Wing Lavatory System
<b>002</b>	<b>Length of Lavatory</b> (must specify)
<input type="checkbox"/>	-L <input type="checkbox"/> <input type="checkbox"/> Length to be added on Left Side
<input type="checkbox"/>	-R <input type="checkbox"/> <input type="checkbox"/> Length to be added on Right Side
<b>003</b>	<b>Skirt</b> (must specify)
<input type="checkbox"/>	-A No Skirt
<input type="checkbox"/>	-B Stainless Steel Skirt
<b>004</b>	<b>Operation</b> (must specify)
<input type="checkbox"/>	-L06 Line 6 Faucets
<input type="checkbox"/>	-L07 Line 7 Faucets
<input type="checkbox"/>	-L08 Line 8 Faucets
<input type="checkbox"/>	-L09 Line 9 Faucets
<input type="checkbox"/>	-DEK No Faucets
<b>005</b>	<b>Supply</b> (must specify with faucets)
<input type="checkbox"/>	-TEM Tempered or Cold Water
<input type="checkbox"/>	-TMV Thermostatic Mixing Valve
<b>006</b>	<b>Color</b> (must specify)
	<u>Standard Colors</u>
<input type="checkbox"/>	-AB Adobe Brown
<input type="checkbox"/>	-AW Ash White
<input type="checkbox"/>	-CG Country Green
<input type="checkbox"/>	-CO Concrete grey
<input type="checkbox"/>	-DB Designer Black
<input type="checkbox"/>	-ES Egyptian Sand
<input type="checkbox"/>	-MB Midnight Blue
<input type="checkbox"/>	-MG Misty Grey
<input type="checkbox"/>	-PB Pearl Black
<input type="checkbox"/>	-PW Polar White
<input type="checkbox"/>	-SA Sandstone
<input type="checkbox"/>	-TG Twilight Grey
	<u>Designer Colors</u>
<input type="checkbox"/>	-AC Amalfi Coast
<input type="checkbox"/>	-BB Belgian Blue
<input type="checkbox"/>	-BF Black Forrest
<input type="checkbox"/>	-CA Carrara Grey
<input type="checkbox"/>	-CC Cebolla Creek
<input type="checkbox"/>	-CP Caledonia Pearl
<input type="checkbox"/>	-PC Portofina Crema
<input type="checkbox"/>	-PS Paris Stone
<input type="checkbox"/>	-RS San Cristobal Silver
<input type="checkbox"/>	-SR Sydney Rock Oyster
<input type="checkbox"/>	-UB Ubatuba Brown
<input type="checkbox"/>	-VM Vienna Mist
<b>007</b>	<b>Soap Options</b> (for Models Without Skirt Only)
<input type="checkbox"/>	-SD7 Line 7 Soap Dispenser
<input type="checkbox"/>	-SD8 Line 8 Soap Dispenser
<input type="checkbox"/>	-SD9 Line 9 Soap Dispenser
<b>008</b>	<b>Other Options</b>
<input type="checkbox"/>	-HW Low Voltage Class II Plug-In Transformer
<input type="checkbox"/>	-RD Rounded Corners
<input type="checkbox"/>	-TCRL Round Opening For Trash On Left Wing
<input type="checkbox"/>	-TCRR Round Opening For Trash On Right Wing
<input type="checkbox"/>	-TCSL Square Opening For Trash On Left Wing
<input type="checkbox"/>	-TCSR Square Opening For Trash On Right Wing

**Approved by:**

Name: \_\_\_\_\_

Title: \_\_\_\_\_

Signature: \_\_\_\_\_

All information including dimensions, changes in design and material are subject to manufacturer's change without formal notice and without obligation. AquaDesign assumes no responsibility for use of superseded or voided information. Verify all rough-in information before installation. It is the responsibility of the installer to conform with local and national codes.