

INSTALLATION INSTRUCTIONS

MOD50 - Two User Modus

MODELS: MOD50-A
MOD50-B

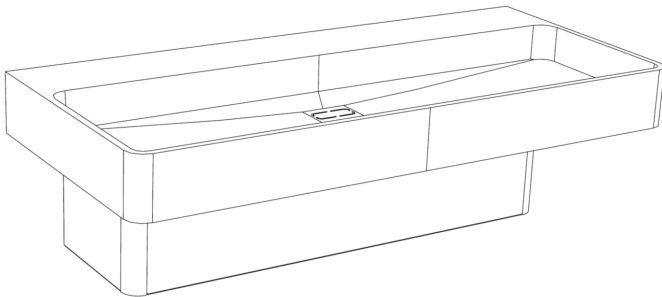
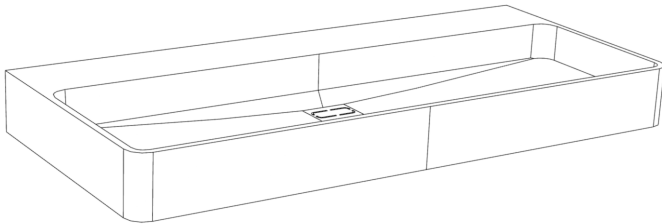

IMPORTANT

- Read the entire instructions entirely prior to installation.
- Prior to connecting the fixture to the water supply make sure that all the lines are flushed thoroughly. Debris in the lines can cause valves to malfunction and voids the warranty.
- All wall anchors should have a pull out strength of 1000 lbs or more. Choose the appropriate hardware and backing material for the type of wall on the premises.
- Units should always be installed according to local plumbing and/or electrical codes.
- Turn off all electrical power to the outlets in the vicinity of the lavatory system you're about to install. Power must remain off until installation is complete.

Installation Instructions

Top View

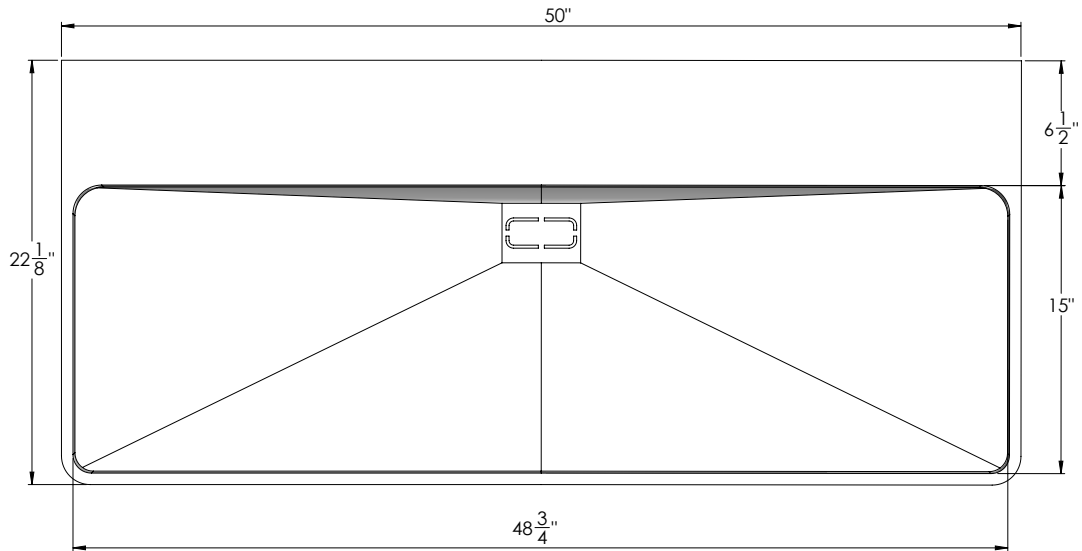

Front View

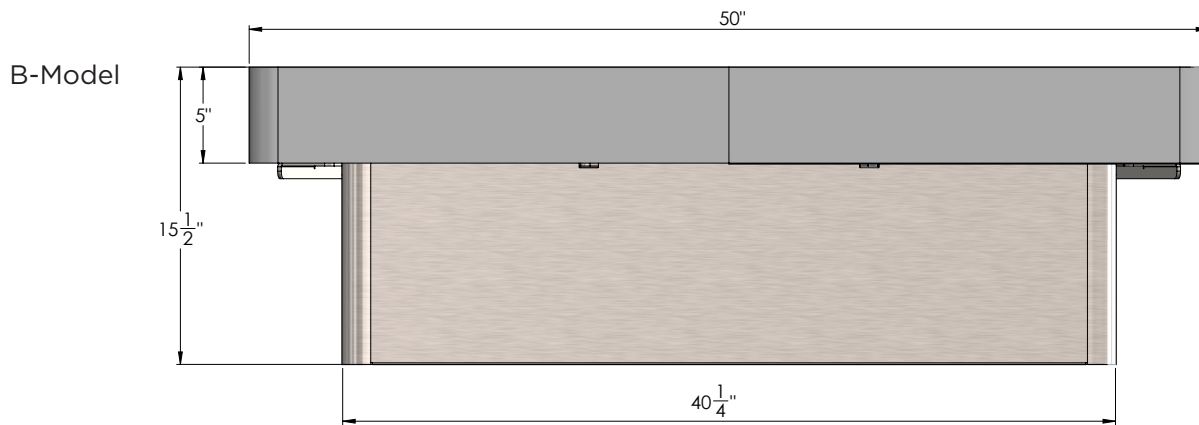
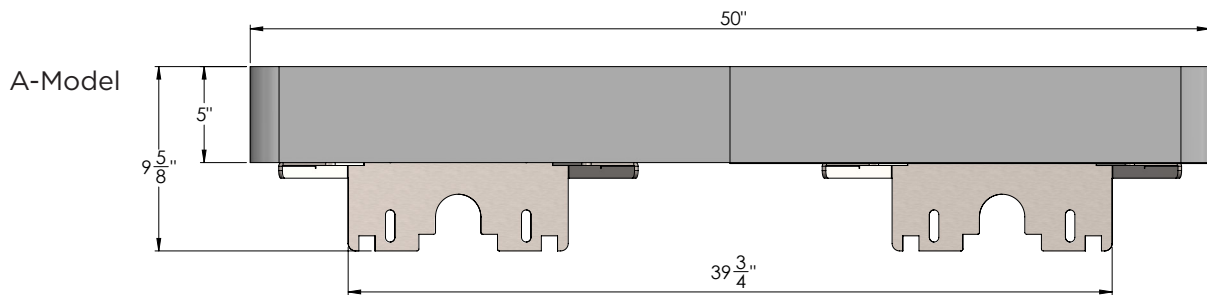

Installation Instructions

Side View

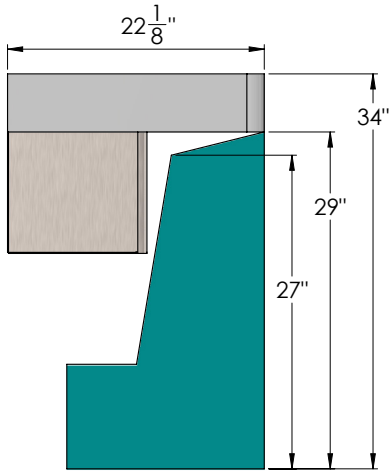

ADA, TAS
All Models

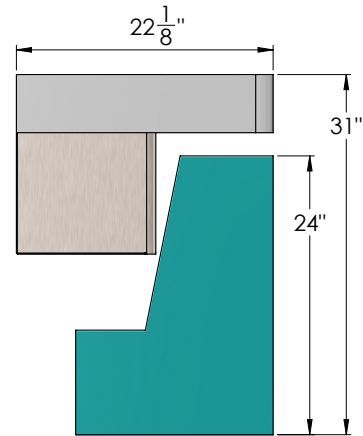

ADA - Juvenile Height
All Models

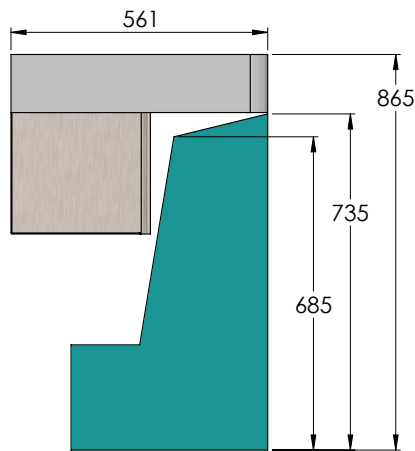

Alberta, BC, Québec
All Models

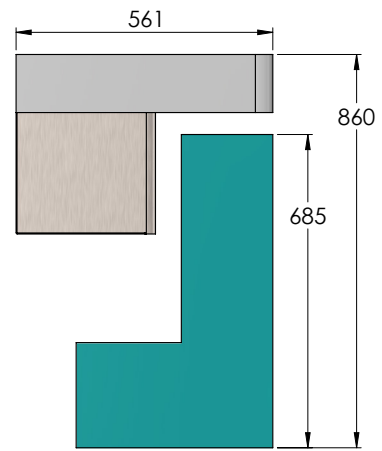

CSA/ASC B651:23
All Models

Installation Instructions

Rough-In Dimensions MOD50

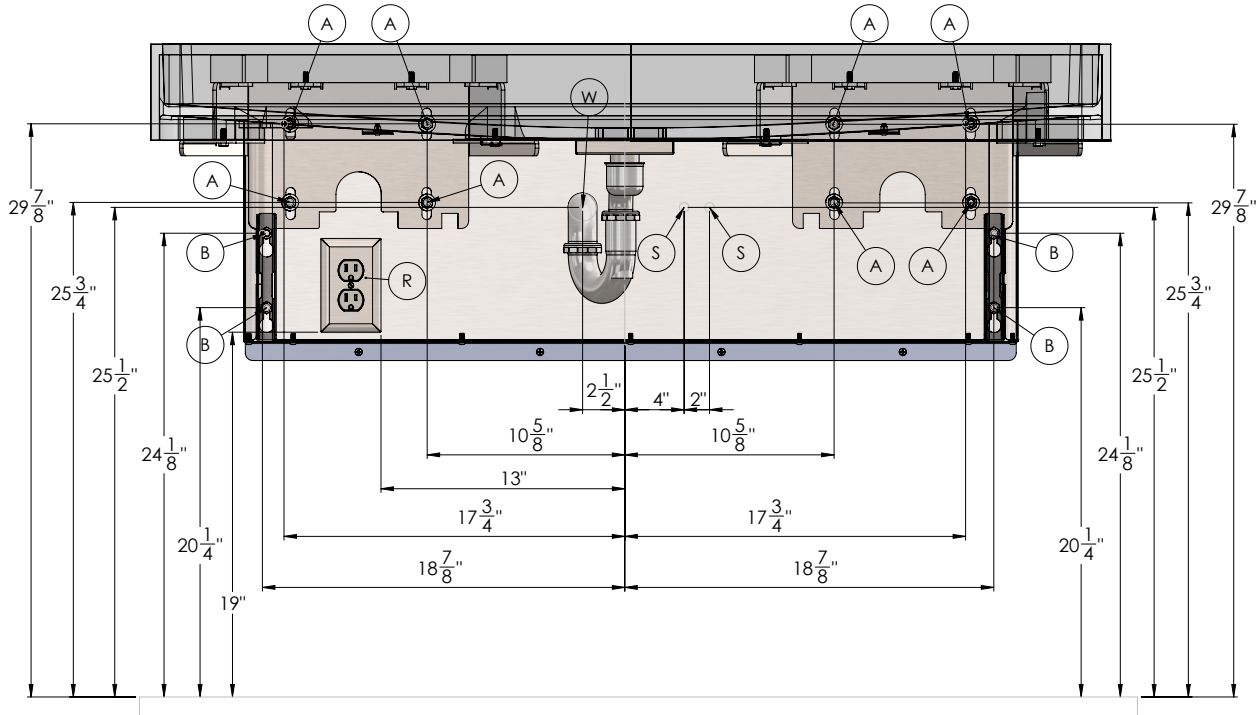

* All vertical measurements are measured from the FINISHED floor

Code	Description
A	3/8" Anchors for support brackets with a pull out strength of min. 1000 lbs.
B	ONLY FOR B MODELS - 1/4" Anchors for skirt brackets
W	1-1/4" NPT Drain, stub out 2"
S	1/2" copper tubing for hot & cold supplies, stub out 2"
R	110V GFCI Outlet

Height Adjustments

Standard	Rim Height	Adjustment of height for A, B, W, S & R
ADA & TAS Adult	34"	None
ADA Juvenile, Ages 6-12	31"	Subtract 3" to height in drawing

Step 1: Rough-In

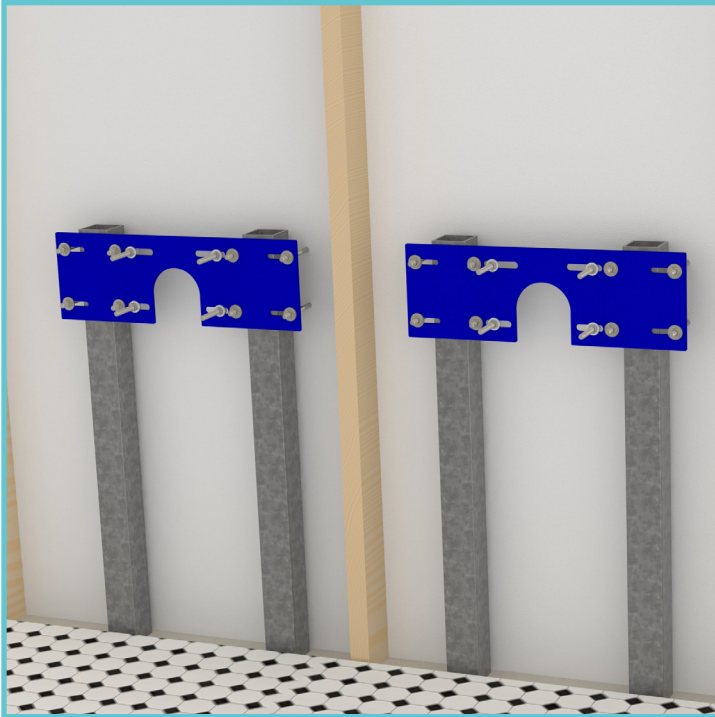

When using the AquaDesign carrier plate:

- Install the plate on the fixture support studs according to the carrier plate instructions.
- Hardware and fixture support studs are supplied by others
- Rough in the ½” copper supply tubing through the wall at the locations marked with **S** on the rough-in drawing on page 4 or 5.
- Rough in the 1-1/4” drain connection through the wall at the location marked with **W** on the drawing on page 4 or 5.
- When using faucets with plug-in transformer(s): rough-in the GFCI electrical outlet at the location marked with **R** on the drawing on page 4 or 5.
- Install four 1/4” anchors on the locations marked with **A** on the drawing on page 4 or 5.
- The anchors should have a pull-out strength



Using a backer plate in the wall:

- In the event you are not using AquaDesign’s carrier plate, we recommend you use a plywood board of sufficient thickness (5/8” or more). It is important that the plywood is attached to 2 or more studs.
- Anchor the plywood to the studs in the wall. It is recommended to anchor it at least one stud to the left and right of the fixture.
- Rough in the ½” copper supply tubing through the wall at the locations marked with **S** on the rough-in drawing on page 4 or 5.
- Rough in the 1-1/4” drain connection through the wall at the location marked with **W** on the drawing on page 4 or 5.
- When using faucets with plug-in transformer(s): rough-in the GFCI electrical outlet at the location marked with **R** on the drawing on page 4 or 5.

Installation Instructions

Step 2: Hang the Lavatory

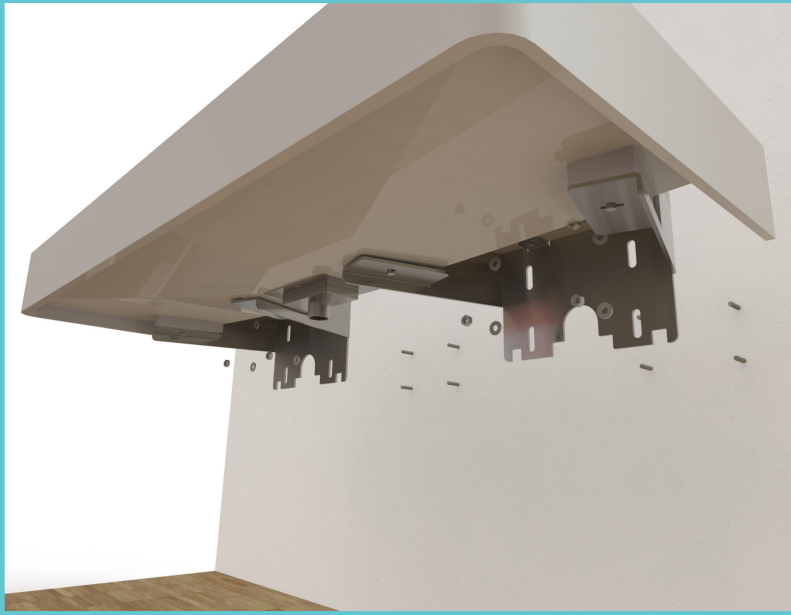

Installation Instructions

Step 3: Install the P-trap and Supplies

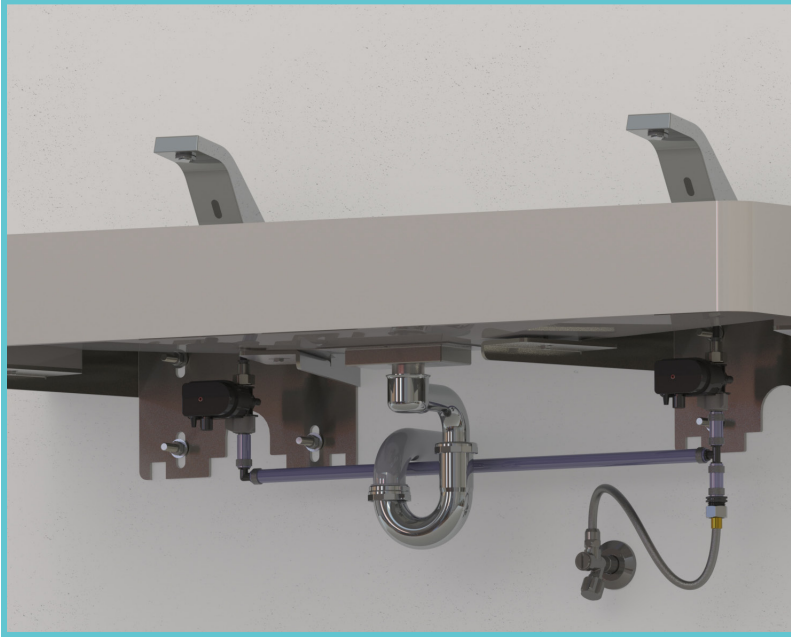

Installation Instructions

Step 4: Installing the Skirt (B-Models Only)

4.1 Mount the Skirt Brackets

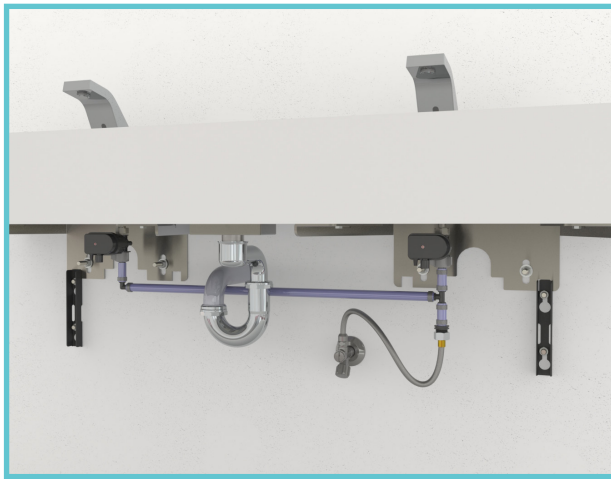

4.2 Install Skirt under the Skirt Brackets

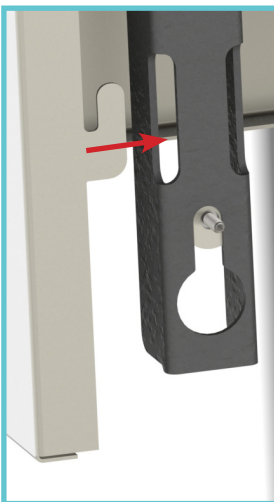

Installation Instructions

4.3 Attach Skirt to Underside Bowl

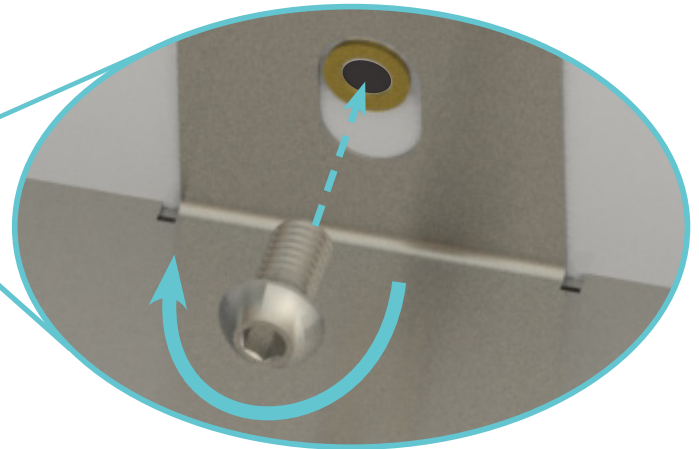
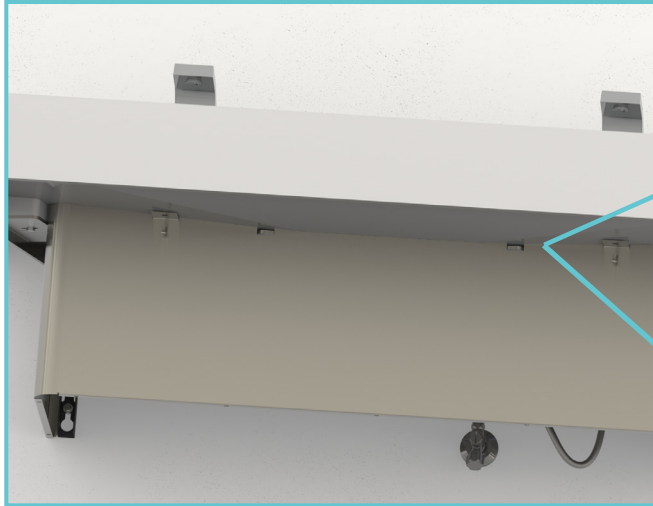

Installation Instructions

MAINTENANCE

Solid Surface Bowl

AquaDesign's solid surface material is made of acrylic modified polyester resins, aluminum trihydrate fillers and color granules. This synthetic compound material has an elegant granite-like appearance. It is not only virtually indestructible and easy to maintain, but equally matches perfectly from an aesthetic viewpoint, this resulting in a remarkable design with soft, rounded shapes, ideal for the public washroom.

- Daily care: wipe the surface with soapy water or a damp cloth.
- Surface staining: clean the surface with soapy water or ammonia based cleansers.
- Stubborn stains and superficial scratches: clean the surface with an abrasive cleanser and a wet sponge. You can also use a green Scotch Brite® pad.
- Stubborn scratches: sand with 400 grit sandpaper and then clean with an abrasive cleanser and a green Scotch Brite® pad.
- AVOID contact with harsh chemicals such as drain cleansers and paint removers.
- AVOID contact with hot pots or heat producing appliances.

Stainless steel panels

Things to Avoid

- AVOID scouring a Stainless steel surface across the satin finish lines. Scouring across the satin finish lines can damage the original Stainless steel grain finish. Never use an abrasive scouring pad.
- Don't allow liquid soap or other household cleansers to dry on the Stainless steel surface. Most brands contain chemical additives, which will affect the finish.
- Never leave solutions of chlorine bleach and water on your Stainless steel surface for extended periods of time. Chlorides, which are found in most soaps, detergents, bleaches, and cleansers, are very aggressive to stainless steel. If left on too long they can cause surface pitting.
- Don't use a steel wool pad to clean your Stainless steel. Steel wool pads have a tendency to break apart and small particles of steel can become embedded in the surface of the sink. The steel particles will rust and will give the appearance that the Stainless steel itself is rusting.
- Never leave wet sponges, cloths, or cleaning pads on the Stainless steel surface. This can lead to surface rust.

Things to Do

- Rinse or clean surface after use. Clean with warm, soapy water.
- Avoid caustic chemicals. Avoid exposing your appliance to strong chemicals, such as paint removers, oven cleaners, etc. If contact occurs, quickly flush the surface with water.
- Follow the grain. When cleaning the Stainless steel surface of your sink, be sure to rub in the direction of the grain finish lines.