

Solidwave High-Low

-BCL/-BCR

Baby Changer - Hand Wash Station

Dimensions	Water Use	Certifications	Technical	Barrier Free
42" x 22" x 6 ^{1/8} "	0.5 gpm	 IAPMO Z124-2011 CSA B45.5-11 IAPMO IGC156 ASME A112.18.2-2011 CSA B125.2-11	Drain: 1 1/2" Supplies: 1/2" IPS Inlet Pressure: 20-100 psi	ADA TAS Alberta Building Code Code Construction Québec

Material & Construction

The bowl of the sink and the baby changing table surface are made from solid surface. Solid surface is a composite material of acrylic polyester polymer resins and aluminum trihydrate fillers. The material is resistant to stains and burns and complies with ANSI Z124.3. Solid surface cleans easily with Scotchbrite®, household cleaners or fine grit sandpaper. Solid surface is available in 15 colors.

The combo includes heavy gauge stainless steel support brackets. The Solidwave High-Low is supplied with one chromed 1 1/4" brass grid strainer and overflow per bowl.

Optional Anti-microbial

The Solidwave High-Low bowl can be manufactured with an anti-microbial agent. The agent is present both on the surface and on the inside of the material and will not dissipate or scratch off. In contact with moisture, anti-microbial ions will be released and effectively kill bacteria.

Standard Equipment

Countertop and baby changing table in anti-bacterial solid surface material, steel mounting bracket, stainless steel skirt, tail piece, safety strap, two purse hooks and warning sticker..

Configurations

The baby changing table option can be attached to most Solidwave High-Low lavatory systems (NOT to the SWV3L). The baby changing table can only be attached to the high side of the Solidwave High-Low lavatory system.

LEED Compliance

The Solidwave High-Low contributes to meeting LEED requirements in the following categories:

- WEp1 - Water Efficiency
- WEc3 - Water Use Reduction

AquaDesign's faucets have a standard water usage of 0.5 gpm.

Application

The Solidwave High-Low is intended for handwashing only. It is not to be used to dispense water for human consumption either by drinking or use in the preparation of food or beverages.

Warranty



Warranty: 5 years limited warranty on material and 1 year limited warranty on components.

SAMPLE SPECIFICATION

Fixture shall include an integral baby changing table with safety strap. The baby changing table shall be 42" by 22" and include two integral hooks. The baby changing table shall be made of anti-microbial solid surface



Can only be ordered in combination with a Solidwave High-Low Lavatory System

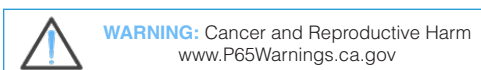

001	Base Model Number (must specify)	
	<input type="checkbox"/> -BCL	Baby Changer on Left Side of Solidwave High Low
	<input type="checkbox"/> -BCR	Baby Changer on Right Side of Solidwave High Low
002	Anti-Microbial Solid Surface	
	<input type="checkbox"/> -AMSS	Anti-Microbial Agent in Countertop

Front View

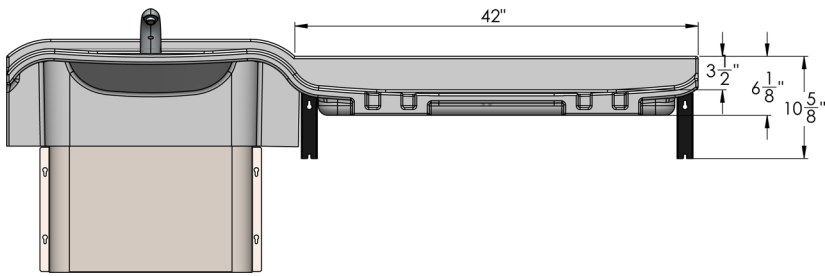

Top View

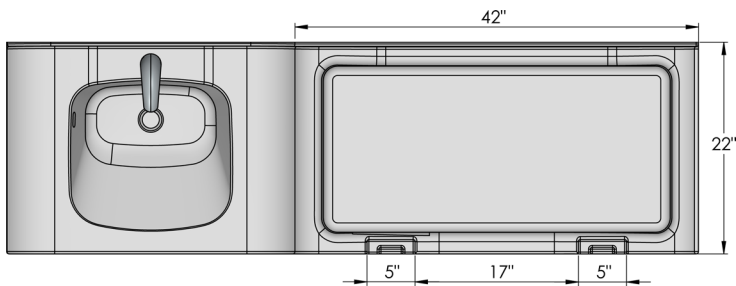

Side View

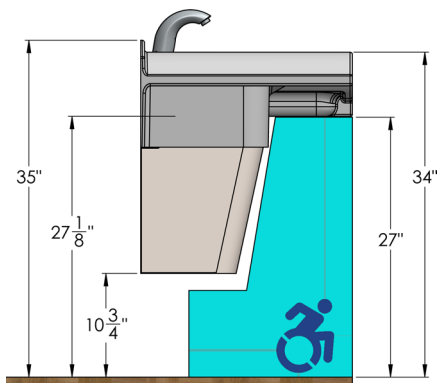

Rough-In Dimensions

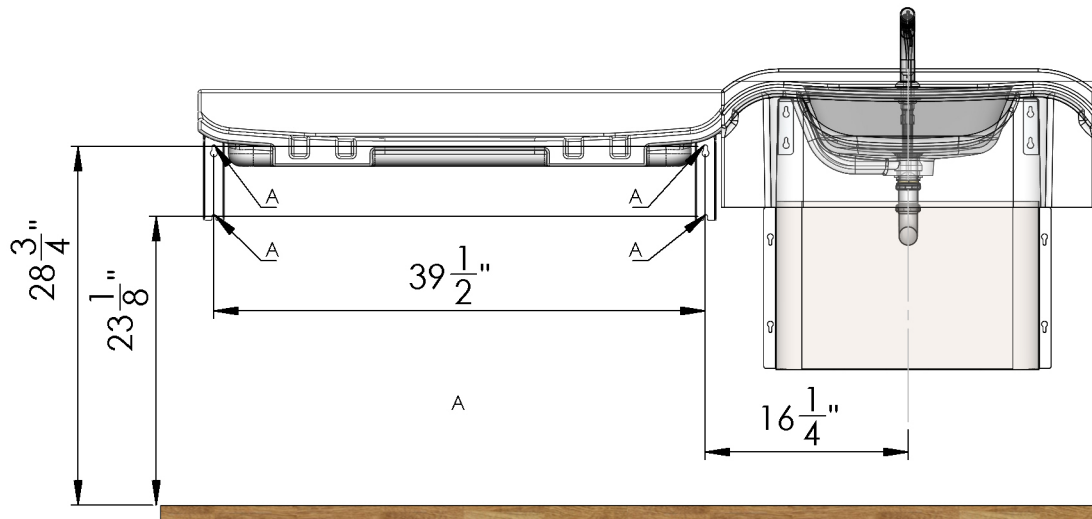

Code	Description
A	1/4" Anchors

 **WARNING:** Be sure to use anchors with a pull out strength of 1000 lbs. Additional reinforced backing behind the wall might be required to properly mount the baby changing station and lavatory system.

 **WARNING:** Every Solidwave High-Low with the baby changing station option is supplied with a warning sticker. It is very important that the sticker is placed right above the baby changing station. Failing to do so might result in serious injury.

 **WARNING**

 **WARNING** Never leave child unattended.

 **WARNING** Avoid serious injury from falling or sliding out. Always use restraint.

 **WARNING** Designed for infants only. Age up to 3.5 years and weighing less than 50 lb. Keep one hand on the child at all times.

Intertan Manufacturing Company - www.intertanUS.com

Height Adjustments

Standard	Rim Height	Adjustment of A, B, R & W
ADA & TAS Adult	34"	None