

November 2019

Edition 9.0



BEHAVIORAL HEALTH DESIGN GUIDE

Formerly:
Design Guide for the Built Environment
of Behavioral Health Facilities

James M. Hunt, AIA
David M. Sine, DrBE, CSP, ARM, CPHRM
Kimberly N. McMurray, AIA, EDAC, MBA

***Includes REVISED
Safety Risk Assessment Tool
to align with The Joint Commission's
Recommendations***

Behavioral Health Facility Consulting, LLC

Previously Published by:
National Association of Psychiatric Health Systems (NAPHS) 2003-2014
Facility Guidelines Institute (FGI) 2015-2017

Contents

Introduction	4
A Word from the Authors.	5
Resources.	6
More Information on Specific Topics	7
Glossary	7
A Word from BHFC	8
General Comments.	9
A. Space Planning Considerations	9
B. Safety	11
Construction and Materials Considerations	14
A. Baseline considerations for patient areas.	14
B. Level I.	41
C. Level II	42
D. Level III.	47
E. Level IV.	50
Level IV-a. Patient Rooms	50
Level IV-b. En-suite Patient Toilet Rooms:	59
F. Level V:	69
Level V-a. Admissions:	69
Level V-b. Seclusion Rooms and Restraint Rooms	72
Summary	77
Appendix Index.	78
About the Authors	157
List of Manufacturers	158

Behavioral Health Design Guide

Edition 9.0

November, 2019

© 2019 Behavioral Health Facility Consulting, LLC

In an effort to keep up with the rapid increase in the number of products available for use in behavioral health facilities, this document will be updated frequently. The date of each edition is on the cover and at the top of each page of the document.

Readers are urged to check: www.bhfcllc.com whenever referring to this document to assure the latest information is being accessed.

Edition 9.0

This edition has been extensively reorganized and edited since the last edition. The major difference is the inclusion of the Baseline Considerations section which starts on page 14. This is intended to simplify and clarify the differences between the various Levels of Risk introduced in the Safety section starting on page 11. The Section for each risk level now only addresses how that Level differs from the Baseline Considerations.

For convenience for those who are accessing this electronically, The Table of Contents and Appendix Index items are linked so that clicking on an item will take the reader to the selected item.

Due to the extent of this reorganization, the text that has been revised since the last edition is not shown in blue, as has been our practice in the past.

Introduction

This document is intended to address the built environment of the general adult inpatient behavioral health care unit. Additional considerations that are not addressed here are required for child and adolescent patients, patients with medical care needs, dementia patients, and some patients with diagnoses such as substance abuse and eating disorders.

This document is not a replacement for regulatory requirements, but rather augments them to detail practical means of protecting patients and staff. It is intended to represent leading current practices, in the opinion of the authors. It is not intended to represent minimum acceptable conditions and should not be interpreted as establishing a legal “standard of care” that facilities are required to follow.

Please Note

Product information included in this document is intended for illustration of one or more specific items that are deemed appropriate for use in this type of facility. Comparable products by other manufacturers that meet the same design criteria may be substituted after careful comparison.

This document is intended to represent leading current practices, in the opinion of the authors. It does not represent minimum acceptable conditions or establish a legal “standard of care” that facilities are required to follow.

A Word from the Authors

This Design Guide continues to be co-authored by James M. Hunt, AIA, Founder and Senior Consultant of Behavioral Health Facility Consulting, and David M. Sine, DrBE, ARM, CSP, CPHRM, president of SafetyLogic Systems. As the Design Guide continues to evolve, we are pleased to be joined by Kimberly N. McMurray, AIA, EDAC, MBA who is the Principal of Behavioral Health Facility Consulting, LLC. She brings an architectural career dedicated to healthcare design, including a period of being on staff at a major academic medical center. She is currently immersed in the daily contact with organizations and designers engaged in the process of navigating through today's complex behavioral health environments.

It is based on our experiences in the field as operators, designers, consultants, and surveyors. Our goal is to share what we have seen that is working and what we have seen that has not worked. Since the document was first electronically published by the National Association of Psychiatric Health Systems (NAPHS) in 2003 we have received and welcomed countless suggestions, recommendations, and comments from users of the Design Guide, which continue to inform and lead us to new discoveries. We are grateful and humbled by how well our suggestions have been received and that they have inspired others to think of new solutions to the inherent challenges of the behavioral health, built environment.

We hope this edition of the Behavioral Health Design Guide (formerly the Design Guide for the Built Environment of Behavioral Health Facilities) will meet the expectations of and prove useful to the operators, clinicians and designers who are entrusted with both the care of behavioral health patients and with the environment of care in which those people are cared for and treated.

As always, we introduce this edition with the same reminder we used to introduce the inaugural edition in 2003: "While a safe environment is critical, no environment of care can be totally safe and free of risk. No built environment—no matter how well designed and constructed—can be relied upon as an absolute preventive measure. Staff awareness of their environment, the latent risks of that environment, and the behavioral characteristics and needs of the patients served in that environment are absolute necessities. We also know that different organizations and different patient populations will require greater or lesser tolerance for risk; an environment for one patient population will not be appropriate for another. Each organization should continually visit and revisit their tolerance for risk and changes in the dynamics of the patient population served."

As in earlier editions, we have highlighted products we have found to be more safe and able to withstand the rigors of use in the behavioral health care environment. However, inclusion or exclusion of a product does not indicate endorsement or disapproval of that product, nor does it suggest that any product we identify is free of risk. As well, there may be equivalent products available; all facilities should continually look to the marketplace to find products that are safer and more cost-effective.

James M. Hunt, AIA jim@bhfcllc.com

David M. Sine, DrBE, CSP, ARM, CPHRM dsine9@gmail.com

Kimberly N. McMurray, AIA, EDAC, MBA kimberly@bhfcllc.com

This document is intended to represent leading current practices, in the opinion of the authors. It does not represent minimum acceptable conditions or establish a legal "standard of care" that facilities are required to follow.

Resources

ADA - Americans with Disabilities Act. The Americans with Disabilities Act gives civil rights protections to individuals with disabilities similar to those provided to individuals on the basis of race, color, sex, national origin, age, and religion. It guarantees equal opportunity for individuals with disabilities in public accommodations, employment, transportation, state and local government services, and telecommunications. See www.ada.gov.

CMS - Centers for Medicare & Medicaid Services. CMS is part of the U.S. Department of Health and Human Services and is responsible for the administration of the Medicare and Medicaid programs. They are currently finalizing their proposed “Clarification of Ligature Risk Interpretive Guidelines”. Text of the draft is available [on their website](#) and at www.bhfcllc.com.

FGI Guidelines - FGI Guidelines for Design and Construction of Hospitals. Published by the Facility Guidelines Institute and is adopted as law by some states and used by some courts as establishing a Standard of Care. Verify edition that may be adopted at any specific location with local AHJ. The authors recommend complying with the latest published edition for all projects. This volume includes chapters on free-standing psychiatric hospitals and psychiatric units in general hospitals. Other volumes are available for Outpatient Facilities and Residential Health Care and Support Facilities. For information on purchasing the FGI Guidelines, visit www.fgiguidelines.org.

HIPAA - Health Insurance Portability and Accountability Act, 1996. The Office for Civil Rights in the U.S. Department of Health and Human Services (HHS) enforces the HIPAA Privacy Rule, which protects the privacy of individually identifiable health information; the HIPAA Security Rule, which sets national standards for the security of electronic protected health information; and the confidentiality provisions of the Patient Safety Rule, which protect identifiable information being used to analyze patient safety events and improve patient safety. See www.hhs.gov/ocr/privacy.

IAHSS - International Association for Healthcare Security and Safety
See www.iahss.org

NFPA - National Fire Protection Association. They publish the NFPA 101: Life Safety Code®, [available here](#). For more on NFPA or links to new publications, see www.nfpa.org.

NIC - National Institute of Corrections. See www.nicic.gov.

TJC - The Joint Commission. There is now free access to a Suicide Prevention Portal on [TJC's website](#). This contains the recommendations of TJC's Expert Panel on Suicide Prevention, related National Patient Safety Goals discussion regarding tools for evaluating the suicidal intention of patients. This is kept updated with the latest information and is available to all without a subscription fee.

This document is intended to represent leading current practices, in the opinion of the authors. It does not represent minimum acceptable conditions or establish a legal “standard of care” that facilities are required to follow.

More Information on Specific Topics

- **GLAZING: Syroka & Associates, Inc.**

Bob Syroka, CSI - President (www.syrokaandassociates.com)

- **HOSPITAL SECURITY: Healthcare Security Consultants, Inc.**

Thomas A. Smith, CHPA, CPP - President (www.healthcaresecurityconsultants.com)

Glossary

- **Ligature-Resistant:** TJC, in its November 2017 Edition of its *Perspectives* newsletter recommends the term “Ligature-Resistant” over “Ligature-Free” because it is not possible to remove all potential ligature risk points that could be used in a suicide attempt. It defines Ligature-Resistant as, “***Without points where a cord, rope, bedsheet, or other fabric/material can be looped or tied to create a substantial point of attachment that may result in self-harm or loss of life.***”
- **Tamper-Resistant:** For the purposes of this document, the authors use the term “tamper-resistant” to refer to items that are difficult for patients to remove or damage using items to which they typically have access.
- **Safety Risk Assessment:** The *FGI Guidelines for the Design and Construction of Hospitals* (2018 Edition) **Section 1.2-4 Safety Risk Assessment (SRA)** requires that such an assessment, including **Section 1.2-4.6 Behavioral and Mental Health Risk (Psychiatric Patient Injury and Suicide Prevention) Assessment** as described therein be performed for all such facilities.

A Word from BHFC

The **Behavioral Health Design Guide** (Design Guide) addresses the built environment for adult inpatient behavioral health care units and the evolving Design Guide was moved from its former home with the Facilities Guidelines Institute or FGI to its present home on the Behavioral Health Facility Consulting, LLC (BHFC) website, www.bhfcllc.com in 2018. We found this move necessary in order to preserve the independence of the Design Guide and, through affiliate relationships, to provide even more organizations and their members access to a document that addresses leading practice design challenges of the built environment for adult inpatient behavioral health care units.

Some of the elements of the Design Guide, such as the Environmental Safety Risk Assessment tool, will continue to appear in the FGI Guidelines for Design and Construction of Hospitals and Outpatient Facilities. This Design Guide provides much more detail and leading practices for protecting patients and staff as identified through the authors' years of practice in the field. The Design Guide is not intended as a replacement for regulatory requirements nor to be employed as a legal "standard of care." Its content is provided to augment the fundamental design requirements for behavioral health facilities and to help providers and design teams develop physical environments that support safe and effective behavioral health services.

As always, we should remind readers that the Design Guide does not discuss the additional concerns that must be addressed when designing behavioral health facilities for child and adolescent patients, patients with medical care needs, geriatric patients, or some patients with diagnoses such as substance abuse and eating disorders.

Information is included about products that have been found to be more safe for use in the behavioral health built environment but is in no way a complete list of products available that may be appropriate, while recognizing that no product is entirely without risk. We should also point out that the editors vigorously resist offers to monetize the Design Guide or be compensated by enthusiastic vendors.

The Design Guide is updated periodically, and while we trust you will find the latest changes helpful, our goal is to provide updates more frequently than has been possible in the past, so please return to these pages occasionally to make sure you are referring to the most current edition.

Thank you for your continued interest in and use of the Behavioral Health Design Guide.

Kimberly N, McMurray, AIA, EDAC, MBA – Principal

James M. Hunt, AIA – Founder and Senior Consultant

General Comments

A. Space Planning Considerations

Behavioral health units and facilities are preferred to be designed to appear comfortable, attractive, relaxing and as residential in character as possible. The focus on patient and staff safety has often pushed the aesthetics of these units toward the appearance of a prison environment. To better meet the needs of patients, the final design must avoid an “institutional look” while meeting the array of applicable codes and regulations and addressing the therapeutic and safety needs of patients and staff. These no longer need to be either-or trade-offs. Both safety and therapeutic environment are possible in a well-designed facility that has a non-institutional appearance that is correct for the unique conditions that exist in each facility.

1. The **FGI Guidelines** Section 1.2-4 requires that a Safety Risk Assessment (SRA) be performed to determine the level of risk that is acceptable for both patients and staff in each part of the patient accessible areas of behavioral health units. The SRA Report is vital and must be consulted in reaching all safety related decisions.
2. Nurse station designs are preferred to provide the least acceptable barrier between staff and patients. This goal may conflict with staff safety concerns as patients may be able to reach or jump over counters. Some facilities have found ways to design nurse stations that protect against these actions without discouraging conversation and exchange of objects between staff and patients (**See photos at right, note fine vertical lines in the Enclosed photo**). When minimal physical barriers are provided, it is often desirable to include a conveniently located lockable door through which staff can retreat when feeling threatened. **HIPAA** privacy regulations can make use of an “open” design challenging because patient records, electronic or otherwise, must be protected from view by other patients, visitors, and unauthorized staff. However, advancements in electronic medical records have somewhat reduced the need to locate all charting-related activities and spaces in the area behind the nurse station. Since the electronic “chart” can be accessed from many locations, the area around the nurse station can often be used for more patient-centered activities. When a more open nurse station is achieved, other areas where clinical staff can discuss patients without being overheard is needed.



OPEN



ENCLOSED

3. Location of gathering areas for patients near the nurse station is encouraged because patients often congregate by the nurse station to socialize. It is far better to plan for this behavior and accommodate it in the original design. Such gathering areas should include comfortable seating and places for conversation, card or board games, and other quiet activities that will not distract staff working in the nurse station. Television sets and other electronic entertainment equipment is not preferred in these locations. Many facilities are now experiencing issues, especially with younger patient populations,

This document is intended to represent leading current practices, in the opinion of the authors. It does not represent minimum acceptable conditions or establish a legal “standard of care” that facilities are required to follow.

regarding use of personal electronic devices (e.g., iPods, MP-3 players, and similar devices). Patients say these electronics help keep them calm, but the wires on the earphones can be hazardous. The decision about how to handle this potential hazard is just one of many decisions that behavioral health organizations need to weigh to determine the level of risk they are willing to accept for the perceived benefit. It should always be remembered that a patient who has been assessed as safe to use a player may set it down where another patient may pick it up to gain access to the wires.

4. Chart rooms and other staff areas should be located so staff members can have conversations and make phone calls regarding patients and other clinical matters without being overheard by patients or visitors. Teaching hospitals that have a large number of residents and/or students making rounds will need larger spaces for confidential conversations. The expanded use of electronic medical record technology is continuing to change the needs and configurations of these spaces.
5. Facilities for medication distribution should support the organization's practices but allow for flexibility. Medication management has evolved over the years from patients lining up at a window at designated times to staff taking medications to patients wherever they are on the unit. While the trend is strongly toward the latter, some facilities prefer the former or some variation of the two. This practice should be clearly defined in every facility's functional program and safety risk assessment. Flexibility should be designed into the built environment to allow for future changes in how this critical function is provided. Medication rooms and/or zones should also be provided in accordance with the requirements of the **FGI Guidelines** and all other applicable codes, standards and regulations.
6. Where possible, locate service areas (such as trash rooms and clean and soiled utility rooms) so they are accessible from both the unit and a service corridor. This eliminates the need for environmental staff servicing these rooms to enter the treatment areas of the unit and possibly disturb patient activities. All doors to these rooms must be kept locked at all times.
7. Traditional nurse call systems for patients to request assistance from nursing staff are not required in behavioral health units by the **FGI Guidelines**. Significant new developments in duress alarm systems greatly improve safety for staff who find themselves threatened by patients. Sensors located in all patient-accessible areas are activated using a small device that the staff members wear.⁶⁵⁰ Staff may activate the alarm when they feel threatened and want other staff to come. Different alarm products annunciate in different ways, but many provide the exact location of the staff member activating the alarm.
8. All electrical outlets in patient rooms are required by the **FGI Guidelines** to be tamper-resistant, hospital-grade units on ground-fault interrupted circuits. The breakers for these circuits should be located so staff can easily access them without entering patient rooms. This is easy to accomplish in new construction but can be very difficult to achieve in remodeling projects. If receptacles with individual reset buttons are provided, they should be wired so that activation of one receptacle's breaker does not deactivate the entire circuit.
9. Where possible, locate water shut-off valves for patient accessible bathrooms in corridor walls so they can be accessed from the corridor by opening a locked access door. This has been successfully accomplished during remodeling projects of existing units as well as new construction projects.

This document is intended to represent leading current practices, in the opinion of the authors. It does not represent minimum acceptable conditions or establish a legal "standard of care" that facilities are required to follow.

10. Where possible, locate serviceable parts of patient room HVAC systems where they can be serviced without entering the room. In new construction, consideration may be given to radiant heating and cooling systems that greatly reduce the need for mechanical devices in patient rooms.
11. Housekeeping rooms should be large enough to lock away carts when not in use. All cleaning materials must be locked inside these carts at all times when carts are in patient areas or corridors and not attended by staff.
12. Smoking areas (if provided) should be outdoors. Furniture should be securely anchored in place. Provision should be made for staff observation without having to breathe secondhand smoke. No wastebaskets should be allowed in these areas. Indoor smoking is not permitted in most facilities, and many hospitals now have smoke-free campuses.
13. At the time of this writing, the **FGI Guidelines** require 100 net usable square feet per private patient room and 80 net usable square feet per patient in semi-private rooms (Section 2.5-2.2.2.2). All requirements of these **FGI Guidelines**, the **NFPA 101: Life Safety Code®** (2012 Edition) and applicable building codes should be carefully followed.

B. Safety

Safety for both patients and staff is a primary concern for all behavioral health facilities.

The level of concern for how the design of the built environment affects the safety of patients and staff is not the same in all parts of a behavioral health unit or facility. The level of precautions necessary depends on the staff's knowledge of the patient's intentions regarding self-harm and the amount of supervision the patient will have while using that part of the facility. Previous editions of this Design Guide have proposed that the level of concern for patient safety in the behavioral health built environment can be separated into five categories (with five being the highest level of concern). The concept is that areas that patients do not enter can be designed similar to other hospitals. Areas that patients will enter have some latitude in design, construction, and what materials can be allowed. The lowest patient accessible areas are spaces that are behind self-closing, self-locking doors and where staff are always present with patients. Much stricter requirements need to be met for areas where patients will be alone for long periods of time with minimal supervision. These levels are discussed in detail below. The concept of this level system has been confirmed by independent and peer-reviewed research (Bayramzadeh, S, *Health Environments Research & Design Journal* 2017, Vol.10(2) 66-80).

Many organizations have adopted this approach of assessing levels of concern based on a functional statement of intended use and have agreed on the level of risk for rooms or spaces with similar occupant functions. However, caution is necessary as some rooms or room functions can fit comfortably into more than one category or sit on a blurry boundary between two categories. As well, the categories do not always anticipate every use of every room. This blurry boundary can result in clinical staff and facility designers basing design choices on assumptions about the use of a room and its corresponding level of concern that may not meet the actual needs of the stakeholders in an operating environment.

(continued on page 13)

This document is intended to represent leading current practices, in the opinion of the authors. It does not represent minimum acceptable conditions or establish a legal "standard of care" that facilities are required to follow.

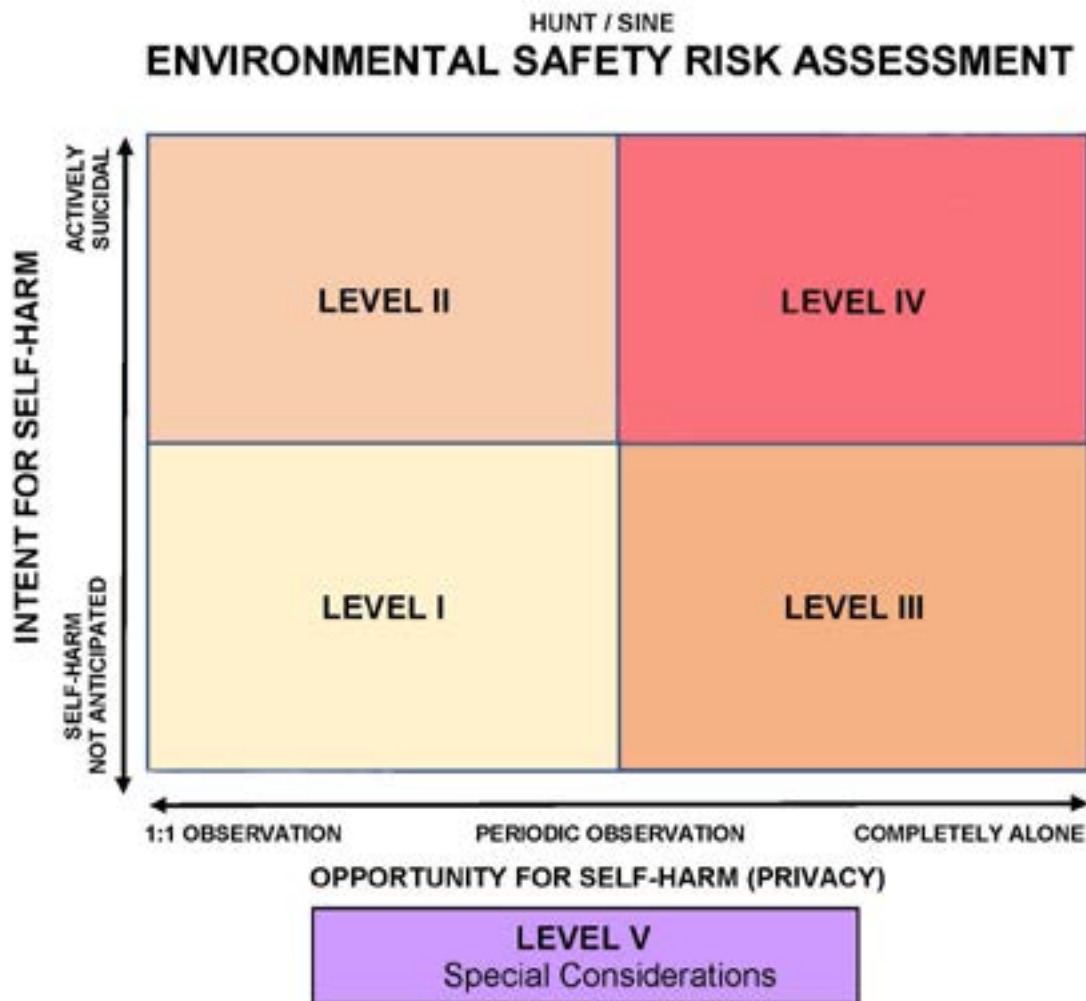

Level I: Areas where patients are not allowed.

Level II: Areas behind self-closing and self-locking doors where patients are highly supervised and not left alone such as counseling rooms, activity rooms, interview rooms, group rooms as well as corridors that do not contain objects that patients can use for climbing and where staff are regularly present.

Level III: Areas that are not behind self-closing and self-locking doors where patients may spend time with minimal supervision such as lounges, day rooms and corridors where staff are not regularly present. Open nurse stations should be considered under this Level

Level IV: Areas where patients spend a great deal of time alone with minimal or no supervision, such as patient rooms (semi-private and private) and patient toilets.

Level V: Areas where staff interact with newly admitted patients who present potential unknown risks or where patients may be in highly agitated condition. Due to these conditions, these areas fall outside the parameters of the risk map and require special considerations for patient (and staff) safety. Such areas include seclusion rooms, examination rooms, and admission rooms.

This document is intended to represent leading current practices, in the opinion of the authors. It does not represent minimum acceptable conditions or establish a legal "standard of care" that facilities are required to follow.

(continued from page 11)

For example, a day room may be located within the sight line of a nurse station that “always has staff present.”

However, if a patient who can’t sleep is in the day room watching television at 2 a.m. and the only staff member on duty is making rounds, the patient may be “completely alone” for a period of time in a space that may contain hazards.

The authors of the Design Guide propose use of an environmental safety risk assessment (ESRA) to facilitate conversation between clinical staff and designers regarding patient safety. The ESRA uses a Cartesian matrix to relate an opportunity for a patient to be alone in a space on one axis to a level of risk of self-harm on the other axis. The greater the opportunity for a patient to be alone, the greater the opportunity for self-harm and the greater the caution that should be taken regarding design choices and materials.

Although patient intent for self-harm is often opaque and difficult to assess, in the matrix we have placed “actively suicidal” on the far end of the scale and describe the opposite end as “self-harm not anticipated.” Privacy ranges from close observation (such as “1:1 observation”) on one end of the opportunity scale and the patient “completely alone” on the opposite end.

This risk matrix is informed by Veterans Health Administration longitudinal studies that have identified frequent locations of acts of self-harm by inpatients, Joint Commission data, and Richard Prouty’s seminal work on risk maps. Designers and clinicians, rather than seeking agreement on what is meant by the name of a room, may now seek to agree on the actual or anticipated degree of aloneness or privacy a patient will experience in a room or space (independent of its name), and it is that agreement that will drive design choices for the room or space.

For example, a patient bathroom in which the patient is anticipated to be alone and have privacy would be far along the privacy axis. If that assessment intersects far along the patient intent for self-harm axis, the space should be designed with the attributes of a Level IV space as described in this document. In sum, no matter the name of the room, a high level of privacy warrants a high level of concern if it is anticipated that patients who are actively suicidal (or patients with an unknown or unassessed intent for self-harm) are to be treated or housed in that space. While different products may be used for spaces with risk assessments located in the Level IV quadrant of the risk matrix than for spaces in the Level I quadrant, the higher risk locations do not necessarily need to look more “institutional.”

The authors believe the use of a tool such as the environmental safety risk assessment matrix will facilitate necessary conversations regarding patient safety and design between operators, clinicians, and designers. However, the tool is not intended to predict risk levels in a facility, which the authors believe to be dynamic and non-static. Rather, it is intended to encourage dialog and promote a common understanding of the patients a designed space is intended for and the risks of that anticipated patient population.

Also note that use of the matrix should not be interpreted as a suggestion that patient privacy is not important or is a risk to be avoided. On the contrary, privacy is generally considered

Construction and Materials Considerations

Each level of concern in the patient safety risk assessment matrix requires increased attention to the built environment to reduce the potential for patients harming themselves or others. There truly is no “one-size-fits-all” solution to the design of these environments. Many factors must be considered and the patient populations, staffing patterns, organizational culture and challenges of the existing built environment are unique for each unit of each facility. The authors suggest the following baseline set of considerations from which the staff of an organization can begin their considerations of what is the best solution for their facilities. The following suggestions may be adjusted to be either more or less restrictive as desired for individual applications.

A. Baseline considerations for patient areas

For the purposes of this document, the Authors have designated the needs of Level III spaces to be the Baseline for suggested conditions. Some items may be somewhat less stringent for Level II areas if such items are consistent with the Safety Risk Assessment as well as TJC and other regulatory requirements. Some items may need additional attention for Level IV and V areas as discussed in their sections.

Blind spots in corridors and other areas where patients cannot be observed from an attended staff station. All unattended rooms are suggested to be locked at all times to reduce the possibility of patients entering them.

1. Openings

a. Doors:

- i. Barricade Risks – The direction of swing is very important. Doors that swing into any room which patients may enter can be susceptible to being barricaded by patients. This can be either intentional or accidental (if a patient should lose consciousness and fall against the door). In either case, it can be very difficult for staff to enter the room when needed. If intentional, it can be to attempt self-harm or to inflict harm on a staff member or another patient. This risk can be mitigated in several ways:

- **Out-swinging doors** – Doors that are hinged to swing out of the room are more difficult to barricade but may create issues with the Life Safety Code and other building codes by restricting the width of exit passageways. This may be addressed by recessing the door back from the face of a corridor wall which may create an alcove that is difficult to observe. **The FGI Guidelines warn that alcoves are to be avoided.**
- **Double-acting doors** – doors that are hinged to normally swing into a space, but staff may release to swing out of the space is one option to the barricading risk. The hardware needed for this solution is discussed below in the Door Hardware section.
- **Wicket doors** – These are single in-swinging doors that have a portion of the that is locked in the closed position and is hinged to swing out of the room. This can allow access to the room if barricading occurs.
- **Unequal pair of double egress doors** – If there is sufficient length of corridor wall present, a pair of doors can be provided. The active leaf is normal width and for normal use and is hinged to swing into the room. The inactive leaf is narrower and hinged to swing out of the room when unlocked by staff for emergency access. These can be done with or without a vertical frame member (mullion) between the two doors. Providing the mullion allows less complicated hardware and quieter operation. Not providing the vertical frame member results in additional opening width that is sometimes desirable.
- **An additional door** can be provided (preferably out-swinging) that can be used by staff to leave the room or for other staff to enter the room. This can be an effective safety measure. The additional door may be into an adjacent room such as an office if the door is not needed for code compliance reasons. All “additional doors” provided for this purpose will need to be barricade resistant and meet all applicable codes and regulations.

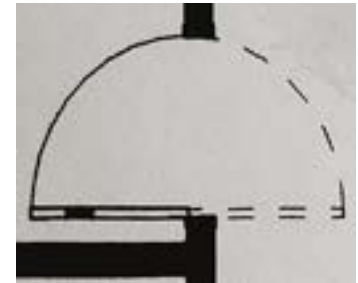
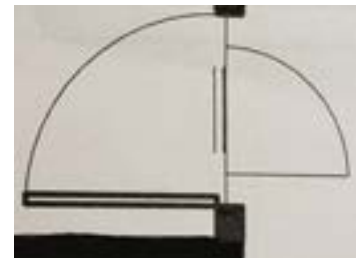
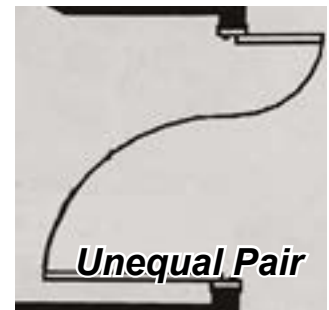
**Out Swing Alcove****In Swing - Dbl Act'g.****In Swing - Wicket****Unequal Pair**

- ii. Door materials – Doors in behavioral health facilities are subject to heavy use and possibly extensive abuse. They make up a significant percentage of the exposed wall surface in corridors and thus have a strong visual impact on these spaces.
- Painted steel doors are durable, easily touched up or refinished, but more institutional in appearance. Doors with wood veneer faces and stain and varnish finish are more “residential” in character but are easily damaged and difficult to repair. Plastic laminate is easily chipped and may yield sharp objects that may be used as weapons and is never advised in these facilities. If existing doors have plastic laminate for exposed surfaces it may be desirable to provide stainless steel kick plates, door edges, and other add-on devices, although these can add to an institutional look. (NOTE: The installation of kick plates may invalidate the fire rating of doors in some jurisdictions.) Kick plates and other protective devices are also available in durable synthetic materials that come in a variety of colors, which soften the stainless-steel look but can still result in a patchwork appearance.
 - Durable Synthetic Facing - A possible solution to these issues is doors faced with a durable synthetic that has a wood grain appearance. Some of these doors have removable end caps,^{25a} which can be replaced if they become damaged at much less expense than replacing the entire door. Doors with synthetic faces without the replaceable end caps^{25b} are available for a lower initial cost.

Although the first cost for these synthetic-faced doors is higher than for doors of other materials, they do not require the added expense of finishing the doors and purchasing and installing kick plates, etc. Thus, the life cycle cost can potentially be less than for other doors, and the appearance over time may be a significant improvement.



b. Door Hardware – Hardware on doors that connect to a higher Level of Risk shall have hardware suitable for the higher level of risk.

- i. Hinges: Geared-type continuous hinges are preferred for all doors patients will pass through and normally locked doors that have hinges exposed in patient accessible areas because they minimize possible attachment points. These hinges are available from various manufacturers with a “hospital tip” (factory installed closed-sloped top) and continuous gears that resist ligature attachment.¹¹¹ Field cutting the top of hinges to create this slope is strongly discouraged because that often exposes voids that may be used as ligature attachment points.

Geared continuous hinges do provide significant pinch points between the two leaves of the hinge when the door is closed. If this is not an acceptable risk to an organization, double acting continuous hinges that do not have this pinch point¹¹³ can be provided.

- ii. Double-acting continuous hinges¹¹³ can be used on patient room-to-corridor doors to counteract barricading without the hazard presented by pivot hinges. These continuous hinges can be paired with full-height emergency stops¹¹⁵ that lock in place and can be easily unlocked to allow the door to swing into the corridor.
- iii. Wicket doors⁴⁴ use single acting continuous geared hinges with hospital tips for the main door and the center portion is mounted on a continuous geared hinge with hospital tip (or concealed) hinge and secured with a deadbolt lock that has no visible hardware on the room side of the door. Care should be taken with the detail of the edge of the smaller panel so that a crack is not provided that can be seen through and is smoke tight if required.
- iv. Unequal pair of double egress doors - Both doors may be mounted on single acting continuous geared hinges with hospital tips. The lockset can be the same as any other single-acting door. If the mullion is not provided, a deadlock with concealed flushbolts that engage the head of the door frame (and possibly the floor) is needed for the smaller inactive leaf. This deadlock is preferred to not have any visible hardware on the room side of the door. If the mullion is provided, a deadbolt that does not

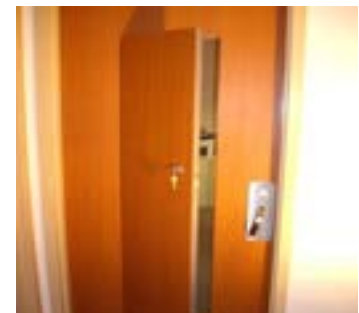

have any exposed hardware on the inside can be used to secure the door into the mullion

- v. Closers – See Level II
- vi. Locksets – Use of some type of ligature-resistant lockset is recommended for all door handles in patient-accessible areas. A lockset handle can be used for ligature attachment in three ways: pulling down, pulling up and over the top of the door, and tying something around the latch edge of the door using both the inside and outside handles (transverse). The latchbolt itself has even been used successfully as an attachment point and some companies offer a tapered bolt to help with this. The downside to the tapered bolt is that it makes it easier to open a locked door by using a small piece of cardboard or other item. Also, the opening behind the strike plate can be a ligature attachment point; for this reason, a box should always be provided behind the strike plate. In our opinion, the perfect solution for this dilemma does not exist at this time. Several of the better options are discussed below.

- Locksets with a Lever Handle¹³⁰ – These effectively reduce the level of risk of up and down pressure but are susceptible to transverse attachment. The lever should move freely in both directions when locked to reduce ligature attachment risks. This type of handle is more typical (less institutional) in appearance and operation than other choices. Both of these qualities are very desirable in items that patients will touch and use on a regular basis. However, lever handles may be susceptible to transverse attachment as mentioned above.
- Crescent Handle Lockset¹³⁶ – This type of lockset has a lever handle and thumb turn that are ligature-resistant and may meet ADA requirements. It is available with a handle that can be mounted in either horizontal or vertical position and allows the user's hand to easily slip off the free end.
- Push/Pull Hardware – This type of door handle is available with a flush push pad on one side and a ligature-resistant pull handle on the other.^{137b}

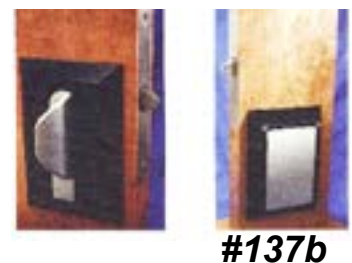

- Modified Lever Handles¹³¹ – These provide minimal ligature attachment risk but have an unusual appearance and operating motion. They are available in various designs.
- i. Elopement Buffers (generally called sally ports) – The 2018 Edition of the **FGI Guidelines** calls for the “*primary access point to the locked unit to be through a sally port*” (Section 2.5-2.2.1.2). The Appendix for this section states that a sally port has two doors (or two sets of cross-corridor doors) that are electrically interlocked¹⁴⁴ and “the sally port should be long enough and the door wide enough to accommodate passage of a bed or laundry cart.”
 - ii. Access Control of elopement buffers (sally ports) and other entry/exit points from a locked unit, including stairways.



#131a



#131c

The Safety Risk Assessment should state whether normally locked unit exit doors are going to automatically unlock when the fire alarm is activated (fail safe operation) or remain locked when the fire alarm is activated (fail secure operation). This determination should be reviewed with the local code authority for compliance with local regulations.

- Provide intercom (or telephone) for communication to staff stations from outside the unit if needed.
- Electronically controlled access systems are preferred for sally ports. These may be operated by a switch at the nurse station if the door is clearly visible from the location of the release button. (Care should be taken to assure that patients are not in the area when the door is released.) Card readers or keypads adjacent to the door are also commonly used. These are readily available from hardware suppliers and are often extensions of systems already in place at the facility.
- Metal Detectors⁶⁶⁰ – Some organizations have expressed the desire to use metal detectors to assist



#660

with screening patients and/or visitors entering their behavioral health facilities. Some choose to use hand-held detectors and others use standard walk-through detectors. These are addressed under Electronic Safety in Section 10 below.

iii. Cross-Corridor Doors – These doors are provided for several reasons, and each has its own unique function and requirements. Some are part of code required fire rated partitions and normally held open and others are to restrict patient or public access and normally locked and may automatically unlock when the fire alarm is activated (fail safe operation) or remain locked when the fire alarm is activated (fail secure operation).



- When there is concern that electromagnetic locks may not be sufficient to hold these doors when impacted by patients, concealed deadbolts with the electric release in the lever handle¹⁰⁹ (or card reader) or electric strikes (for single doors) may be provided. Electronically controlled access systems are preferred.
- Door closers may be required or desired for these doors depending on their purpose and function. Doors that will be held in the open position will probably have an exposed arm that should be acknowledged in the Safety Risk Assessment as a known risk that the staff needs to be aware of.
- Magnetic hold-open devices where required or desired for doors that are to be normally open and must close when the fire alarm is activated and are suggested to be as discussed below.
- Hinges for these doors are preferred to be continuous geared hinges with hospital tips. Pivot hinges are discouraged because the top pin is presents a serious ligature attachment risk.

iv. Hardware for other unit doors

- Doors for which applicable codes and regulations require a closer but that need to be open to allow staff observation of patients are preferred to be provided

with a closer that has a built-in release¹⁰¹ that allows the door to close automatically when the fire alarm is activated. The more standard magnetic hold open devices that are separate items provide ligature attachment risks and are less desirable.

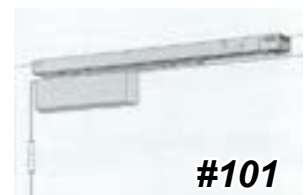

- Doors that swing into rooms that patients will enter, are strongly suggested to have one of the barricade-resistant methods discussed above.

v. Door Smoke Seals – These may be required in some situations and are often applied with adhesive strips that can allow patients to remove them to use as ligatures. Smoke seals that break into 8"- long pieces¹⁰ are preferred for use on all doors that patients will pass through. These are available from several manufacturers.

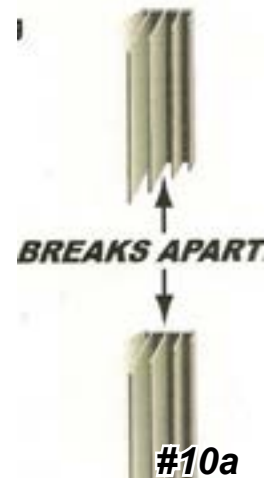

vi. Door Hardware for patient use toilet and shower room doors that open into patient accessible areas other than patient bedrooms are suggested to have the following:

- Full-size, tight-fitting doors
- Out-swinging geared continuous hinges with hospital tips or double acting hinges with emergency release stops
- Ligature resistant handles and storeroom function locks
- Closers that are either concealed or not mounted on the toilet or shower room side of the door.
- Over door alarms

vii. Over Door alarms - The top of all tight-fitting doors provides a pinch point that allows a patient to tie a knot (in a sheet, the leg of a pair of jeans, or other object), place it over the top of the door, and close the door to create a hanging device. One way to reduce this risk is with a pressure-sensitive or photoelectric device placed near the top of the door that can sound an alarm¹⁵⁰ when activated. The bottom of doors can also present a risk if the gator roll technique is attempted. One product will detect this also.



c. Windows - When glazing that is exposed in patient-accessible areas is broken it needs to stay in the frame and not yield sharp shards that patients could use as weapons. Terminology can be confusing in that laminated glass like that used in vehicle windows is often referred to as “safety glass” but, when broken, can yield large sharp pieces. All glazing materials that are exposed in all patient accessible areas should be considered, including the exterior surface of windows accessible from exterior courtyards to be used by patients.

The 2018 edition of the **FGI Guidelines** contains the following reference to window testing:

2.5-7.2.2.5 Windows...

- (1) Windows located in patient care areas or areas used by patients, including the exterior pane of windows accessible by patients for outdoor courtyards, shall be designed to limit the opportunities for patients to seriously harm themselves by breaking the windows and using pieces of the broken glazing material to inflict harm to themselves or others.*
 - (a) All glazing (both interior and exterior), borrowed lights, and glass mirrors shall be fabricated with polycarbonate or laminate on the inside of the glazing or with any glazing that meets or exceeds the requirements for Class 1.4 per ASTM F1233: Standard Test Method for Security Glazing Material and Systems.*
 - (b) Use of tempered glass for borrowed lights shall be permitted.*
- (2) To prevent opportunities for suicide, self-harm, and escape, the entire window system and the anchorage for windows and window assemblies, including frames and glazing, shall be:*
 - (a) Designed to resist impact loads of 2,000 foot-pounds applied from the inside*
 - (b) Tested in accordance with AAMA 501.8-13: Standard Test Method for Determination of Resistance to Human Impact of Window*

Systems Intended for Use in Psychiatric Applications. Where operable windows are used, hinges and locking devices shall also be tested.

Advances in different types of safety glass (see “Glazing” below in this section) make it worthwhile to consult an expert for advice for a specific project.

- i. Exterior Windows – The height above the ground, patient population, and many other factors should be taken into account in choosing these materials. Comply with the **FGI Guidelines** and all applicable codes and regulations for glazing, frame installation and operable sash.

In locations where the building’s prime window does not meet the requirements of the **FGI Guidelines**, an additional layer is sometimes provided inside of the prime window to provide the required protections.

- ii. Interior Windows - These do not have the same concerns of falling from heights as exterior windows, but breakage concerns are similar. Careful attention should be paid to fire-rated partitions and all applicable building and fire code regulations as well as the **FGI Guidelines’** requirements listed above.

Some facilities prefer to use painted hollow metal window frames for these windows because they have rounded corners and aluminum frames often have very sharp corners.

- d. **Operable Windows** – Windows in all patient-accessible areas should comply with all applicable codes and regulations for operable sash. Where operable windows are provided, they should be equipped with sash control devices that limit the opening to 4 inches per the ADA 4” ball test and that, where required, can be released to full opening using a key for evacuation purposes. Window systems are also available that allow fresh air⁶¹ through a vent at the bottom or by sliding the window open a few inches.

e. **Glazing - (Interior and Exterior) –**

- i. Standards – All glazing in patient-accessible areas should be security glazing as discussed in the **FGI Guidelines’** subparagraph “c” above.



#61b

ii. Impact-Resistant Glass Products – Several glass manufacturers²⁰⁰ offer products that may be appropriate for use in behavioral health facilities. The products chosen will vary depending on the size of the opening, type of frame, patient population being served, and location of the glazing in the unit (as determined by the patient safety risk assessment) including the distance the opening is above grade. We suggest contacting manufacturers directly to determine which products may be appropriate for a specific project.

- Fire-Rated Glass²⁰⁵ – Clear fire-rated glass products are now available in a variety of types and ratings and some are rated for impact resistance.



- Glass-Clad Polycarbonate Glazing²⁰⁰ – Two layers of heat-strengthened glass are bonded to a polycarbonate core. This combination keeps the broken material in the frame and reduces patient access to shards of glass that could be used as weapons and is usually available in 7/16” and 9/16” thicknesses. This type of product has been known to be available for lower cost than polycarbonate glazing for some projects.



- Heat-Strengthened Glass – Although more difficult to break than regular float glass, heat-strengthened glass has about half the strength of tempered glass. Heat-strengthened glass may be a good choice if it is laminated and high-impact resistance is not required for the location.

- Polycarbonate²⁰¹ (Lexan) – Polycarbonate panels are highly impact-resistant and available in a variety of thicknesses from several manufacturers. These products will deflect upon significant impact near the center of large panels that can result in large pieces coming out of their frames. Care should be taken to assure that the depth of the stop securing the panel will be able to hold it when subjected to this and other impacts. This material is also highly susceptible to scratching and is a frequent target of patients who write profanity and draw pictures. Mar-resistant coatings are available, but they do not eliminate this concern. Recent projects have indicated this may be

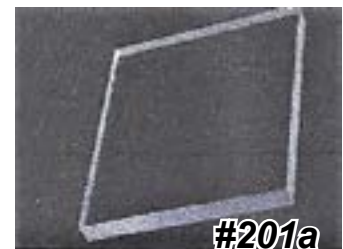

the more expensive than glass-clad polycarbonate products.

- Security Film – If replacing existing glass is cost-prohibitive, applying a window film security laminate¹⁹⁰ to existing glass may be an alternative. Although these films are susceptible to scratching and defacement by patients, they may be removed and replaced at less cost than replacing glass or polycarbonate panels. The manufacturer's installation instructions should always be carefully followed including any impact-protection adhesives and a perimeter attachment system needed to hold the glass in the frame if broken. In our opinion, claims that these window films will prevent glass from breaking should not be relied upon.
- Tempered Glass – This may be acceptable for use in some patient-accessible areas such as small windows in doors, portions of glass walls separating activity rooms from corridors, and patient toilet room mirrors. Tempered glass is more impact-resistant than float glass or laminated glass but will break into many small pieces and fall out of the frame, which may allow a patient to elope. As well, each piece may have sharp edges. Patients have been known to break tempered glass mirrors and rub the inside of their wrists on the broken surface to cut themselves or swallow the small pieces of glass. This hazard may be reduced by covering the tempered glass with a security film as described below.
- Laminated/Heat Strengthened Glass²⁰⁰ - Two layers of heat-strengthened glass bonded to a Sentry Glass Plus (SGP) interlayer, which helps the glass stay in the frame when broken..
- Wire Glass – Standard wire glass will break and yield sharp shards of glass and is generally not permitted by many current codes and regulations. There are new wire glass^{205b} products that are rated for both security and fire by their manufacturers that may be considered. Verification with local AHJ is always recommended before purchasing new products.



f. Window Coverings –

- i. Mini-Blinds – Mini-blinds mounted behind safety glass²⁰⁰ are preferred because the blinds are not accessible to patients. Care should be taken to assure that any exposed devices for controlling the tilt of the blinds do not create a potential ligature attachment point. Some commercially available window assemblies have all these features.⁴³⁰ Exposed mini-blinds are discouraged because they provide access to long cords, wands and slats.
- ii. Roller Shades⁴⁴⁰ – Roller shades specifically manufactured for use in psychiatric hospitals are another option.

These have enclosed security roller boxes, security fasteners, cordless operation, and locking devices that resist tampering by patients may be acceptable for some patient populations. If access to these blinds by patients is deemed not acceptable by the Safety Risk Assessment, electrically operated standard roller blinds may be installed behind security glazing.

- iii. Electrically Obscured Glazing ²²¹ is becoming more reasonably priced and is an option for controlling privacy as long as the glazing material meets the requirements of the **FGI Guidelines** for glazing in patient areas.
- iv. Curtains and Curtain Tracks – Curtains and associated tracks of any type (including those designated as “breakaway” and represented by their manufacturers as “safe for psychiatric hospitals”) are NOT recommended for use in any patient-accessible areas, especially patient rooms and patient showers.

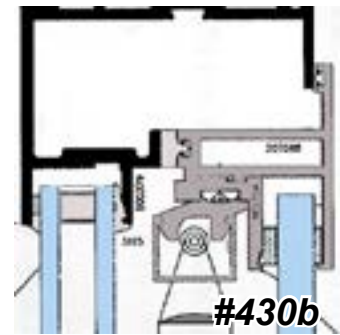

2. Finishes

- a. **Gypsum Board** – Abrasion-resistant and impact-resistant gypsum board^{230, 231} hung on 20-gauge or heavier metal studs spaced no more than 16 inches on center is typically considered minimum construction for these areas. Sound-deadening gypsum board²³² is available to help reduce noise levels from traditional hard services. Consult manufacturers regarding the characteristics of the material determined most

appropriate for a particular installation. These products are available from several manufacturers.

A painted finish is preferred because it is easy to repair and the cost of renewing or changing colors to keep up with current trends is relatively low. Also, painted finishes help create a residential or home-like ambiance while still meeting institutional requirements.

b. Ceilings – Ceiling heights lower than nine-foot-high are discouraged because it is easy for patients to reach them and tamper with the ceilings and ceiling-mounted devices. Ceiling heights of nine feet and above are not immune from tampering and must be evaluated in the Safety Risk Assessment for each area of each unit.

- i. Tamper-resistant ceilings are preferred for all areas of a behavioral health facility. If sound attenuation for gypsum board ceilings is desired, sound absorbing gypsum board²³² may be used or 1'x1' acoustic tile can be adhered to the gypsum board.
- ii. Where accessibility to mechanical, electrical, and communication equipment is needed, The Joint Commission's November 2017 Edition of Perspectives (modified by subsequent FAQ's also published in later editions of Perspectives) currently allows unsecured lay-in ceiling to be used under certain circumstances. As of this writing, the authors are not aware of any manufacturer who produces hold-down-clips that are specifically recommended for use to limit patient access above the ceiling. Systems relying on hold-down clips always result in the last tile being placed not being secured unless some form of locked access panel is provided to allow installation of the clip on the last tile.
- iii. There are several tamper-resistant solutions that can reuse the existing ceiling grid system and may be less expensive than typical gypsum board ceiling installation that may be considered:
 - Remove existing ceiling tile and install specialty 2'x2' metal ceiling panels²³⁹ with tamper-resistant screws in the recessed joints to resist removal. This system will

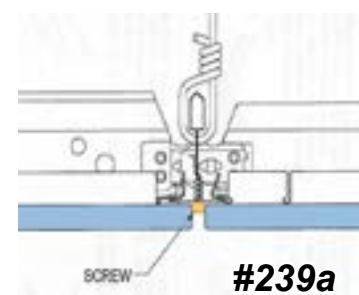

allow access at any point and is available in sound absorbing models.

- Remove existing ceiling tile and install special clips²³⁴ that are made to fit over existing grid members that are at least intermediate grade steel system (not aluminum). Then attach 5/8" thick sound absorbing gypsum board ceiling (mud and tape joints – paint) to these clips. Lockable access panels will be required at all necessary locations. It may be necessary to support light fixtures, etc. independently of the existing grid to avoid overloading the carrying capacity of the existing grid.

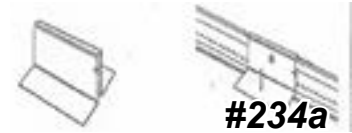

- b. Wall Base –** Use of thin, flexible rubber or vinyl baseboards that are applied only with adhesive and are intended to cover the joint between the wall and floor is strongly discouraged. These become prime targets for patient tampering and can be used to conceal contraband.

There are several alternative choices for base material and installation that may offer less risk:

- i. i. Seamless epoxy flooring²⁵⁰ that has an integral covered base is an option as long as there is no metal or plastic edge strip on the top of the base.
- i. ii. A premolded base²⁴⁰ that extends onto the floor plane, finishes flush with the top of the floor tile, and is heat-welded to the flooring may be acceptable in some locations. However, use of this product does not address the issue of hiding contraband unless the top edge is sealed with a pick-resistant sealant.²⁰
- i. iii. A thick rubber base that resembles wood base profiles²⁴¹ is available and provides a more “residential” appearance. All joints to the wall and floor and all vertical joints should be sealed with a pick-resistant sealant.²⁰
- i. iv. In some cases, a wood base with a minimum 3/4” thickness that is adhered to the wall, secured with countersunk tamper-resistant fasteners, and sealed with pick-resistant sealant²⁰ has been used successfully. If

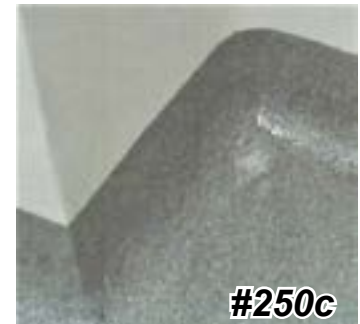

desired, this can be given a semi-transparent stain finish to provide more of a residential look.

- b. Flooring** – Carpet²⁵⁵ or sheet vinyl²⁴⁵ meeting class A rating should be used. Avoid patterns and color combinations that may appear to “animate”, abrupt contrasting color changes that could appear as objects that need to be stepped over or other visual misperceptions by patients. Anti-microbial sheet carpet (formerly called “broadloom”) with solution-dyed yarn and moisture-resistant backing²⁵⁵ is effective in reducing ambient noise and generally works well in these facilities. This is available from most major carpet companies. Sheet vinyl²⁴⁵ or other hard surface material is preferred where wet or potentially messy activities will be conducted.

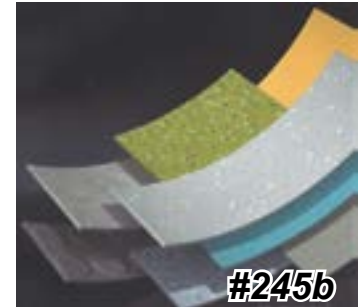

- c. Abrasion Resistant Coatings**²⁸⁰ – Any areas where excessive wear is anticipated, such as corridors and seclusion rooms without wall padding may be coated with paint materials that have more resistance to abrasion and possible abuse.



3. Specialties

a. Signage – Room Signs³⁰⁰ –

- i. Flexible room signs are available that are applied with adhesive and will not provide a weapon to patients if removed. These can include braille lettering and meet ADA requirements.
- ii. Rigid room signs^{300d} that are installed with multiple tamper-resistant screws are more difficult to remove and also can include braille lettering to meet ADA requirements.



- b. Corridor Handrails** – may not be required in behavioral health units but may be indicated as needed by the Safety Risk Assessment because of needs of the patient population being served having equilibrium issues due to medication side effects or other reasons. If these are provided, there is a choice between leaving the anchors for the rail exposed (which creates ligature attachment point opportunities) and providing a solid filler between the rail and the wall (which helps reduce ligature attachment points and creates a place for trash to collect and can be an infection control cleaning problem). The “correct” answer for any given section of



railing will depend on the facility's Safety Risk Assessment and the amount of observation of the specific location.

- c. Wall Protection** – Large sheets of durable wall protection material are available in solid color finish or with a wide variety of printed artwork.³²⁰ However, the standard vinyl trim pieces that come with this material are not recommended for use in behavioral health applications. Rather, the edges of the material are suggested to be tightly fitted together and sealed with pick-resistant caulk.²⁰



- d. Toilet Accessories** – See Level IVb

e. Mirrors and Domes:

- i. Mirrors - Glass-laminated polycarbonate mirrors in ligature resistant wood frames³⁶⁰ offer an option with a residential appearance and are scratch resistant. (See also Level IVb-3f for toilet room mirrors)
- ii. Observation Dome Mirrors – Convex mirrors installed in corridors, seclusion rooms, and other patient-accessible locations to assist with observation of patients are preferred to be made of a polycarbonate that is a minimum of 1/4" thick, filled with high-density foam, and have a heavy metal frame that fits tightly to the wall and ceiling.⁴²⁰ Convex mirrors made of polished steel are also available. The perimeter of the mirror is recommended to be sealed with pick-resistant caulking.²⁰



- f. Pick-Resistant Caulk** – Pick-resistant caulking²⁰ is strongly suggested for all joints between objects and surfaces that do not fit tightly and may provide opportunities for patients to hide contraband, attach ligatures or grip items to remove them. It is preferred that this material not set up hard (like epoxy) but remain pliable and be able to move with its substrate over time. Verify compatibility with all adjacent materials before application.



- g. Paper Trash Receptacle Liners** - Coated paper liners¹ are strongly suggested for all trash receptacles to which patients have access including large receptacles in dining and activity spaces. Paper liners with rope handles may present ligature risks. Plastic liners should be prohibited because of the risk of suffocation.



h. Kitchen Equipment Considerations - (Levels II and III only)

4. Furnishings

a. Built-in Cabinets - (securely anchored in place)

i. Cabinet Doors -

- All cabinets that contain items that patients are not to have access at all times they are present in the space are strongly suggested to have lockable doors.
- Cabinets that contain items that patients are allowed to access at all times they are in the space are strongly suggested to not have doors and to have shelves that are securely fixed in position to resist both upward and downward pressure. Adjustable shelves are discouraged because they are easily removable and may be used as weapons.

ii. Cabinet Pulls – These are suggested to be recessed, with no protruding openings, or of a closed ligature-resistant type.⁴⁶⁰

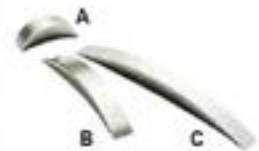

#460a

iii. Cabinet Locks – These are very important in all patient-accessible areas. Cabinets used to store items that patients could use to harm themselves or others should be kept locked at all times when patients are present. This can lead to staff constantly looking for the right key on a large key chain. One solution is to provide locks that can be unlocked with a key that staff already carry, such as the key used to activate the fire alarm. Another solution is to use existing key access cards or a pushbutton keypad.⁴⁶⁵ These are becoming more affordable and should be particularly helpful in examination/treatment rooms and any locked cabinets in patient rooms.



#465a

b. Decorative Crafts - Pictures and Artwork – All pictures and artwork in patient-accessible areas must be given special consideration:

- ##### i. Murals – These can brighten and add interest to corridors and day rooms and have been used very effectively in some facilities. It is usually a good idea to cover them with at least two coats of a clear sealer for



protection, but patients typically enjoy these and defacing them is not usually a problem. Murals are also available on wall vinyl and wall protection materials.

- ii. **Wall Protection** – Large sheets of durable wall protection material are available with a wide variety of printed artwork.³²⁰ However, the standard vinyl trim pieces that often come with this material is not recommended for use in behavioral health applications. Rather, the edges of the material could be tightly fitted together and sealed with pick-resistant caulk.²⁰



#320b

- iii. **Frames** – Specially designed frames⁴⁷⁶ that slope away from the wall and have polycarbonate²⁰¹ glazing are recommended. The frames that are screwed to the walls with a minimum of one tamper-resistant screw⁴⁷⁰ per side are preferred to provide a tight fit to walls which may have uneven surfaces. The joint at the top is suggested to be sealed with a pick-resistant sealant.²⁰ Some of these frames allow for easy replacement of the images and provide the opportunity for patients to customize the displays with personal photos, etc.



#476b

- iv. **Printed Flexible Vinyl** – Another option is to print artwork on flexible vinyl³⁰¹ that can be attached to walls with low-tack adhesive or regular wall vinyl adhesive for more permanent installations. This method reduces the risk of patients obtaining harmful materials. The low-tack adhesive used on smaller images makes it easier to change the art displayed on a seasonal or other basis and allows hospitals to offer patients a choice of artwork to display in their rooms, giving them some control over their environment.



#482h

- c. **Seating** - Furniture used in behavioral health facilities is preferred to be easily cleaned, easily reupholstered, very sturdy, and as heavy as possible to minimize the likelihood of patients throwing chairs, tables, etc. Where indicated by the Safety Risk Assessment, furniture is suggested to be securely anchored in place or weighted to resist stacking or barricading of doors. Closed arms and legs are preferred to resist attachment of ligatures and breaking into items that could be used as weapons.⁴⁸² Upholstered lounge chairs with arms⁴⁸² that resemble typical residential furniture are generally preferred, but polyethylene rotationally molded⁴⁸³ and sand-ballasted seating is now available with a less institutional look. The health care organization should select



#482a



#483

This document is intended to represent leading current practices, in the opinion of the authors. It does not represent minimum acceptable conditions or establish a legal "standard of care" that facilities are required to follow.

furniture appropriate for the patient population served and the location on the unit for which it is intended.

Where movable seating is needed (e.g., dining and activity rooms), very lightweight polypropylene chairs⁴⁸⁰ that resist breaking into sharp pieces are preferred. An alternative is a chair that can be partially filled with sand (or otherwise have weight added) to make it difficult to throw or use as a weapon.⁴⁸⁰



Comfort Rooms and other lounge areas may have specialty or chaise lounges⁴⁸²ⁱ or bean bag^{481d} type seating that are manufactured without zippers and with very durable materials and seams.



Rocking motion has long been believed to be soothing and several companies now offer specially designed seating that allow a rocking motion.⁴⁸³ Care should be taken to realize that it is not uncommon for unauthorized movement of furniture from a low-level risk area to a higher risk area of a unit to occur. This may result in unintended risks being created.



All upholstery and foam used in furniture should have flame-spread ratings that comply with the requirements of Section 10.3 of **NFPA** 101: Life Safety Code®.



d. Furniture:

- i. Tables for dining and activities are available with enclosed legs⁴⁸⁵ and provide less opportunities for ligature attachment. These are usually either center pedestal or “X” base style. Both can be weighted down with sand to reduce the chance that they can be picked up and thrown but can still be movable. A range of styles and shapes of tops are available for both types.



- ii. End tables and coffee tables are available in enclosed cubes or drums^{485c} and other configurations that are also ligature resistant and can be weighted.
- iii. Shelving units for items to which patients will have free access are suggested to be sturdy, have open shelves that are fixed in place (not adjustable) and securely anchored in place including the top of taller units to resist them being tipped over.



#485c

5. Fire Suppression

- a. **Fire Sprinkler Heads** - Institutional heads⁵²⁰ that are ligature-resistant are preferred.
- b. **Fire Extinguisher Cabinets** - All fire alarm pull stations and all fire extinguisher cabinets⁵²¹ are suggested to be locked (with approval of all applicable code authorities). All staff on duty must carry keys for these at all times. These keys should be provided with a red plastic ring or other means of providing quick identification. In addition, fire extinguisher cabinets are preferred to have continuous hinges, recessed pulls (if any), and polycarbonate glazing if view windows are provided.



#520a



#521a

6. Plumbing Fixtures and Fittings

- a. **Toilet Fixtures** – Patient accessible toilets are always considered Level IV and V areas and are addressed in those sections.
- b. **Sinks** –
 - i. Standard stainless-steel sinks may be permitted if that is consistent with the organization's Safety Risk Assessment and are suggested to be designed into recesses with doors or roll-down shutters that can be locked when staff are not present.
 - ii. Bathroom sinks are addressed in Level IV and V sections.
 - iii. Hand-washing sinks for staff that are in patient accessible areas are suggested to be specially designed units. See subparagraph "h" below.

c. Showers - Patient accessible showers are only permitted in Level IV and V areas and are addressed in those sections.

d. Faucets – Patient use faucets are primarily inpatient bathrooms and are addressed in Levels IV and V. Faucets in activity and similar rooms are addressed in Levels II and III.

e. Flush Valves - Patient accessible flush valves are permitted only in Level IV and V areas and are addressed in those sections.

f. Water Stations – Ligature-Resistant Drinking Water Stations⁵⁸⁹ – Drinking fountains are often required or desired in common spaces on units. Typical drinking fountains can be problematic for ligature and infection control reasons but requiring patients to ask staff every time they want a drink of water can rank high on patient dissatisfaction surveys.

To address this issue, consider use of water cup-filling stations in patient-accessible areas. Several options are available for cup-filling stations⁵⁸⁹ that have either local or remote refrigeration units, in both wall-mounted and counter-top styles.

g. Medical Gases – These are not normally required for behavioral health units. If there is medical necessity or the outlets are a preexisting condition in remodeling projects, they should be covered with lockable panels⁵⁹⁰ or panels attached with tamper-resistant screws. These should be removed only to address the medical needs of the current patient and replaced when that patient is discharged or moved. Special care must be taken in areas where other patients may be present to assure that access to the medical gases does not present a safety risk to them also. Some manufacturers offer lockable covers for outlets.

h. Staff Hand-washing Stations - Staff Hand-washing stations⁵⁴⁵ for patient accessible areas are now available that provide less risk than standard fixtures. These are recessed and have integral soap dispensers and air dryers to eliminate the need for separate dispensers which may also provide risks. All hand-washing sinks that are accessible to patients need to be ligature-resistant.



#589b



#590b



#545



7. HVAC

- a. Diffusers, Registers and Grilles** - Grilles with small perforations⁶⁰² or with “S” shaped vanes⁶⁰⁰ that comply with the National Institute of Corrections standards and are secured in place with tamper-resistant fasteners are generally acceptable in patient accessible areas if allowed by the Safety Risk Assessment.
- b. Where existing fan/coil units** (as well as fin-tube heaters or old-style radiators) are present in patient accessible spaces, they are strongly suggested to be protected with vandal-resistant covers.⁶⁰⁶
- c. Thermostats** – Existing pneumatic or electric thermostats may be acceptable for use in patient accessible areas if allowed by the Safety Risk Assessment. If they are found to be problematic, there are covers available to reduce the risk of patients tampering with them and gaining access to small parts which they could use to harm themselves or others. However, sometimes these covers draw more attention to the thermostats and encourage tampering. If these become an issue or are an identified risk in the Safety Risk Assessment, consideration could be given to relocating the thermostats to return air ducts or use of aspirating or thermistor units that are mounted behind a stainless-steel cover that is flush with the wall.⁶⁰⁷

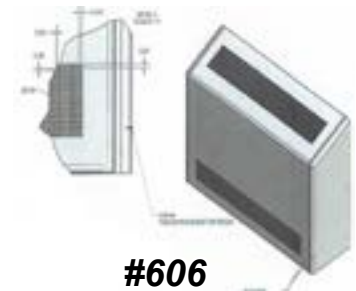
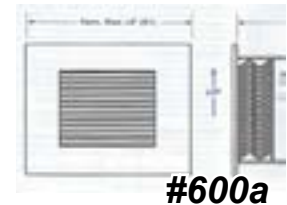
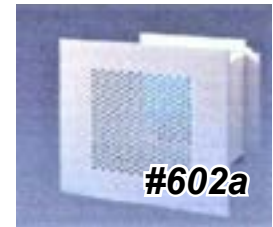

8. Electrical

a. Electrical Devices:

- i. Receptacles - In new construction or major remodeling, the **FGI Guidelines** require a dedicated circuit for all electrical outlets in each patient room and bath. This will allow power to the outlets in a specific room to be turned off if necessary for a patient's safety. Control of each circuit should be located where only staff have access. Where this is not practical in an existing facility, the outlet may be temporarily covered.
- ii. The **FGI Guidelines** also state that all electrical outlets in patient rooms and patient toilet rooms be a hospital-grade, tamper-resistant type. Use of GFCI receptacles⁶¹⁰



is also preferred to reduce the risk of patients being able to harm themselves by tampering with the receptacles. Arc-fault devices are available and may be provided if required by the Safety Risk Assessment for the patient population being served.

- iii. Cover Plates - All electrical device cover plates (for switches, receptacles, blank cover plates, etc.) must be attached with tamper-resistant screws.⁴⁷⁰ Cover plates made of polycarbonate⁶¹² materials are preferred; polycarbonate cover plates must have screws in each corner to make them rigid enough to resist bending and protect patients from access to electrical wiring and contacts. Nylon cover plates and ones marketed as “unbreakable” are typically not sturdy enough to resist tampering by patients. Standard stainless-steel cover plates that fit tightly to the wall and are rigid may be acceptable for many patient populations if allowed by the Safety Risk Assessment. These may be secured with a single tamper-resistant screw in the center as long as it is securely tightened. The tightness of these screws and fit to the wall is suggested to be included in regular safety rounds documentation.



#612c



#620c

b. Light Fixtures:

- i. i. All fixtures that can be reached by patients are suggested to be a tamper-resistant type⁶²⁰ and have minimum ¼”-thick polycarbonate (clear or prismatic) lenses⁶³⁴ securely fixed in the frame with covers that are firmly secured with tamper-resistant screws⁴⁷⁰ and fit tightly to the ceiling surface. Many such fixtures are now available with LED light sources.
- ii. Advances in LED technology have resulted in new options for light fixture designs that can help reduce the institutional character of these spaces. The authors strongly encourage the use of these options and discourage the use of 2’x2’ and 2’x4’ light fixtures in all patient accessible locations. Our preference is for using linear, round or oval vandal-resistant fixtures for general illumination and recessed security downlights with polycarbonate lenses or small individual reading lights.



#624

- iii. The availability of tunable lighting (ability to adjust the color temperature of the light source) is encouraged as is the use of circadian lighting systems.
- iv. Glass components that could be accessed by patients are discouraged for use in any fixture. Use of table lamps or desk lamps are also strongly discouraged. Neither incandescent light bulbs nor fluorescent tubes should ever be accessible to patients.



#6250b

- c. Exit Signs - Lighted Exit Signs⁶⁴⁰ or Photo-luminescent Signs⁶⁴²** – These are suggested to be vandal-resistant and installed tight to the ceiling with a full-length mounting bracket to avoid use as a hanging device. Mounting these signs on a wall so they are perpendicular to the wall is not recommended because it leaves the top exposed as a possible attachment point.



#640a

9. Communications

- a. Telephone Sets** - Telephones located in corridors or common spaces for patient use should have a stainless-steel case,⁶⁴⁵ be securely mounted to the wall, and have a non-removable shielded cord of minimal length (as approved by the Safety Risk Assessment) with cable tether inside the shield. They may be equipped with or without touch pads for placing outbound calls. Some organizations have a switch installed in a staff area to deactivate patient use phones at times when patients are not allowed to make calls.



#645a

Some facilities are now providing cordless phones for patient use.

- b. Duress Alarms** – as many Patient to staff injuries are a significant concern in many facilities. One way to address this (other than designing the unit to eliminate locations where staff may become isolated with a patient and become trapped) is to provide some type of personal duress alarm system⁶⁵⁰ that staff members can wear and activate when needed. It is preferred that these systems provide information on the location of the staff member when the alert is sent. Some of these can interface with other systems that may already be present in the facility and even use existing wi-fi systems for connectivity.



#650f

10. Electronic Safety

- a. Metal Detectors** - Some organizations have expressed the desire to use metal detectors to assist with screening patients and/or visitors to their behavioral health facilities. Some choose to use hand-held detectors and others use standard walk-through detectors. Organizations considering metal detection solutions may want to investigate ferrous metal detection systems⁶⁶⁰ that sense the presence of ferrous metal in objects such as razor blades, syringes, lighters, cell phones, knives and guns. These systems will not detect drugs or other nonferrous metal contraband items.

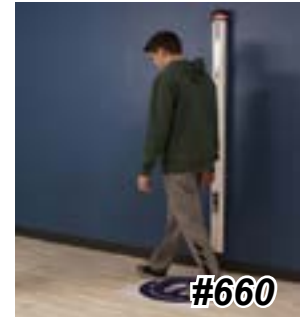

11. Exterior Improvements - Outdoor Areas

- a. Enclosed courtyards**, fenced areas adjacent to a treatment unit, or an open campus) are considered to have great therapeutic benefit. Because levels of staff supervision for patients using outdoor areas may vary widely between facilities, or even between different groups using the same space at different times, the need for supervision should be carefully reviewed by management early in a design and construction project. The final design for outdoor areas must respond to the acuity and assessment of the most acute patients using the area and the planned staffing levels for each patient population.
- b. Fencing** - Climbable fences can permit, if not encourage, unauthorized access to windows and roofs or elopement over walls. Buildings, walls, or fences may be used to establish clear boundaries and impede elopement to a degree appropriate to the patient population being served. Some behavioral health organizations are comfortable with a perimeter enclosure that is not particularly difficult to climb and simply make elopements a treatment issue if the patients return. Other organizations have a very high need to reduce elopements to the extent possible. Where this is the case, designers may tend to create enclosures that have a very prison-like appearance. If views to the distance are not required, one approach is to treat the outdoor areas as meditation gardens with solid masonry walls that have a smooth interior surface and are 12 to 14 feet high.
- i. One facility installed large diameter (22"-24") plastic pipe on top of the wall to make it difficult for patients to get a



grip on the top surface. This pipe can be painted to match the color scheme of the building and provides a much less institutional appearance than concertina wire. If views to the distance are desired, “windows” glazed with polycarbonate²⁰¹ or security glass²⁰⁰ may be provided in these walls. These view panels should not have sills or cross bars that could provide footholds for climbing.

- ii. Another option is installation of a fine mesh chain-link fence fabric.⁶⁷⁵ This fabric, which comes in a range of sizes down to as small as 3/8” openings, makes the fence more difficult to climb and has openings that are too small for most bolt cutters. When installing such material, fence posts and rails must be strong enough to support the fabric and the wind loading it will add. In at least one instance, a patient successfully climbed a mini-mesh fence, so it is suggested a section at the top be angled inward to further increase the difficulty of climbing at the cost of increasing institutional appearance.
- iii. Maximum security fencing,^{675b} which has a very prison-like appearance, may be selected for some facilities with involuntarily admitted patients. However, it is suggested that the use of less institutional-looking solutions be explored before deciding to use this type of material.
- iv. Where portions of the building walls will enclose exterior courtyards for patient use, these walls should not be easily climbable, especially if they are only one story high. Windowsills, rain gutters, and similar features may support efforts to climb walls to gain access to the roof. The exterior surface of all windows patients can access from exterior courtyards must have security glazing,²⁰⁰ polycarbonate glazing,²⁰¹ or security window film,¹⁹⁰ as described under Level II-D.



c. Outdoor Furniture - In all cases, careful consideration should be given to exterior furniture used by patients. All outdoor furniture⁵¹⁰ is suggested to be firmly anchored in place. This will resist the furniture from being moved to create barricades or stacked to allow climbing over fences,

into windows, or onto buildings. Many types of commercially available furniture can be anchored or are made of concrete or other heavy materials.

- d. Plant Materials** - Shrubbery should be non-toxic and low-growing. Avoid planting shrubbery close together as it can create visual barriers that patients or unauthorized visitors may hide behind. Landscape mulch or decorative rocks that can be thrown to injure staff or other patients should not be used. Trees should be located away from buildings, walls and fences to reduce ease of access to roofs or getting over fences.
- e. Area Drains and Manhole Covers** - All manhole covers, access panels, and area drain grates should be anchored firmly in place to discourage easy removal and use as weapons and to make it difficult for patients to enter the underground piping.
- f. Public Areas** - All areas surrounding patient use buildings, areas where staff will walk or escort patients at night, and courtyards should be well-lighted. Exterior lights should not shine directly into patient room windows. Parking areas for staff and visitors should be well-lighted and reviewed regularly for design features that encourage personal and property security. While security is generally beyond the intended scope of this document, closed-circuit television monitoring and video surveillance recording of these semi-public areas, where there is no expectation of privacy, should be considered.

B. Level I

Areas where patients are not allowed:

All items do NOT need to comply with Baseline conditions but are suggested to meet the following:

1. Comply with all applicable codes and regulations.
2. All service areas should be locked at all times to reduce the possibility of patients entering these spaces.
3. Hardware on doors that connect to a higher Level of Risk (accessible to patients) shall have hardware suitable for the higher level of risk.

C. Level II

Areas behind self-closing and self-locking doors where patients are highly supervised and NEVER left alone which could be counseling rooms, activity rooms, interview rooms, group rooms as well as corridors that do not contain objects that patients can use for climbing and where staff are regularly present:



Architect of Record - Davis Partnership, Denver,CO: Photographer - Paul Brokering Photography



This document is intended to represent leading current practices, in the opinion of the authors. It does not represent minimum acceptable conditions or establish a legal “standard of care” that facilities are required to follow.

All items same as Baseline with the following exceptions:

Our understanding of The Joint Commission’s recommendations at the time of this publication is that the conditions identified in the “Baseline Considerations for Patient Accessible Areas” above may be revised as stated below in Level II areas. It is strongly suggested that these revisions only be made after careful consideration and if these variations are consistent with the organization’s Safety Risk Assessment. The Safety Risk Assessment should identify all standard items that typically are not allowed on inpatient behavioral health units that are present in rooms that are defined as Level II in this document.

a. Doors - Barricading considerations discussed in Baseline section above are highly recommended for doors to all rooms that patients will enter.

b. Door Hardware:

- i. All unattended counseling rooms, interview rooms and other rooms patients may enter only when staff are present are suggested to have self-closing and self-locking doors.
- ii. These rooms are suggested to have “classroom” function locksets that require a key to lock or unlock the outer handle, but the inside handle is always free.

This feature will resist patients being able to lock or unlock doors. The alternative could be to provide “storeroom” function locksets with which the doors will always be locked from the outside when closed and latched. The inside lever will always be free.

- iii. Closers are needed for Level II rooms which TJC requires to have self-closing and self-locking doors and that staff must ALWAYS be present when patients are in the room. They may be required for other doors by building and life safety codes or because the staff want to assure that a particular door is not accidentally left open for operational reasons. Where provided, concealed closers^{100a} that have the closer and the track both completely contained in the head of the door and frame offer the least amount of ligature attachment opportunity (the arm is only exposed when the door is open). However, these require



special preparation of the door and frame and are difficult and expensive to provide in existing conditions. Where concealed closers are not practical, it is suggested that surface mounted track closers^{100b} be provided and located on the side of the door that either patients are not allowed (Level I spaces) or where the closers are most observable by staff.

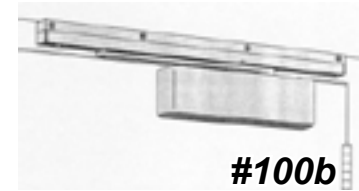

2. Finishes

- a. **Ceilings** – Our understanding of current TJC recommendations is that accessible lay-in type ceilings are acceptable in Level II spaces if that is consistent with the organization’s Safety Risk Assessment.
- b. **Wall Base** – Standard surface applied thin vinyl or rubber base may be acceptable if that is consistent with the organization’s Safety Risk Assessment.

3. Specialties

- a. **Kitchen Equipment:** (Same as Level III except may not need to be lockable if acceptable under the Safety Risk Assessment.)

4. Furnishings

The use of furniture that is lighter weight, easily movable and that has obvious opportunities for ligature attachment in Level II rooms may be acceptable to TJC and can be considered for use if it complies with the findings of the Safety Risk Assessment performed by the organization.

The health care organization should select furniture appropriate for the patient population served and the location on the unit for which it is intended. Care should be taken to realize that it is not uncommon for unauthorized movement of furniture from a low-level risk area to a higher risk area of a unit to occur. This may result in unintended risks being created.

- a. **Seating** - Open arms and legs on un-weighted furniture that is not securely fixed in position may be acceptable if consistent with the Safety Risk Assessment. High-quality wood, steel or plastic chairs for use at tables may be more standard products. Upholstered lounge chairs⁴⁸² that resemble typical residential furniture are generally preferred.



- b. **Tables** may be more typical style, have individual legs at the corners and be easily movable to accommodate a range of uses and activities.
- c. **Bookcases and Cabinets** - Same as Baseline except as may be allowed by SRA for areas behind self-closing and self-locking doors as discussed above.



6. Plumbing Fixtures and Fittings

- a. **Toilet Fixtures** - Level IV and V areas only
- b. **Sinks** – Standard stainless-steel sinks may be permitted if that is consistent with the organization’s Safety Risk Assessment, but caution is recommended.
- c. **Showers** - Level IV and V areas only
- d. **Faucets** - Standard goose-neck faucets and standard valve handles may be permitted in activity and similar areas that are consistent with the organization’s Safety Risk Assessment, but caution is recommended.
- e. **Flush Valves** - Level IV and V areas only
- f. **Medical Gases** - Not typically present in Level II areas

7. HVAC:

- a. **Diffusers, Registers and Grilles** – Standard products may be acceptable if that is consistent with the organization’s Safety Risk Assessment. Products consistent with Level III suggestions are recommended.
- b. **Thermostats** – Standard products may be acceptable if that is consistent with the organization’s Safety Risk Assessment. Products consistent with Level III suggestions are recommended.

8. Electrical

- a. **Electrical Devices:** Standard products of this type may be acceptable if that is consistent with the organization’s Safety Risk Assessment.
- b. **Light Fixtures** –

- i. Standard products may be acceptable if that is consistent with the organization's Safety Risk Assessment. Products consistent with Level III suggestions are recommended.
 - ii. Covers⁶³⁰ are available for existing (or new) downlights that are secure and make the appearance more residential in nature.
 - iii. No glass components should be exposed to patients in any fixture and use of table lamps and desk lamps is strongly discouraged.
- c. Exit Signs** - Standard products may be acceptable if that is consistent with the organization's Safety Risk Assessment. Products consistent with Level III suggestions are recommended.
- d. Security Lighting** - Standard products may be acceptable if that is consistent with the organization's Safety Risk Assessment. Products consistent with Level III suggestions are recommended.



D. Level III

Areas that are not behind self-closing and self-locking doors where patients may spend time with minimal supervision such as open lounges, day-rooms and corridors where staff are not regularly present. Open nurse stations are suggested to be considered under this Level because there may be incidents where staff will not always be present in these spaces:



Architect of record: Progressive AE, Grand Rapids, MI - Photographer: JRP Studios



West Springs Hospital - Day Room

Architect of Record - Davis Partnership, Denver, CO: Photographer - Paul Brokering Photography



Kingsbrook JMC - Dining Room

Architect of Record: Bernstein & Associates, Architects, New York, NY - Photographer: Paul Warchol

This document is intended to represent leading current practices, in the opinion of the authors. It does not represent minimum acceptable conditions or establish a legal "standard of care" that facilities are required to follow.

Level III

All items shall be the same as Baseline with the following exceptions:

3. Specialties

a. Kitchen Equipment: (Typically Levels II and III only) -

All cooking appliances (ranges, microwaves, coffee makers, etc.) should have key-operated lockout switches⁶¹¹ to disable the appliance. If these and other appliances, such as refrigerators, have open handles that could be used as ligature attachment points, and they are in areas where patients have unsupervised access to them, provisions should be made to close them off with overhead coiling doors or other means.

- i. Patient access to coffee should be carefully considered in each facility's risk management program. If access to this (and other potentially scalding liquids) is allowed, an insulated plastic dispenser should be located so it is readily observable by staff. Glass coffee pots should never be available to patients.
- ii. All garbage disposal units should have a key-operated lockout switch⁶¹¹ to disable the device.
- iii. All receptacles located near sources of water, including sinks, as well as all patient-accessible receptacles must be GFCI-protected as required by applicable codes.



#611

b. Television Set Enclosures (Typically Levels II and III only) -

Television sets should not be mounted on walls using exposed brackets because of the ligature risk this presents. Rather, all TV sets should be installed in built-in TV or media centers or manufactured tamper-resistant covers with sloped tops.²⁹⁰ Some facilities prefer to also have an isolation switch that staff can control. For maximum safety, the electrical outlet and cable TV outlet should be located inside the cover to keep the wires and cables away from patients.



#290a

4. Furnishings

The health care organization should select furniture appropriate for the patient population served and the location on the unit for which it is intended. Care should be taken to realize that it is not uncommon for unauthorized movement of furniture from a low-level risk area to a higher risk area of a unit to occur. This may result in unintended risks being created.

a. Seating - Closed arms and legs on furniture that is weighted or is securely fixed in position may be preferred when consistent with the Safety Risk Assessment. High quality plastic chairs for use at tables may be acceptable. Lounge chairs with upholstery⁴⁸² that resemble typical residential furniture and meet the criteria above are generally preferred.



b. Tables⁴⁸⁵ are suggested to not have individual legs at the corners and be weighted or anchored in place to resist being thrown or stacked.



c. Bookcases and Cabinets - Same as Baseline.6.

a. Toilet Fixtures - Not permitted in Level III areas

b. Sinks – Standard stainless-steel sinks may be permitted if that is consistent with the organization's Safety Risk Assessment, but caution is recommended.

c. Showers - Level IV and V only

d. Faucets - Standard gooseneck faucets and standard valve handles may be permitted if that is consistent with the organization's Safety Risk Assessment, but caution is recommended. In Level III areas consideration is suggested to locating these sinks behind lockable doors or roll-down shutters that are closed and secured when staff are not present.



e. Flush Valves - Level IV and V only

f. Medical Gases - Level IV and V only

g. Diffusers, Registers and Grilles - Standard grilles are not recommended in Level III areas. Grilles with "S" shaped vanes are preferred.

E. Level IV

**Areas where patients spend a great deal of time
alone with minimal or no supervision:**

Level IV-a. Patient Rooms



Institute for Patient Centered Design - Patient Room Mock-up

Architect winning design competition: HDR, Omaha, NE - Photographer: VA Photo, Scott R. Snell

All items shall be the same as Baseline with the following exceptions:

1. Openings

a. Doors:

- i. Patient Room doors continue to be one of the most frequently used items in suicide attempts in these facilities. This is verified in **TJC's** "Incidence and Method of Suicide" study dated July 2018.

Barricade resistant strategies discussed in the Baseline section are strongly suggested to be used in these locations.

This document is intended to represent leading current practices, in the opinion of the authors. It does not represent minimum acceptable conditions or establish a legal "standard of care" that facilities are required to follow.

- ii. These doors also frequently receive abuse and use of the more durable synthetic faced doors²⁵ in these locations will help retain their appearance.

b. Door Hardware:

- i. The handles on locksets are especially important on these doors. Careful consideration of the risks involved in compliance with the Safety Risk Assessment is strongly suggested.
- ii. Hinges need to be carefully coordinated with the barricade resistant solution selected and over-door-alarm system, if provided. These need to be thought of as an assembly, not separate parts that can be put together in any combination.
- iii. Over-the-door alarms¹⁵⁰ are strongly suggested for patient room to corridor doors. Since the building and life safety codes require these doors to be tight-fitting for smoke and other reasons, the top of these doors is one of the attachment points most frequently used in suicide attempts. The bottom of doors can also present a risk if the gator roll technique is attempted. One product will detect this also.
- iv. Some facilities have begun to address the desire of some patients to lock themselves in their rooms to avoid unwanted entrance by other patients. The challenges with this are to provide individual security for the patient without restricting staff access to the room. Options include locksets with specialized locking functions and ligature-resistant turnpieces¹⁴⁰ that cannot be held from inside the door to resist a key being turned to unlock the door. A cylinder protector¹⁴¹ to cover the lock cylinder on the corridor side of the door resists attempts to insert objects in the key-way. Card access technology is also available to control these locks.

- c. **Windows:** – Advances in different types of safety glass make it worthwhile to consult an expert for advice for a specific project. The height above the ground, patient population, and many other factors should be taken into account in choosing these materials. Comply with the FGI



Guidelines and all applicable codes and regulations for glazing, frame installation and operable sash.

If replacing windows presents a prohibitive cost in remodeling work, a security screen with a very sturdy steel frame⁸⁰ designed to resist deflection and equipped with multiple key locks and a heavy-gauge stainless steel screen fabric⁸¹ may be used. These are functional and secure but create an “institutional” appearance and can be defaced by writing obscene words with toothpaste (or other material). Patients have also been known to use the rough surface of the screen fabric to abrade their skin

- i. Exterior Windows - Mini- blinds⁴³⁰ or roller blinds⁴⁴⁰ behind safety glazing is strongly suggested for these rooms. Ligature resistant control of the blinds can either be by staff only or by both patients and staff as indicated by the Safety Risk Assessment.
- ii. Interior Windows – The provision of view windows between patient rooms and corridors is usually discouraged for patient privacy reasons. The use of windows (either in doors or walls) as a method of performing routine patient checks at night is discouraged because it is often very difficult to observe the patient sufficiently. If these windows are provided, it is strongly suggested that they have either mini-blinds²²⁰ between Security glass or glass that can be made opaque electrically.²²¹ Either type of control is preferred to be by staff only to restrict patients’ ability to peek in on other patients.
- iii. Operable Windows – These are not usually required in patient rooms but may be provided if desired by using products that reduce the risk of elopement and passing of contraband⁴³⁴ (if on the ground floor).

d. Glazing – Security glazing²⁰⁰ is strongly suggested for these rooms.

e. Window Coverings – See Baseline

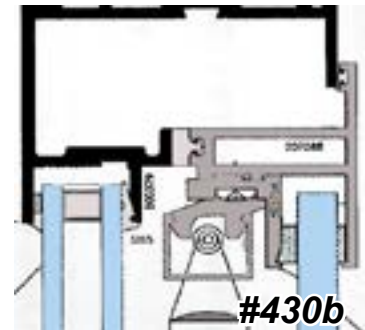

2. Finishes

- a. Walls** – Impact and/or abrasion-resistant gypsum board²³⁰ installed on minimum 20-gauge metal studs spaced no more than 16 inches on center; paint finish preferred. Sound-attenuating gypsum board²³² may also be used on walls if approved by the manufacturer for use in behavioral health applications.
- b. Ceilings** – *TheFGI Guidelines* currently require “monolithic” ceilings in all patient bedrooms, Bathrooms, bathing facilities and seclusion rooms. Their definition of this term virtually requires the use of solid gypsum board^{230, 232} ceilings. These are suggested to have key-lockable access panels³⁰ that fit tightly to their frames. Larger sizes of these panels, may require tamper-resistant screws in the corners or along the sides of the panels. Pick-resistant caulk may be needed if the flanges of these panels do not fit tightly to the ceiling or wall surface.



Other tamper-resistant systems²³⁹ discussed in Baseline section do not appear to meet this definition.

- c. Wall Base** - See Baseline
- d. Flooring** – See Baseline: If some patients are prone to urinate on the floor, provide some rooms with seamless epoxy²⁵⁰ or sheet vinyl flooring with an integral cove base. Metal or plastic strips should not be applied at the top edge of the base. Use of a system that eliminates the need for trim strips^{250c} is recommended.
- e. Special Wall Surfacing** – Wall protection panels³²⁰ are sometimes used in these areas, but the use of plastic or metal trim strips are strongly discouraged.

3. Specialties

- a. Cubicle Curtains and Tracks** – These are not recommended for use in behavioral health facilities because of the risk they present. If non-ambulatory patients with co-existing medical conditions are being treated on these units, it is recommended they be assigned to single-patient rooms.

4. Furnishings

a. Seating:

- i. Desk chairs are preferred to be lightweight⁴⁸¹ or ballasted⁴⁸⁰ as discussed in Baseline Considerations.
- ii. Stools⁴⁷⁹ that are specially designed for use in behavioral health units are also available.



b. Furniture:

- i. **Sturdy wood, thermoplastic, or composite furniture should be bolted to the floor or walls whenever possible.** Care must be taken to assure the furniture will withstand abuse, will not provide opportunities for hiding contraband, does not have joints that will allow penetration of liquids such as urine, and will resist being disassembled to provide patients with weapons.

Open-front units with fixed shelves and no doors or drawers⁴⁹⁵ are recommended. Doors should not be provided because they can be used by patients as ligature attachment points. Drawers should not be provided because they can be removed by patients and broken to use as weapons. All upholstery and foam used in furniture and mattresses should have flame-spread ratings that comply with the requirements of NFPA 101: *Life Safety Code*, Section 10.3.

ii. Beds

- **Non-Adjustable Platform Beds⁴⁹³** – Beds without wire springs or storage drawers are preferred. These beds should be securely anchored in place to prevent patients from using them to barricade the door. If a portable lifting device will be used, beds are available with an opening underneath to accommodate the legs of the lift.⁴⁹⁴ Portable lifts can also be accommodated by placing an existing platform bed on a specially designed riser; this arrangement also reduces the amount of bending over staff need to do to work with the patient.^{494b}



- **Mattresses for Platform Beds**⁴⁹² – These should be specifically designed for use in behavioral health facilities and be resistant to abuse and contamination.
- **Bedding**⁴⁹¹ - If bedding other than standard sheets are indicated by the Safety Risk Assessment for some patients, one piece durable products are available,
- **Electric Hospital Beds** – If electrically operable beds are needed for patients with co-existing medical issues or to reduce risk of staff injuries, beds that are specifically marketed for use on behavioral health units⁴⁹⁰ should be used rather than standard electrically adjustable hospital beds. These specialty beds will sense obstructions and reverse direction and have lockout features for the controls, reduced-length cords, and other tamper-resistant features. However, they do have significant ligature attachment point risks with the guard rails, headboard, foot board and allow access to many hazards beneath the bed.
- If existing electrically operable beds must be used for financial reasons, use only beds that require a constant pressure on a switch located on the bed rail (not a remote-control device or paddle that can be placed on the floor). Also, provide a key lockout switch⁶¹¹ on the beds (or a removable pigtail) so only staff can operate the beds. All electrical cords should be secured and shortened. These beds also have significant ligature attachment risks as mentioned above.
- As for other wheeled beds, the wheels of electric hospital-type beds should be removed or rendered inoperable. It is further suggested that corridor doors to rooms with electrically operable beds be locked at all time the patient is not in the room to reduce the risk of other patients entering the room and harming themselves.



#492e



#491a



#490d



#496

- iii. **Wardrobes** – Wardrobe units should not have doors and should have fixed (non-adjustable) shelves.⁴⁹⁶ They should be securely anchored in place and have sloped tops. Wardrobes with clothes poles requiring hangers are discouraged because, although the bar can

be made safe, the hangers present serious hazards.

The **FGI Guidelines** no longer call for patient rooms to have accommodations for “hanging full-length clothing.” The average length of stay in many facilities is now in the 7-to-10-day range, and patients seldom come with clothing that needs to be hung up. The use of clothes hangers is not recommended.

- iv. **Cabinets (Built-in)** – if provided, these are strongly suggested to have no doors or drawers and any shelves be securely anchored in place to resist both upward and downward force.
- One exception to not having cabinet doors may be cabinets to hold CPAP machines^{496c} in some patient rooms if allowable by the facility’s Safety Risk Assessment. These have a slot to allow the tubing to exit the cabinet. Care is suggested in locating these and consideration of other patients who may have access to the tubing. It is suggested that if these are provided they be equipped with concealed hinges, key operated locks, ligature resistant pulls and be designed so the doors resist ligature attachment when closed and locked.



496c

6. Plumbing Fixtures and Fittings

- a. **Toilet Fixtures** - Levels IVb and Vb only
- b. **Sinks** – Hand washing sinks are not required in Psychiatric Hospital patient rooms by the FGI Guidelines but toilet rooms are required to have sinks by the FGI Guidelines and are covered in Level IVb.
- c. **Showers** - Levels IVb and V only
- d. **Faucets** - Levels IVb and V only
- e. **Flush Valves** - Levels IVb and V only
- f. **Water Stations** – Levels II and III only
- g. **Medical Gases** – These are not normally required for behavioral health units. If there is medical necessity or the outlets are a preexisting condition in remodeling projects, they are suggested to be covered with lockable panels^{590c} as listed in Baseline above or panels attached with tamper-resistant screws. These covers should be removed or



#590c

opened only to address the medical needs of the current patient and replaced when that patient is discharged or moved. Special care must be taken in semi-private rooms to assure that access to the medical gases does not present a safety risk to the other patient. Some manufacturers offer lockable covers for outlets. Cabinets that are large enough to enclose the devices attached to the outlets^{590b} are preferred.



7. HVAC

a. Diffusers, Registers and Grilles:

- i. Fully recessed vandal-resistant grilles with S-shaped air passageways⁶⁰⁰ are recommended for all ceiling and wall-mounted grilles. Perforated air grilles are not suggested for Level IV areas.
- ii. In new construction or major remodeling projects, locate individual room HVAC equipment (such as fan/coil units) in an adjacent corridor or another location (e.g., an interstitial space) where they can be serviced without entering the patient room.
- iii. If individual fan/coil-type units exist and must remain, they should be protected with vandal-resistant covers⁶⁰⁶ the same as for corridors in all other Levels.

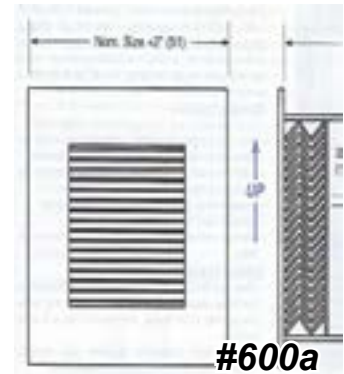

b. Thermostats – See Baseline and as called for in the Safety Risk Assessment.

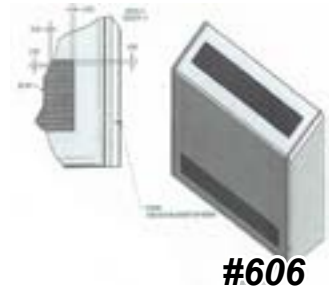

8. Electrical

a. Electrical Devices:

- i. In new construction or major remodeling, the **FGI Guidelines** require a dedicated circuit be provided for all electrical outlets in each patient room and bath. This will allow power to the outlets in a specific room to be turned off if necessary for a patient's safety. Control of each circuit should be located where only staff have access. Where this is not practical in an existing facility, a tamper-resistant temporary cover may be installed when necessary.

- ii. All electrical switch and outlet cover plates should be as discussed in Section A - Baseline Conditions.

b. Light Fixtures –

- i. The standard general hospital practice of providing a 2'x4' light fixture directly over patient beds is seldom needed in behavioral health facilities because medical treatment is not provided in the patient beds and looking up into one is not very pleasant.

The traditional placement of one of these directly over the bed is a carryover from general hospital design that is seldom needed in behavioral health facilities.

- ii. The current preference is for using either wall or ceiling mounted narrow strip LED fixtures.^{620d} An alternative can be round or oval vandal-resistant fixtures^{620k} for general illumination. Many of these fixtures are now available with LED light sources and some are tunable to allow patients or staff to change the color or the light.
- iii. Any downlights are suggested to have polycarbonate lenses.^{620h}
- iv. Small individual reading lights⁶²⁴ can be provided to give reading light near beds or adjacent to built-in bench seating areas or allow patients to turn on a small light to assist when getting up in the middle of the night.
- v. Night Lights⁵³⁹ – are required by the **FGI Guidelines** in patient rooms and these are to be controlled from a location near the door to the room.



9. Communications

- a. **Telephone Sets** are not typically provided in behavioral health patient rooms.
- b. **Nurse Calls** are not required in behavioral health patient rooms by the FGI Guidelines; but, if they are provided, they are required to meet their standards and are suggested to have flush mounted push button activation.⁶⁵³

If cords are provided, it is recommended they be no longer than 6" and as lightweight as possible.

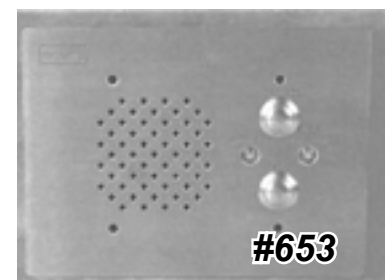

Level IV-b. En-suite Patient Toilet Rooms:



#113c



#150a

All items shall be the same as Baseline with the following exceptions:

1. Openings

a. Doors & Hardware - The first question to address for patient toilet room doors is whether the facility ever has the need/desire to lock patients out of their bathrooms.

i. If there is a need to lock patients out of the bathroom:

- A full-size, tight fitting, out-swinging door mounted on a double-acting continuous hinge^{113c} with cap and over-door alarm¹⁵⁰ is preferred. Also, a classroom function deadbolt that extends the bolt into the head of the door frame (with a ligature-resistant turn piece on the inside that will retract the bolt but not extend it^{143b}), two flush pulls¹²¹ mounted back to back (larger pulls^{121d} available for ADA accessible rooms), and a roller,¹⁴⁷ ball¹⁴⁶ or magnetic¹⁴⁸ latch at the head should be installed along with a rubber fin with top fixing bracket^{473e} mounted on the strike side of the frame.

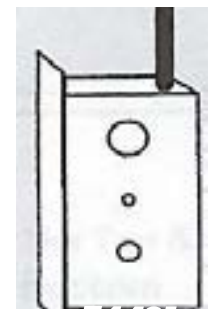

#143b



#473e

This document is intended to represent leading current practices, in the opinion of the authors. It does not represent minimum acceptable conditions or establish a legal "standard of care" that facilities are required to follow.

- A sliding door^{40g} that is ligature resistant can eliminate issues with swinging door conflicts or floor space issues as long as there is wall surface for it to slide over in the open position. Ligature resistant pulls and locking hardware are available for this configuration. A frame assembly is now available for this system to assist with installation on existing openings.
- ii. If it is not necessary to lock patients out of their bathrooms, one of the following options may be provided:
- Non-lockable doors eliminate many of the hanging hazards associated with a typical door. Some attach with magnets^{470a} and may be easily removed by staff for use as a shield against an attacking patient.
 - Door assemblies with sloped tops^{473c}, continuous hinges and rubber fins at the strike jamb and ligature resistant pulls are another option.
 - No Door - Some facilities with single-patient rooms are electing to remove doors entirely from patient toilet rooms. The practicality of this depends on not having a clear sight line into the toilet room from the corridor door. This has proven to be unpopular with patients in some facilities due to the lack of privacy.
- iii. Shower Openings - Doors – No shower curtains or their tracks of any type (including those designated as “breakaway” and represented by their manufacturers as “safe for psychiatric hospitals”) are recommended for use in any patient-accessible areas, especially patient showers. In new construction, showers could be designed to contain the spray within the compartment without the use of a curtain or door. The use of foam doors^{473b} or hard plastic doors^{473c} mounted with a minimal gap between the bottom of the door and the floor may be used to reduce the amount of water that leaves the shower compartment.



#40g



#470a

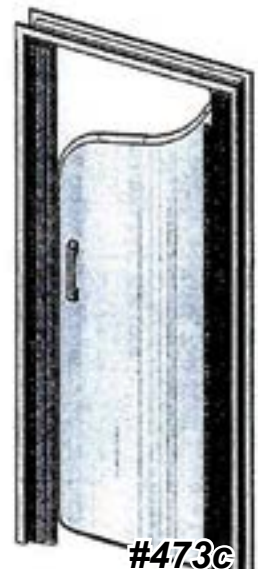

#473c

The use of residential glass shower doors is specifically discouraged.

This document is intended to represent leading current practices, in the opinion of the authors. It does not represent minimum acceptable conditions or establish a legal “standard of care” that facilities are required to follow.

2. Finishes

- a. Walls** – Use one of the following depending on the acuity of the patient population and the project budget:
- Synthetic wall protection panels³³¹ (without trim pieces) or solid-surface sheet material
 - Ceramic or porcelain tile in large pieces
 - Gypsum board that is impact-resistant and has mold and moisture-resistant facing²³⁰ with epoxy paint; solid-surface sheets in showers
- b. Ceiling** – Gypsum board with mold- and moisture-resistant facing²³⁰ with epoxy paint is recommended.
- c. Wall Base** – See Baseline
- d. Flooring** – One of the following may be used depending on the acuity of the patient population and the Safety Risk Assessment :
- Seamless Epoxy Flooring²⁵⁰ – This flooring should have a slip-resistant finish and integral cove base and can be used in a shower. Do not use a metal or plastic strip at the top of the base as patients can remove it for use as a weapon.
 - Ceramic and Porcelain Tile - Larger tiles may be used (to reduce the number of joints) as long as the installation is maintained in good condition.
 - One-Piece Floor Units – These units⁵⁶⁴ provide a monolithic floor (European-style) for the entire patient toilet room that drains the shower to a central location. If used in conjunction with location of the shower enclosure and shower head, this unit can eliminate the need for shower curtains.
 - Solid-Surface Material Basins – These are available with a trench drain⁵⁶⁷ across the entire front opening of the stall, which not only helps keep water from getting into the room, but also makes the drain more difficult for patients to intentionally clog. Fiberglass shower stalls and floors are generally not durable enough.

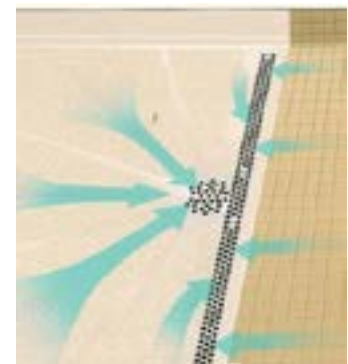
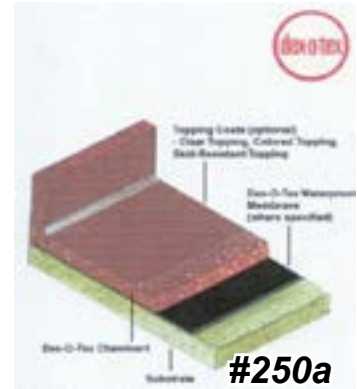

- v. Prefabricated Bathrooms⁵⁶⁸ – These contain all finishes, fixtures, and accessories and can reduce construction time because they are shipped to the site ready to be connected to the utilities.



3. Specialties

a. Toilet Accessories –

- i. Robe Hooks – Evaluate the risk of using these hooks. If they are required, they should be the collapsible type.³⁵⁰
- ii. Towel Bars – Use collapsible hooks³⁵⁰ instead of towel bars for towels.
- iii. Grab Bars – Because some patients may be on medications that interfere with their equilibrium, grab bars for toilets and showers are recommended for all patient-accessible toilets. A self-draining bar³³² may be installed on a slight slope. These provide a high degree of safety and are also easy to clean and sanitize. If the wall surface behind the bar is not smooth and flat, provide pick-resistant sealant to the joint between the bar and the wall.
- iv. Vertical Grab Bars – In locations where vertical grab bars are required or desired, typical ligature-resistant bars mounted vertically can usually be grasped only from one side. A ligature-resistant grab bar specifically designed to be mounted vertically³³⁷ can be grasped from either side.
- v. Soap Dishes These should not have handles and should be recessed. Soap dishes that can be installed from the front ^{390a} should be provided unless there is access to the chase behind the wall for installation
- vi. Soap Dispensers – Many facilities now use liquid or foam soap in patient areas, but the commonly used hard-plastic soap dispensers are problematic in that they are fairly easy to pull off the wall and break into sharp shards that can be used as weapons. At least one manufacturer now offers steel covers for their standard dispensers. Another solution is a dispenser made of solid-surface material³⁹¹ commonly used for counter tops that is relatively tamper-resistant. Some commercially available stainless steel dispensers are reasonably ligature-resistant.



#350e



#332b



#337



#390a



#391b

vii. Toilet Paper Holders:

- Toilet paper holders⁴⁰⁰ that do not require a bar or tube to hold the paper allow for standard use of the roll of toilet paper without requiring everyone using the roll to handle it. They are available in recessed and surface mounted styles and some have no moving parts.
- b. Other toilet paper holders use a bar(s) that pivot down^{400f.g} when vertical pressure is imposed.

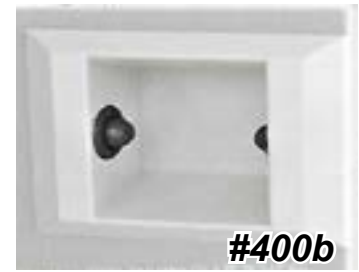

viii. Shelves – Shelves to hold miscellaneous items are often requested in shower stalls and near wall-hung lavatories. A stainless-steel suicide-resistant shelf that is either surface-mounted³⁷¹ or recessed into the wall³⁷⁰ may be considered for these applications. Front mounted recessed units are preferred unless access to the chase is provided.



ix. Paper Towel Dispensers – Paper towel dispensers are a concern in patient-accessible toilets because they typically are constructed of light-weight materials that can either be broken or bent to form sharp objects that may be used as weapons. Alternatives are as follows:

- Place a small stack of paper towels on a surface-mounted or recessed shelf.
- Provide a heavy-gauge, vandal-resistant dispenser.^{340b}
- Install a heavy-duty secure cover^{340a} over a standard-weight paper towel dispenser.



b. Mirrors and Domes – There are several options now available.

- i. Glass-laminated polycarbonate mirrors in ligature resistant wood frames offer an option with a residential appearance and are scratch resistant. (See also A.3.e.i)
- ii. Polycarbonate mirrors with built-in lighting are attractive and non-institutional but are susceptible to scratching.
- iii. Typical radiused stainless steel-framed security mirrors³⁶⁰ are available with polycarbonate, tempered glass, stainless steel, or chrome-plated steel reflective surfaces. Each has different durability and distortion characteristics. Some framed mirrors have a flat surface on top and/or do not fit tightly to the wall and ceiling.



6. Plumbing Fixtures and Fittings

a. Toilet Fixtures - Toilets used by behavioral health patients should be a floor-mounted, back (or wall) outlet, back water supply type rather than a wall-mounted fixture, which can be broken off its hangers. Currently, the only china fixtures in this configuration are ADA handicapped-accessible fixtures.⁵³¹ Where wall-hung toilets or floor mounted fixtures that do not fit tightly to the wall exist and replacing them is not practical, some facilities have had stainless steel or solid surface filler panels custom fabricated to fill the voids.

- i. Movable seats provide attachment points for ligatures, so their use should be considered carefully by each hospital. The solution is to use a fixture with an integral seat as suggested above. Some facilities feel this is too prison-like and choose to accept the risk of the movable seat.
- ii. China fixtures themselves (both floor- and wall-mounted) can be broken into large, sharp shards. Toilet fixtures made of solid-surface material⁵³³ and stainless steel⁵³⁴ are available and are much more resistant to breakage. The stainless steel fixtures can be powder-coated for a less “institutional” appearance.
- iii. Toilet fixtures that manufacturers claim will support loads in excess of 2,000 pounds are available if needed for patients of size.⁵³⁶



#531a



#534b



#533



#536

b. Sinks:

- i. Typical commercial solid-surface counter tops with integral sinks offer a much less institutional appearance. They also provide a place for patients to set their toothbrushes, etc. Specialty vanity top-type lavatories⁵⁴² provide many of the same benefits.
- ii. Wall-Hung Solid-Surface Lavatories – Corner lavatories⁵⁴⁰ make ligature attachment difficult and some come with the ADA required 18” space from the wall to the centerline of the drain and matching pipe enclosure.
- iii. If a wall-hung fixture is used that does not fit into a corner,⁵⁴¹ the optional filler panel is recommended to fill the space between the side of the fixture and an adjacent wall when there is one near the fixture. Stainless steel or high-impact polymer pipe covers designed for the lavatories that fit tightly to the bottom of the fixture should also be provided.
- iv. Lavatory Waste and Supply Piping – All piping of this type must be enclosed so it is not accessible to patients.⁴¹⁰ Extreme care should be taken to trim the enclosing material so it fits tightly to the underside of the lavatory fixture to prevent the patient from using this space to hide contraband.



#540a



#541a



#410a

c. Showers:

- i. Shower Heads – These should be a ligature-resistant institutional type.⁵⁵⁰ ADA Handicapped-accessible showers are required to have either a hand-held shower head or a second, lower head 48” above the floor. The hand-held shower head should be on a ligature-resistant, quick-disconnect fitting^{563b} that allows removal of the head and attached hose when not in use. If a hook is provided to hold the hand-held shower head, it should be mounted on the part of the fitting that is removed when the hose is removed. A ligature resistant shower head with integral quick-disconnect fitting and internal diverter valve^{553a} is available which reduces the clutter of individual items. Another option is to provide a lockable cabinet to house the hand-held head and valve.⁵⁶²



#563a

- ii. Shower Control Valves - *Note:* Provide thermostatically limited hot water to prevent accidental or intentional scalding in all patient-accessible sinks and showers.
- Single-knob mixing valves that provide minimal opportunity for tying anything around them are preferred.⁵⁵² These give patients control of the water temperature and duration of flow. Some of these are claimed to be ADA-compliant by their manufacturers.
 - If it is only necessary to replace the valve handles and the valve itself is working properly, use of a replacement valve handle^{552c} that can be adapted to a variety of valves might be considered. *Note:* This may void any remaining warranty on the existing valve.
 - A “no-touch” valve^{552e} that appears to be ADA compliant is available. It utilizes infrared controls to give patients control of a range of water temperatures and the duration of flow.
 - One-piece shower assemblies that contain shower heads, valves, and a recessed soap dishes⁵⁶⁰ work well for remodeling projects because they reduce the amount of repair needed for wall finishes. These are also available with a second head^{563c} located 48” above the floor and a diverter valve if needed for ADA purposes.
- iii. Shower Drains – That offer less opportunity for ligature attachment or patients abrading their skin⁵⁶⁵ are preferred over more traditional drain grates.
- iv. Diverter Valve – If a diverter valve is needed to change the water flow from the standard shower head to the ADA-required head, a ligature-resistant diverter valve⁵⁵⁵ may be provided.

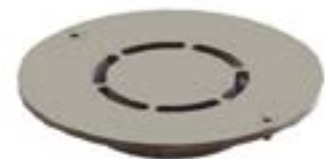

- d. Faucets - Lavatory and Sink Faucets and Valves –** Faucets and valves can provide attachment points for ligatures. A lavatory valve unit is now available that uses a shower valve fitted with a ligature-resistant handle⁵⁷⁴ to allow patients to control the temperature (thermostatically limited to prevent scalding) and duration of the water flow. This valve can be used to replace the motion sensor activation of some faucets. Faucets are available in a variety of materials

and configurations that range from push-button to motion sensor-activated.⁵⁷⁰ Faucets with two push buttons allow patients some choice of water temperature and do not require electricity (either battery or line voltage) to operate. They also will not automatically turn on unexpectedly, which is disturbing to some patients.

- e. Flush Valves** – Toilet flush valves that are recessed in the wall⁵⁸⁰ and activated by a push button⁵⁸¹ are preferred. Where this is not practical, the flush valve and all related pipes should be enclosed with a stainless steel⁵⁸⁵ or plastic^{585b} cover with a sloped top that incorporates a push-button activator for the valve. Sensor activation of flush valves is discouraged because they require electricity (either battery or line voltage) and may flush unexpectedly which can be disturbing to some patients.



#570



#581b

7. HVAC

- a. Air Grilles** – Perforated air grilles are not suggested for Level IV areas. Grilles with “S” vanes are preferred. See Section A Baseline Conditions.

8. Electrical

a. Electrical Devices:

- i. In new construction or major remodeling, the **FGI Guidelines** require a dedicated circuit be provided for all electrical outlets in each patient room and bath. This will allow power to the outlets in a specific room to be turned off if necessary for a patient’s safety. Control of each circuit should be located where only staff have access. Where this is not practical in an existing facility, a tamper-resistant temporary cover may be installed when necessary.
- ii. All electrical switch and outlet cover plates should be as discussed in Baseline.



#585a

- b. Light Fixtures** – These fixtures require wet condition rating and are otherwise the same as Baseline.

9. Communications

- a. **Nurse Calls** – These are not required by the **FGI Guidelines**, but if they are provided, they must meet general hospital standards. In addition, flush mounted push-button activation is preferred.⁶⁵³ In areas where falls may occur, it is recommended that a second push button located about 12” above the floor be provided below the one at normal mounting height. If pull cord activators are provided, the **FGI Guidelines** limit their length to a maximum of 6 inches in length.

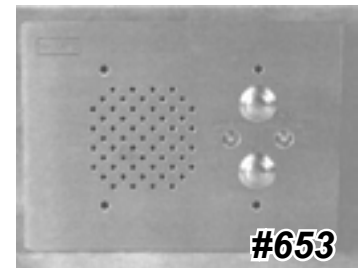

F. Level V:

Areas where staff interact with newly admitted patients who present potential unknown risks or where patients may be in highly agitated condition:

Level V-a. Admissions:

Architect of Record - Davis Partnership, Denver, CO: Photographer - Paul Brokering
Photography

All items shall be the same as Level IV with the following exceptions:

If possible, the admissions function is preferred to not take place on an inpatient unit. At admission, unit staff members know very little about a new patient and his or her trigger points. A separate location for admission avoids disrupting either the unit or the new patient due to the agitation of either.

The Admission rooms should be pleasant and welcoming and should be minimally furnished (with a few loose pieces of furniture).

The room should be large enough to allow for several staff to physically manage the patient if necessary. If possible, the admitting staff member should not be in the room alone with a patient. After the admitting process is complete, the patient can be escorted to the unit. These precautions are particularly important

This document is intended to represent leading current practices, in the opinion of the authors. It does not represent minimum acceptable conditions or establish a legal "standard of care" that facilities are required to follow.

for emergency admissions, which frequently occur at night and on weekends.

1. Openings

a. Doors - As stated above, all rooms patients will enter are suggested to have a barricade-resistant solution as discussed in Baseline.

b. Windows:

- i. Exterior – If exterior windows are present, they are suggested to comply with comments for Level IV above.
- ii. Interior - Provide a small (12”x12” or 4”x24”) view window in the door that can be controlled by staff²²⁰ from outside the room to observe what is happening in the room when necessary and resist non-authorized individuals having visual access to the room.



4. Furnishings

a. Cabinets (Built-in) - Same as discussed in Baseline.

b. Seating –

- i. The furniture arrangement is suggested to locate the patient’s and family member’s chair(s) so that when they are seated, they will not be between the staff member and the door to the room.

Chairs⁴⁸² are preferred to be comfortable and fixed in place or heavyweight as discussed in Section A Baseline Concepts.

- ii. Desk Seating for staff⁴⁸⁰ is suggested to be a lightweight plastic chair in lieu of a standard desk chair which could be used as a weapon.



b. Furniture:

- i. If a built-in desk or table is provided, it is preferred to be sturdy and firmly attached to the floor or walls and

contain a lockable file drawer for forms and a lockable box drawer for pens, pencils, staplers, etc. All loose items should be kept in drawers and out of sight.

- ii. The use of laptop or tablet computers in these rooms is preferable to minimize cords and wires that patients may be able to access. If desktop computers are provided, they are suggested to be located so the patient cannot easily reach them.

8. Electrical

- a. **Light Fixtures** – Dimmable wall or ceiling washing light fixtures are suggested so that lower levels (and possibly warmer color temperatures) are available to provide a less stimulating environment. See Baseline

9. Communications

- a. **Telephone Sets** – are suggested to be cordless phones to reduce the number of wires that may be available to patients. If standard telephones are provided, it is suggested that they be located as far away from patients as possible or in lockable cabinets.
- b. **Nurse Calls / Duress Alarms** If a personal duress alarm system⁶⁵⁰ is not present, an emergency call button⁶⁵⁴ for use by staff is strongly suggested to be provided so staff may summon additional staff members if necessary.



#650f



#654

10. Electronic Safety

- a. **Metal Detectors**⁶⁶⁰ – may be provided in the Admissions area to assist with screening incoming patients for contraband. See Baseline

Level V-b. Seclusion Rooms and Restraint Rooms



All items shall be the same as Level IV with the following exceptions:

Seclusion Rooms and Restraint Rooms are very similar in design and construction with the size and furniture being the two main differentiating features. The **FGI Guidelines** require Seclusion Rooms to be a minimum of 60 square feet in floor area and Restraint rooms to be a minimum of 80 square feet in floor area. They should be no less than 7 feet wide and no greater than 11 feet long to avoid providing enough space for a patient to get a running start at the opposite wall. They should be designed to

This document is intended to represent leading current practices, in the opinion of the authors. It does not represent minimum acceptable conditions or establish a legal “standard of care” that facilities are required to follow.

minimize blind spots where patients cannot be observed by staff without entering the room and outside corners are to be avoided, where possible. A minimum ceiling height of 9 feet is preferred.

The distance of the seclusion room from the nurse station needs to be considered. The goal is to avoid excessive distance so staff can be readily available as needed. The seclusion room door should swing out of the room and open directly into an anteroom to separate these activities from other patients and give the patient access to a toilet without entering the corridor

1. Openings

a. Doors - Heavy-duty, commercial-grade steel doors with a minimum clear width of 3'-8" (usually requires nominal 4'-0" wide doors) that are hinged to swing out of the room. Polycarbonate²⁰¹ view windows not to exceed 100 square inches is strongly suggested to allow staff to observe the patient and determine the location of the patient before opening the door. The height of the window should allow shorter staff members to see into the room.

b. Door Hardware:

- i. Exposed door hardware is typically not provided on the inside face of these doors.
- ii. The seclusion room door is preferred to have three-point latching with manual activation of a single lever required to engage all three bolts.¹⁶⁰ This operation greatly reduces the risk of a staff becoming locked in the room with a patient.

c. Windows:

- i. Exterior – If exterior windows are present, they are suggested to be a minimum of ½" thick polycarbonate and have either mini-blinds or roller blinds that have motorized operation controllable from the Ante Room.
- ii. Interior – See comments on view window in the door above. Other interior windows in these rooms are discouraged to help avoid over-stimulation of patients.



#160d

2. Finishes

a. Walls:

This document is intended to represent leading current practices, in the opinion of the authors. It does not represent minimum acceptable conditions or establish a legal "standard of care" that facilities are required to follow.

- i. Padded wall finish is often provided which has either a Kevlar-facing or heavy vinyl facing and 1 1/2" thick foam backing.²⁷⁰
- ii. Unpadded - Impact-resistant gypsum board²³⁰ over 3/4" plywood (or 25 gauge sheet metal which stiffens the wall, is easily cut and does not require wider door frames) on minimum 20-gauge metal studs at 16" on center with high performance finish.²⁸⁰

b. Ceilings – Impact-resistant and/or abrasion-resistant gypsum board^{230, 231} painted with high performance finish²⁸⁰ at 9'-0" minimum height is preferred.

c. Wall Base:

- i. Unpadded – Use of a separate base material is not recommended in these rooms. If painted, exposed gypsum board finish is provided; it is preferred that it be extended to the floor and a pick-resistant caulk joint be provided at the floor. A painted stripe that is 4" or 6" high may be provided to help hide scuffing and marking on the wall.
- ii. Padded – No base is typically provided, the padding extends to the top of the flooring.

d. Flooring – Provide continuous sheet vinyl with foam backing and heat-welded seams²⁷² or padded flooring to match wall padding.



3. Specialties

a. Mirrors and Domes – Observation Mirror – Install a convex mirror⁴²⁰ at the ceiling in the corner of the room opposite the seclusion room door. Make sure the mirror can be seen when viewing it from the window in the door. This mirror will give staff a full view of the room prior to opening the door. Care shall be taken to assure the attachment is secure so the patient cannot remove it and have a weapon and the perimeter is sealed with pick-resistant caulk.

4. Furnishings

No furniture is typically provided in Seclusion rooms, only a behavioral health mattress on the floor.

a. a. Furniture:

- i. Seclusion rooms are suggested to have only a behavioral health care mattress⁴⁹² on the floor or a special seclusion room bed.^{493a} These beds should not have loops to which mechanical restraints may be attached because these are ligature attachment points for secluded patients.
- ii. Restraint rooms are suggested to have special beds with loops for attachment of restraint straps.⁴⁹⁷ These beds are typically anchored in place and positioned to allow space for access on at least three sides, if not all four sides.
- iii. If a room will be used for patients that are both in restraints and in seclusion (without restraints), there are several beds available that have restraint attachment loops that may be quickly and easily removed.⁴⁹⁸



5. Fire Suppression

- a. **Fire Sprinkler Heads** - Institutional Type – Same as for Level IV

6. Plumbing Fixtures and Fittings

- a. **Same as those in Level IV-B** except that toilet fixtures of Powder-coated stainless-steel fixtures⁵³⁴ or solid surface material⁵³³ are preferred by some facilities.

7. HVAC

- a. **Diffusers, Registers and Grilles HVAC grilles** - Fully recessed, vandal-resistant grilles with S-shaped air passageways⁶⁰⁰
- b. **Thermostats** – These are preferred to be a digital type with control mounted on the wall in the anteroom and sensor in the return air duct serving the room.

8. Electrical

- a. **Electrical Devices.** No electrical outlets, switches, thermostats, blank cover plates, or similar devices are permitted inside seclusion rooms.
- b. **Light Fixtures. Light Fixtures** – Fully recessed, moisture-resistant, vandal-resistant light fixtures⁶²⁰ⁱ installed in the ceiling are recommended. Dimmable wall or ceiling washing light fixtures are suggested so that lower levels (and possibly more soothing colors) are available to provide a less stimulating environment.

9. Communications

- a. **Telephone Sets** - None allowed.
- b. **Nurse Calls / Duress Alarms** – None allowed, it is typical that a staff member is assigned to continuously observe the patient in these rooms. A staff assist call button⁶⁵³ mounted in the Anteroom may be required by the FGI Guidelines

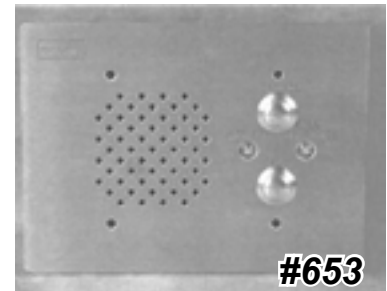

Summary

Thoughtful consideration of these design elements and materials by design team members and hospital staff can result in a very aesthetically pleasing environment that will enhance the treatment process and help maximize safety for patients, staff, and visitors. It is strongly recommended that wall-hung lavatories, 2'x4' fluorescent light fixtures, paddle-handle door hardware, and many other items typically found in general hospitals **NOT** be used in behavioral health facilities. The reasons these are used in general hospitals typically do not exist in behavioral health care units. Their elimination will significantly reduce the institutional character of behavioral health facilities without decreasing patient or staff safety.

As stated in the introduction, this document is intended to represent leading current practices and does not establish minimum standards for behavioral health facilities or represent requirements of codes or regulatory agencies, except as noted. No product or built environment is entirely without risk.

The authors' desire is that hospital staff and their design teams will use this information to start conversations about what is the best solution for each individual facility's patients and staff.

The Baseline level of concern in Section A is intended to represent a typical level of risk tolerance for inpatient units. This baseline is adjusted up or down for the levels of concern in the environmental safety risk assessment matrix as discussed herein.

Appendix Index

01 00 00 – General	79	21 00 00 - Fire Suppression	132
01 00 01 – Trash Receptacle Liner	79	21 13 13 - Fire Suppression Sprinkler Systems	132
07 00 00 – Thermal and Moisture Protection	79	22 43 00 – Plumbing Fixtures	133
07 92 00 – Joint Sealants	79	22 43 13 – Healthcare Water Closets	133
08 00 00 - OPENINGS	80	22 43 16 – Healthcare Sinks	134
08 10 00 – Doors and Frames	80	22 43 19 – Healthcare Bathtubs and Showers.	135
08 31 13 – Access Doors	81	22 43 23 – Shower Receptors and Basins.	138
08 34 00 – Special Function Doors	81	22 43 39 – Healthcare Faucets	140
08 51 13 – Aluminum Windows	84	22 43 43 – Plumbing Fixture Flushometers	141
08 56 56 – Security Window Screens	85	22 47 00 – Water Station Water Coolers.	143
08 71 00 – Door Hardware.	85	22 60 00 – Gas and Vacuum Systems	144
08 87 53 – Security Films	96	23 00 00 – Heating, Ventilating, A/C	145
08 88 53 – Security Glazing	96	23 37 13 – Diffusers, Registers and Grilles	145
09 00 00 – Finishes	99	26 27 26 – Electrical Devices	148
09 21 16 – Gypsum Board	99	26 51 00 – Interior Lighting	149
09 50 00 – Ceilings	101	26 53 00 – Exit Signs	152
09 65 13 – Resilient Base	101	26 55 53 – Security Lighting	153
09 65 16 – Resilient Flooring	102	27 00 00 – Communications	153
09 67 00 – Fluid-Applied Flooring	102	27 32 13 – Telephone Sets.	153
09 68 16 – Sheet Carpeting	103	27 52 23 – Nurse Call/Code Blue Systems	154
09 77 00 – Special Wall Surfacing	103	28 00 00 – Electronic Safety and Security	155
09 96 13 – Abrasion Resistant Coatings.	104	28 40 00 – Electronic Monitoring and Control	155
10 12 00 – Display Cases	104	32 00 00 – Exterior Improvements	155
10 14 00 – Signage	105	32 31 13 – Security Fencing	155
10 26 16.16 – Protective Corridor Handrails	106		
10 26 23 – Protective Wall Covering.	106		
10 28 13 – Security Toilet Accessories	107		
10 86 00 – Security Mirrors and Domes	115		
12 21 13 – Horizontal Louver Blinds	115		
12 21 33 – Roll-Down Blinds.	116		
12 35 70 – Healthcare Case Work	117		
12 44 16 – Shower Doors	118		
12 46 23 – Decorative Crafts	120		
12 52 70 – Healthcare Seating.	120		
12 56 70 – Healthcare Furniture	125		
12 93 43 – Site Furnishings - Seating and Tables	132		

This document is intended to represent leading current practices, in the opinion of the authors. It does not represent minimum acceptable conditions or establish a legal “standard of care” that facilities are required to follow.

01 00 00 – General

01 00 01 – Trash Receptacle Liner

- 1a. Trash receptacle liner – paper

Sani-liner®

Wisconsin Converting
Green Bay, WI
920-593-8297

www.wisconsinconverting.com



- 1c. Trash receptacle liner – paper

Psych-Select-Bag™

Dano Group
Stamford, CT
800-348-3266

www.danoinc.com



#1c

07 00 00 – Thermal and Moisture Protection

07 92 00 – Joint Sealants

- 10a. Sound and Smoke Seals – Breakaway

Cush'N'Seal w/breakaway anti-ligature option

Door and Hardware Systems, Inc.
Rochester, NY
585-235-8543

www.dhsi-seal.com

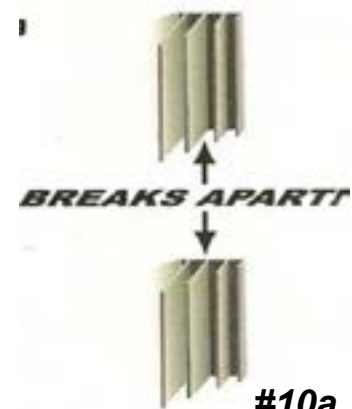

#10a

- 10b. Sound and smoke seals – breakaway

Ligature-resistant Zag option

Zero International – Allegion
Indianapolis, IN
877-671-7011

www.zerointernational.com



#10b

- 10c. Sound and smoke/fire seals – breakaway

Adhesive gaskets - perforated

Pemko Manufacturing Company
Memphis, TN
800-824-3018

www.pemko.com

Inclusion or exclusion of a product does not indicate endorsement or disapproval of that product, nor does it suggest that any product is free of risk. All products must be in compliance with the Safety Risk Assessment for each location.

20a. Pick-resistant caulk

Dynaflex™ SC

Pecora Corporation
Harleysville, PA
800-523-6688
www.pecora.com

20b. Pick-resistant caulk

Everseal # SB-190

Surebond
St. Charles, IL 60174
877-843-1818
www.surebond.com

20c. Pick-resistant caulk

Masterea® #CR 190

BASF Construction Chemicals
Shakopee, MN 55379
800-243-6739
www.master-builders-solutions.basf.us



#20b

08 00 00 - OPENINGS

08 10 00 – Doors and Frames

25a. Synthetic faced door

Acrovyn® Doors

Construction Specialties
Lebanon, NJ 08833
800-972-7214
www.c-sgroup.com



#25a

25b. Synthetic-faced door-

Thermal-Fused Doors

ASSA ABLOY Door Group
c/o Maiman
Springfield, MO 65803
417-616-8234
www.assaabloywooddoors.com



#25b

Inclusion or exclusion of a product does not indicate endorsement or disapproval of that product, nor does it suggest that any product is free of risk. All products must be in compliance with the Safety Risk Assessment for each location.

08 31 13 – Access Doors

30.a Access panel – lockable

SP Steel Security Panel with mortise deadbolt prep

J. L. Industries, Inc.

Bloomington, MN 55435

800-554-6077

www.jlindustries.com



30.b Access panel – lockable

Security Access Panel with tamper resistant latches & rounded corners

Weizel Security

800-308-3627

www.securingshospitals.com



08 34 00 – Special Function Doors

40a. Patient toilet door

Wanford En-Suite Bathroom Door

Safehinge-Primera

UK

0330-058-0988

www.safehingeprimera.com



40b. Patient toilet door

En-Suite Patient Bathroom Door w/ Shower Door

Option: #SHDUS02

Kingsway Group USA

Royal Oak, MI 48073

800-783-7980

www.kingswaygroupusa.com

NOTE: Hinge only, see Item 111g; Rubber fin only, see item 473e

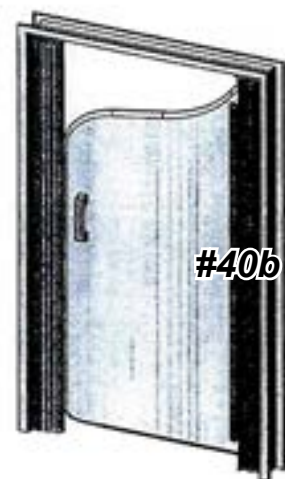

Inclusion or exclusion of a product does not indicate endorsement or disapproval of that product, nor does it suggest that any product is free of risk. All products must be in compliance with the Safety Risk Assessment for each location.

40c. Patient Toilet Door

Ligature Resistant Sliding Door System with Frame

Accurate Lock and Hardware

Stamford, CT 06902

203-348-8865

www accuratelockandhardware.com

40d. Patient toilet door

Sentinel Event Reduction Door

Norva Plastics, Inc.

Norfolk, VA 23508

800-826-0758

www.norvaplastics.com

40e. Patient toilet door

Soft Suicide Prevention Door

Kennon Products, Inc.

Sheridan, WY 82801

307-674-6498

www.suicideproofing.com

44b. Wicket doors

Acrovyn® Barrier-Resistant Doors

Construction Specialties

Lebanon, NJ 08833

800-972-7214

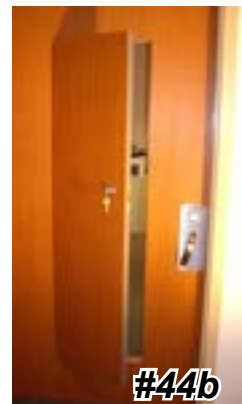
www.c-sgroup.com

Inclusion or exclusion of a product does not indicate endorsement or disapproval of that product, nor does it suggest that any product is free of risk. All products must be in compliance with the Safety Risk Assessment for each location.

44c. Wicket doors

Behavioral Health Series Patient Room Access Door

ASSA ABLOY Door Security Solutions

New Haven, CT 06511

800-377-3948

www.assaabloydss.com

#44c

44d. Wicket doors

Wicket Door (Wood Doors)

Marshfield Door Systems

Marshfield, WI 54449

800-869-3667

www.marshfielddoors.com

44e. Wicket doors

GCD-EC Flush Wicket Door with structural composite lumber core

Graham Wood Door

Mason City, Iowa 50401

641-423-2444

www.grahamdoors.com

#47a

47a. Security sidelight

Security Sidelite Unit

Curries Company

Mason City, IA 50401

641-423-1334

www.curries.com

47b. Security sidelight

Security SideLite Unit

Ceco Door

Milan, TN 38358

www.cecodoor.com

#47b

Inclusion or exclusion of a product does not indicate endorsement or disapproval of that product, nor does it suggest that any product is free of risk. All products must be in compliance with the Safety Risk Assessment for each location.

08 51 13 – Aluminum Windows

60a. Aluminum window with integral blind

2450 Series Storefront with hinged sash and integral blind

Manko Window Systems, Inc.

Manhattan, KS 66502

800-642-1488

www.mankowindows.com

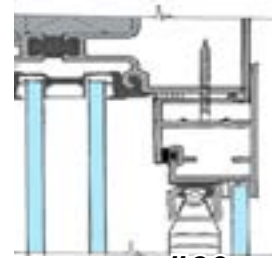

#60a

60b. Aluminum window with integral blind

2187-DT Psychiatric Windows with integral blind

Wausau Window and Wall Systems

Wausau, WI 54401

877-678-2983

www.wausauwindow.com



#60b

60c. Aluminum window with integral blind - removable

SS-5100 Medium-Security Mental Health Security Window

Sherwood Windows Group

Toronto, Ontario M9W 5E3

Canada

800-770-5256

www.sherwoodwindows.com



#61a

61a. Exterior windows - ventilation

Safevent Windows

Britplas

Woolston, Warrington WA1 4RW

England

+44-1925-824317

www.britplas.com

61b. Exterior windows - ventilation

SW-6300 Operable Security Window

Sherwood Windows Group

Toronto, Ontario M9W 5E3

Canada

800-770-5256

www.sherwoodwindows.com



#61b

Inclusion or exclusion of a product does not indicate endorsement or disapproval of that product, nor does it suggest that any product is free of risk. All products must be in compliance with the Safety Risk Assessment for each location.

61c. Exterior windows - ventilation

512 Ventrow Ventilator

Kawneer North America
Norcross, GA 30092
770-449-5555
www.kawneer.com

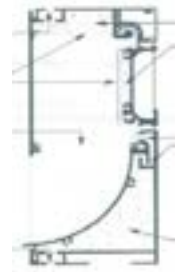

08 56 56 – Security Window Screens

80. Security screens

Security Screens

Kane Innovations
Erie, PA 16506
800-773-2439
www.kanescreens.com



08 71 00 – Door Hardware

100a. Door closer

Concealed closer #2010 Series

LCN
Princeton, IL 61356-0100
877-671-7011
us.allegion.com/brands/lcn/Pages/default.aspx

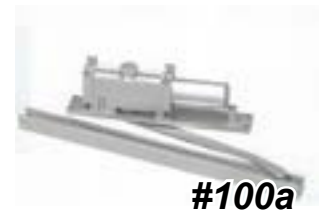

100b. Door closer

High-security track closer #4510T SMOOTHIE® Series

LCN
121 West Railroad Avenue
Princeton, IL 61356-0100
877-671-7011
us.allegion.com/brands/lcn/Pages/default.aspx

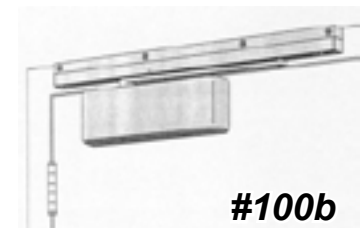

101. Electrically controlled door closer

Fire/Life Safety Series HSA Sentronic Electrically Controlled Closer/Holder

LCN

P.O. Box 100

Princeton, IL. 61356-0100

815-875-3111

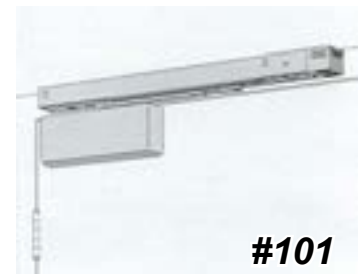
us.allegion.com/brands/lcn/Pages/default.aspx

109. Electric-release concealed deadbolts

ELECTRATM concealed vertical rod latching lever locksets

Securitech Group, Inc.

Maspeth, NY 11378

800-622-5625

www.securitech.com

110. Electromagnetic lock

Electromagnetic Locks

DynaLock Corporation

Bristol, CT 06010

877-396-2562

www.dynalock.com

111a. Continuous hinges – gear type with hospital tip

780-Series Roton Hinges

Hager Companies

St. Louis, MO 63104

800-325-9995

www.hagerco.com/Product-Listing.aspx?CatID=152&SubCatID=189

111b. Continuous hinges – gear type with hospital tip

112HD Concealed Continuous Hinge

Ives

Indianapolis, IN 46219

877-671-7011

us.allegion.com

Inclusion or exclusion of a product does not indicate endorsement or disapproval of that product, nor does it suggest that any product is free of risk. All products must be in compliance with the Safety Risk Assessment for each location.

111c. Continuous hinges – gear type with hospital tip
825-S22 SR™ SR824-S22 SafeSupport Continuous Gear Hinge

Weizel Security

800-308-3627

www.securingshospitals.com

111e. Continuous hinges – gear type with hospital tip
Continuous Geared Hinge # KG200

Kingsway Group USA

Royal Oak, MI 48073

800-783-7980

www.kingswaygroupusa.com



#111e

111f. Continuous Hinges – gear type with hospital tip
SL11 Concealed single acting continuous geared hinge

Select Products Limited

Portage MI 49024

800-423-1174

www.selecthinges.com



#111f

111g. Continuous hinges
Anti-Ligature Continuous Swing Hinge for Shower w/ Cap# KG203

Kingsway Group USA

Royal Oak, MI 48073

800-783-7980

www.kingswaygroupusa.com

113a. Double-acting continuous hinge
Double Swing Hinge #DSH1000 Barrel Type

Markar

Memphis, TN 38181

www.assaabloydooraccessories.us/en/local/assaabloydooraccessoriesus/products/hinges/continuous-pin-barrel-hinges/behavioral-health-hinges/



#113a

Inclusion or exclusion of a product does not indicate endorsement or disapproval of that product, nor does it suggest that any product is free of risk. All products must be in compliance with the Safety Risk Assessment for each location.

113c. Double-acting continuous hinge

Swing Hinge # KG202

Kingsway Group USA
 Royal Oak, MI 48073
 800-783-7980

www.kingswaygroupusa.com



113d. Double-acting continuous hinge

Switch Hinge # KG280

Kingsway Group USA
 Royal Oak, MI 48073
 800-783-7980

www.kingswaygroupusa.com



#113d

115b. Emergency stop

Emergency Release Stop #ERS

Pemko Manufacturing Company
 Memphis, TN 38141
 800-824-3018

www.pemko.com



Open
 #115b



Normal
 #115b

115c. Emergency stop

Swing Stop # LG205, LG206

Kingsway Group USA
 Royal Oak, MI 48073
 800-783-7980

www.kingswaygroupusa.com

120. Door pull

Vandal-Resistant Door Pull Trim # VR910-DT

Ives
 Indianapolis, IN 46219
 877-671-7011

us.allegion.com



#120

Inclusion or exclusion of a product does not indicate endorsement or disapproval of that product, nor does it suggest that any product is free of risk. All products must be in compliance with the Safety Risk Assessment for each location.

121c. Door pull, recessed

Heavy Duty Security Flush Pull # D89

Rockwood Manufacturing Company
Rockwood, PA 15557
800-458-2424
www.rockwoodmfg.com



121d. Door pull, recessed

Heavy Duty ADA Security Flush Pull # BF97L

Rockwood Manufacturing Company
Rockwood, PA 15557
800-458-2424
www.rockwoodmfg.com



130a. Ligature-resistant lever handle lockset

Anti Ligature Lockset (Mortise and Cylindrical) #SPSL

Best Access Systems
Indianapolis, IN 46250
317-849-2250
www.bestaccess.com/index.php/products/behavioral-health-products/



130b. Ligature-resistant lever handle lockset

Schlage L Series Extra Heavy Duty Mortise Lock with ligature resistant lever

Allegion
877-671-7011
us.allegion.com/IRSTDocs/Brochure/106510.pdf



130c. Ligature-resistant lever handle lockset

Series 5SS19 Institutional Life Safety Mortise Locksets - Levers

Marks USA
Amityville, NY 11701
800-526-0233
www.marksusa.com



Inclusion or exclusion of a product does not indicate endorsement or disapproval of that product, nor does it suggest that any product is free of risk. All products must be in compliance with the Safety Risk Assessment for each location.

130d. Ligature-resistant lever handle lockset

LSL Life Safety Lever Series

Grainger

Lake Forest, IL 60045

800-472-4643

www.grainger.com



#130d

131a. Ligature-resistant modified lever handle lockset

8200 with BHW Trim

Sargent Manufacturing Company

100 Sargent Drive

New Haven, CT 06536-0915

800-727-5477

www.sargentlock.com



#131a

131b. Ligature-resistant modified lever handle lockset

Crescent Handle – horizontal installation

Accurate Lock and Hardware

Stamford, CT 06902

203-348-8865

www accuratelockandhardware.com



#131b

131c. Ligature-resistant modified lever handle lockset

Securitech; Solis handle available for both mortise and cylindrical locksets)

Securitech Group, Inc.

Maspeth, NY 11378

800-622-5625

www.securitech.com/securiguard/



#131c

131d. Ligature-resistant modified lever handle lockset

HD Ligature Resistant Cylindrical Lock CH-CYL Series

Accurate Lock and Hardware

Stamford, CT 06902

203-348-8865

www accuratelockandhardware.com



#131d

Inclusion or exclusion of a product does not indicate endorsement or disapproval of that product, nor does it suggest that any product is free of risk. All products must be in compliance with the Safety Risk Assessment for each location.

132a. Ligature-resistant lockset

Ligature Resistant Push/Pull 9125ALP

Accurate Lock and Hardware

Stamford, CT 06902

203-348-8865

www accuratelockandhardware.com

#132a

140. Patient room privacy lockset

Patient Room Privacy Lockset

Best Access Systems

Indianapolis, IN 46250

800-392-5209

www.bestaccess.com/products/behavioral-health-products/

#140

141a. Cylinder protector

Securiguard Cylinder Protector; Model #63LR

Securitech Group, Inc.

Maspeth, NY 11378

800-622-5625

www.securitech.com/securiguard/

#141a

141b. Cylinder protector

ShieldX Cylinder Protector

Grainger

Lake Forest, IL 60045

800-472-4643

www.grainger.com

#141b

Inclusion or exclusion of a product does not indicate endorsement or disapproval of that product, nor does it suggest that any product is free of risk. All products must be in compliance with the Safety Risk Assessment for each location.

143a. Deadbolt

Deadbolt with ligature-resistant turn piece (retract bolt only) #PBL102-630

Securitech Group, Inc.
Maspeth, NY 11378
800-622-5625
www.securitech.com



143b. Deadbolt

Vertical Deadbolt with ligature-resist. turn piece (retract bolt only) #52XXV-F17

Securitech Group, Inc.
Maspeth, NY 11378
800-622-5625
www.securitech.com

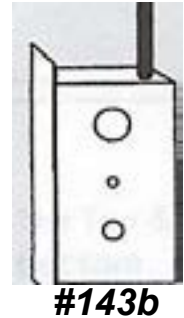

144. Sallyport interlock hardware

RACHIE™ series lockset package

Securitech Group, Inc.
Maspeth, NY 11378
800-622-5625
www.securitech.com



145. Remote authorization

Assa Cliq Remote Authorization System

Assa Abloy
www.assaboly.com



146. Ball catch

Dual Adjustable Ball Catch #347

Ives
 Indianapolis, IN 46219
 877-671-7011
us.allegion.com



147. Roller latch

Roller Latch # RL30

Ives
 Indianapolis, IN 46219
 877-671-7011
us.allegion.com



148. Magnetic latch

Super-Mite Heavy Duty Magnetic Catch #327

Ives
 Indianapolis, IN 46219
 877-671-7011
us.allegion.com



150a. Over-door alarm

The Door Switch

St. Louis, MO 63146
 877-998-5625
thedoorswitch.com



150b. Over-door alarm

Top Door Alarm®

Door Control Services, Inc.
 Ben Wheeler, TX 75754
 800-356-2025
www.doorcontrolservices.com



Inclusion or exclusion of a product does not indicate endorsement or disapproval of that product, nor does it suggest that any product is free of risk. All products must be in compliance with the Safety Risk Assessment for each location.

150c. Over-door alarm

SEDA Door Alarm

Best Access Solutions, Inc.
Indianapolis, IN 46250

www.bestaccess.com/products/behavioral-health-products/



150d. Over-door alarm

LISA-Kit (Life Safety Alarm)

Grainger
Lake Forest, IL 60045
800-472-4643

www.grainger.com



150d. Over-door alarm

DAISY – Over-the-Door Alarm)

Securitech Group, Inc.
Maspeth, NY 11378
800-622-5625

www.securitech.com



160a. Seclusion room door locks

Seclusion Room Lock (surface mount)

Securitech
Maspeth, NY 11378
800-622-5625

www.securitech.com



160b. Seclusion room door locks

Multi-Point Deadbolt Mortise Lock - UML Series (concealed mount)

Securitech
Maspeth, NY 11378
800-622-5625

www.securitech.com



Inclusion or exclusion of a product does not indicate endorsement or disapproval of that product, nor does it suggest that any product is free of risk. All products must be in compliance with the Safety Risk Assessment for each location.

160c. Seclusion room door locks

Schlage; Multipoint Solution # LM9300

Ingersoll Rand Security Technologies

Carmel, IN 46032 US

877-671-7011

us.allegion.com/IRSTDocuments1/104833.pdf

#160c

160d. Seclusion room door locks

Multi-Bolt Self-Latching Concealed Locksets (USL Series)

Securitech

Maspeth, NY 11378

800-622-5625

www.securitech.com

#160d

161. Cross-corridor door locks

Electra Concealed Vertical Rod Latching Lever Locksets #109

Securitech

Maspeth, NY 11378

800-622-5625

www.securitech.com

#161

162. Elopement buffer or sallyport door locks

RACHIE Entry & Exit Control Systems

Securitech

Maspeth, NY 11378

800-622-5625

www.securitech.com

175a. Wall Stops

KG184 Anti-Ligature Rubber Wall Stop

Kingsway Group USA

Royal Oak, MI 48073

800-783-7980

www.kingswaygroupusa.com

#175a

Inclusion or exclusion of a product does not indicate endorsement or disapproval of that product, nor does it suggest that any product is free of risk. All products must be in compliance with the Safety Risk Assessment for each location.

175b. Wall Stops

KG270-278 Anti-Ligature Extended Rubber Wall Stop

Kingsway Group USA

Royal Oak, MI 48073

800-783-7980

www.kingswaygroupusa.com

#175b

08 87 53 – Security Films

190a. Window film

Scotchshield™ Ultra – 14 mil Film with Perimeter Attachment System

3M Specified Construction Products Department

St. Paul, MN 55144

888-364-3577

www.3m.com

190b. Window film

200 Series – Safety and Security Laminate

ACE (Advanced Coatings Engineering)

Newark, DE 19713

888-607-0000

www.usace.com**08 88 53 – Security Glazing**

200a. Security glazing

121000 or 121100 ArmorProtect Plus®

Oldcastle Building Envelope®

Dallas, TX 75244

866-653-2278

www.obe.com

200b. Security glazing

9/16Psych-2118

Global Security Glazing

Selma, AL 36703

(800) 633-2513

www.security-glazing.com**(NOTE: meets ASTM F1233 Class 1.4)**

#200b

Inclusion or exclusion of a product does not indicate endorsement or disapproval of that product, nor does it suggest that any product is free of risk. All products must be in compliance with the Safety Risk Assessment for each location.

200c. Security glazing

Laminated Annealed Glass w/ SGP Interlayer

Global Security Glazing

Selma, AL 36703

(800) 633-2513

www.security-glazing.com

201a. Polycarbonate sheet glazing – abrasion-resistant

MR10 LEXAN - MARGARD II Sheet

SABIC Americas

Pittsfield, MA 01201

800-323-3783

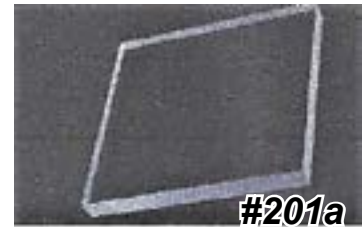
www.sabic.com

201b. Polycarbonate sheet glazing

Makrolon® GP Sheet

Covestro LLC

Pittsburgh, PA 15205-9723

877-229-3778

www.sheets.covestro.com

205a. Fire-rated glazing

Fireglass; FireLite®

Technical Glass Products (TGP) (Allegion)

800-426-0279

www.fireglass.com

205b. Fire-rated glazing

Fireglass; WireLite® - NT

Technical Glass Products (TGP) (Allegion)

800-426-0279

www.fireglass.com

Inclusion or exclusion of a product does not indicate endorsement or disapproval of that product, nor does it suggest that any product is free of risk. All products must be in compliance with the Safety Risk Assessment for each location.

220a. Vision panels

Vision panels, key operation

VISTAMATIC®

Coral Springs, FL 33065

866-466-9525

www.vistamaticvisionpanels.com

220b. Vision panels

Duralux Secure Privacy Vision Panel

Kingsway Group USA

Royal Oak, MI 48073

800-783-7980

www.kingswaygroupusa.com

#220b

220c. Vision panels**ViuLite manual or motorized blinds inside glass panels**

Unicel Architectural Corp.

Longueuil, Quebec, Canada J4G 2J4

800-668-1580

www.unicelarchitectural.com

#220c

220d. Vision panels

Between Glass Blinds vision panels

VISTAMATIC, LLC

Coral Springs, FL 33065

866-466-9525

www.betweenglassblinds.com

#220d

Inclusion or exclusion of a product does not indicate endorsement or disapproval of that product, nor does it suggest that any product is free of risk. All products must be in compliance with the Safety Risk Assessment for each location.

220e. Vision panels

IE; Blinds® sealed, integral blind assemblies

IE Blinds

Ben Wheeler, TX 75754

866-267-1917

www.ieblinds.com

#220e

221a. Vision panels

Clarity Privacy Glass (electric)

VISTAMATIC®

Coral Springs, FL 33065

866-466-9525

www.vistamaticvisionpanels.com

#221a

221b. Vision Panels

Duralux Platinum Switchable Vision Panel (electric)

Kingsway Group USA

Royal Oak, MI 48073

800-783-7980

www.kingswaygroupusa.com

#221b

09 00 00 – Finishes

09 21 16 – Gypsum Board

230a. Impact-resistant gypsum board

Sheetrock® Brand engineered gypsum panels – abuse-resistant

USG Corporation

Chicago, IL 60661

800-874-4968

www.usg.com

230b. Impact-resistant wallboard

Gold Bond® Brand Hi-Impact® XP® Gypsum Board – moisture- and fire-resistant also has abrasion resistant paper face

National Gypsum Company

Charlotte, NC 28211

704-365-7300

www.nationalgypsum.com

Inclusion or exclusion of a product does not indicate endorsement or disapproval of that product, nor does it suggest that any product is free of risk. All products must be in compliance with the Safety Risk Assessment for each location.

230c. Impact-resistant wallboard

Extreme Impact Resistant Type X Gypsum Board

CertainTeed Corporation

Melvern, PA 19355

800-233-8990

www.certainteed.com

231a. Abrasion-resistant wallboard

Gold Bond® Brand Hi-Abuse® XP® Gypsum Board

National Gypsum Company

Charlotte, NC 28211

704-365-7300

www.nationalgypsum.com

231b. Abrasion-resistant wallboard

Extreme Abuse Resistant Type X Gypsum Board

CertainTeed Corporation

Melvern, PA 19355

800-233-8990

www.certainteed.com

232a. Sound-absorbing wallboard

QuietRock sound-reducing panels

PABCO® Gypsum

Newark, CA 94560

800-797-8159

www.quietrock.com

232b. Sound-absorbing wallboard

Silent FX Quick Cut Noise Reducing Type X Gypsum Board

CertainTeed Corporation

Melvern, PA 19355

800-233-8990

www.certainteed.com

232c. Sound Attenuation wallboard

Gold Bond® Soundboard® XP® Gypsum Board

National Gypsum Company

Charlotte, NC 28211

704-365-7300

www.nationalgypsum.com

09 50 00 – Ceilings

234a. Ceiling Accessories

MBAC – Main Beam Adapter Clip for attaching gyp. bd. to ceiling grid

Armstrong Ceiling Solutions

www.armstrongceilings.com

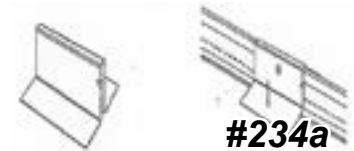

239a. Tamper-resistant ceiling panels

Metal Works; Vector

Armstrong Ceiling Solutions

877-276-7876

www.armstrongceilings.com

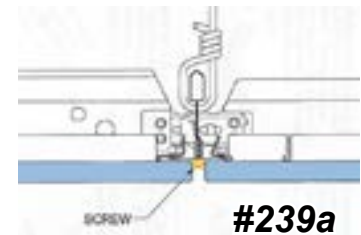

239b. Tamper-resistant ceiling panels

Metal Works; Clip-On

Armstrong Ceiling Solutions

877-276-7876

www.armstrongceilings.com

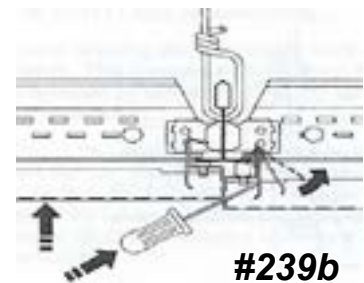

09 65 13 – Resilient Base

240. Wall base

Health Design™ Wall Base

FLEXCO® Corporation

Tuscumbia, AL 35674

800-633-3151

www.flexcofloors.com



Inclusion or exclusion of a product does not indicate endorsement or disapproval of that product, nor does it suggest that any product is free of risk. All products must be in compliance with the Safety Risk Assessment for each location.

241a. Wall base

Visuelle Wall Base

Roppe Corporation, USA
Fostoria, OH 44830
800-537-9527
www.roppe.com



241b. Wall base

Johnsonite “Millwork” Contours Wall Base – PV4065

Roppe Corporation, USA
Fostoria, OH 44830
800-537-9527
www.roppe.com



09 65 16 – Resilient Flooring

245a. Sheet vinyl flooring

Homogeneous Vinyl Sheet Flooring

Armstrong Flooring, Inc.
Lancaster, PA 17604
888-276-7876
www.armstrong.com

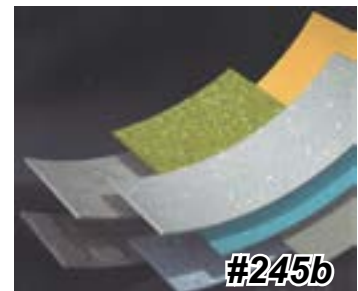

245b. Sheet vinyl flooring

Noraplan sheet flooring

nora® systems, Inc.
Salem, NH 03079
800-332-NORA
www.nora.com/us

09 67 00 – Fluid-Applied Flooring

250a. Seamless floors and base

Cheminert K flooring

Dex-O-Tex
Division of Crossfield Products Corp.
Roselle Park, NJ 07204
908-245-2800
www.dexotex.com

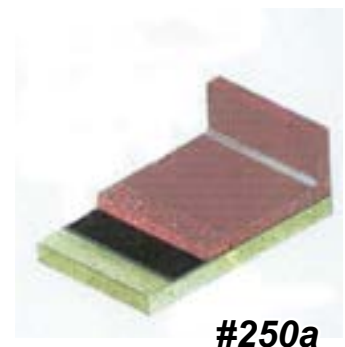

250b. Seamless floors and base

Inclusion or exclusion of a product does not indicate endorsement or disapproval of that product, nor does it suggest that any product is free of risk. All products must be in compliance with the Safety Risk Assessment for each location.

Seamless flooring systems

Dur-A-Flex, Inc.
 East Hartford, CT 06108
 877-2 51-5418
www.dur-a-flex.com

250c. Seamless floors and base

Sika Corp.; Sikafloor – no top edge trim at integral base

Sika Corporation
 Lyndhurst, NJ 07071
 800-933-7452
www.sikafloorusa.com

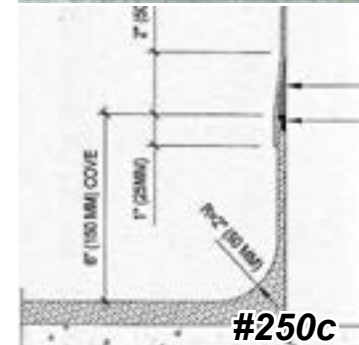
**09 68 16 – Sheet Carpeting**

255. Carpet

Mohawk Group GL 182 Exotic Fauna Sheet Carpet with Unibond Plus Bloc backing

Mohawk Group
 Calhoun, GA 30701
 800-554-6637
www.Mohawkgroup.com

09 77 00 – Special Wall Surfacing

270a. Wall padding

Gold Medal Safety Padding®

Marathon Engineering Corporation
 Lehigh Acres, FL 33913
 239-303-7378
goldmedalsafetypadding.com



270b. Wall padding

Surface padding systems

Padded Surfaces by B&E
 Indianapolis, IN 46241
 888-243-8788
paddedsurfaces.com

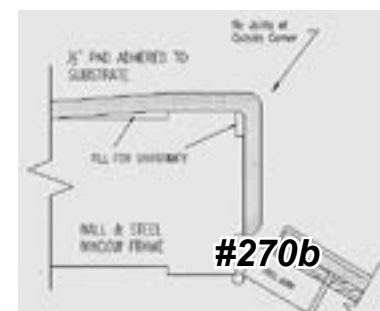

Inclusion or exclusion of a product does not indicate endorsement or disapproval of that product, nor does it suggest that any product is free of risk. All products must be in compliance with the Safety Risk Assessment for each location.

272. Seclusion room wall and floor material

Lonfloor Plain – smooth

Lonseal, Inc.
 Carson, CA 90745
 800-832-7111
www.lonseal.com

09 96 13 – Abrasion Resistant Coatings

280. Wall finish (do not use on floors)

Sto; Decocoat®

Sto Americas
 Building 1400, Suite 120
 Atlanta, GA 30331
 800-221-2397
www.stocorp.com

10 12 00 – Display Cases

290a. TV enclosure – suicide-resistant

TE450 Ligature-Resistant Protective TV Enclosure

Behavioral Safety Products
 Watkinsville, GA 30677
 706-705-1500
www.besafepro.com

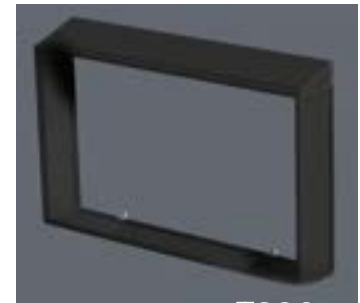

#290a

290b. TV Enclosure – suicide resistant

Protective Enclosures, FPE55F(H)-S

Peerless A-V
 Aurora, IL 60502
 800-865-2112
www.perlessmounts.com

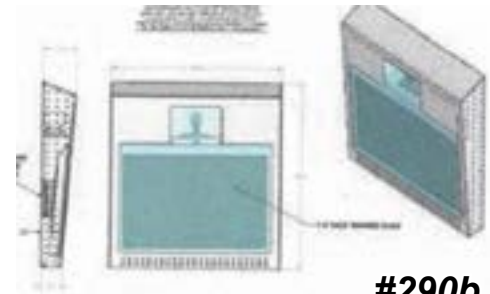

#290b

290c. TV enclosure – suicide-resistant

Ligature-resistant TV enclosure

ProEnc
 Jersey City, NJ 07302
 862-234-5981
www.lcdtvenclosure.com



#290c

Inclusion or exclusion of a product does not indicate endorsement or disapproval of that product, nor does it suggest that any product is free of risk. All products must be in compliance with the Safety Risk Assessment for each location.

10 14 00 – Signage

300a. Room signs

Flxsigns

2/90 Sign Systems
Grand Rapids, MI 49512
800-777-4310
www.290signs.com



300b. Room signs

Secure + spec

Creative Signage Systems, Inc.
College Park, MD 20740
800-220-7446
www.creativesignage.com



300c. Room signs

KING KMS® Modular Sign System

King Architectural Products
Bolton, ON, Canada, L7E 2R6
877-857-2804
www.kingarchitecturalproducts.com



300d. Room signs

Safecare Signs

2/90 Sign Systems
Grand Rapids, MI 49512
800-777-4310
www.290signs.com



Inclusion or exclusion of a product does not indicate endorsement or disapproval of that product, nor does it suggest that any product is free of risk. All products must be in compliance with the Safety Risk Assessment for each location.

10 26 16.16 – Protective Corridor Handrails

310a. Corridor handrail

Acrovyn® ligature-resistant handrail with continuous aluminum mounting bracket

Construction Specialties

Muncy, PA 17756

800-233-8493

www.c-sgroup.com



#310a

10 26 23 – Protective Wall Covering

320a. Synthetic wall protection

Avonite® Acrylic products - Wall Protection

Avonite

Belen, NM 87002

800-4-AVONITE

www.avonitesurfaces.com

320b. Synthetic wall protection

Acrovyn by Design® Wall Protection

Construction Specialties

Muncy, PA 17756

800-233-8493

www.c-sgroup.com



#320

320c. Synthetic wall protection

Ricochet Flexible Wall Protection

Inpro Corporation

Muskego, WI 53150

800-222-5556

inprocorp.com



#320c

Inclusion or exclusion of a product does not indicate endorsement or disapproval of that product, nor does it suggest that any product is free of risk. All products must be in compliance with the Safety Risk Assessment for each location.

10 28 13 – Security Toilet Accessories

332a. Grab bar

Anti-Ligature Grab Bar KG270-278

Kingsway Group USA

Royal Oak, MI 48073

800-783-7980

www.kingswaygroupusa.com



332b. Grab bar

Ligature - Resistant Grab Bar #GB730

Behavioral Safety Products

Watkinsville, GA 30677

706-705-1500

www.besafepro.com



332c. Grab bar

SAFEBAR® grab bar

Cascade Specialty Hardware, Inc.

Vancouver, WA 98660

360-823-3995

www.cascadesh.com



332d. Grab bar

SafeSupport® Safe-T Grab Bar #811-S01

Weizel Security

800-308-3627

www.securingshospitals.com



332e. Grab bar

NW SecurityBar®

Northwest Specialty Hardware, Inc.

Clackamas, OR 97015

503-557-1881

www.northwestsh.com



Inclusion or exclusion of a product does not indicate endorsement or disapproval of that product, nor does it suggest that any product is free of risk. All products must be in compliance with the Safety Risk Assessment for each location.

337. Grab bar – vertical

SP-3V Vertical Grab Bar

Odd Ball Industries
Greenlawn, NY 11740
631-754-0400
www.oddballindustries.com



**Cross
Section
#337**

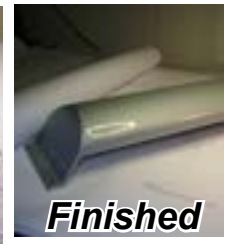

**Finished
End
#337**

340. Paper towel dispenser

Paper Towel Dispenser Cover #817-S45 SR™

Weizel Security
800-308-3627
www.securingshospitals.com



#340

340b. Paper towel dispenser

Paper Towel Dispenser # KG02

Kingsway Group USA
Royal Oak, MI 48073
800-783-7980
www.kingswaygroupusa.com



#340b

340c. Paper Towel Dispenser

Ligature - Resistant Paper Towel Dispenser #PH240

Behavioral Safety Products
Watkinsville, GA 30677
706-705-1500
www.besafepro.com



#340c

341. Roll Paper Towel Dispenser

Roll Paper Towel Dispenser #WH1848B

Whitehall Manufacturing
City of Industry, CA 91744
1-800-782-7706
www.whitehallmfg.com



#341

Inclusion or exclusion of a product does not indicate endorsement or disapproval of that product, nor does it suggest that any product is free of risk. All products must be in compliance with the Safety Risk Assessment for each location.

350a. Robe hook – break-away

Robe/Towel Hook # SP6

Odd Ball Industries Mfg. Co., Inc.
Greenlawn, NY 11740
1-631-754-0400
www.oddballindustries.com



350b. Robe hook – break-away

SafeSupport SR Collapsible Towel Hook # SR813-S08

Weizel Security
800-308-3627
www.securingshospitals.com

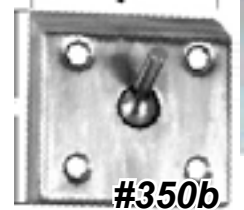

#350b

350d. Robe hook – break-away

Clothes Hook #NW 608

Northwest Specialty Hardware, Inc.
Clackamas, OR 97015
503-557-1881
www.northwestsh.com



#350d

350e. Robe hook – breakaway

Coat Hook # KG180

Kingsway Group USA
Royal Oak, MI 48073
800-783-7980
www.kingswaygroupusa.com



360a. Security Mirrors

Hybrid Safety Mirror in Guardian Frame

RAO Contract Sales, Inc.
392 Atwood Place
Wyckoff, NJ 07481
800-445-7065
www.rao.com



#360a

360b. Security Mirrors

ROVAL™ stainless steel mirror #20650-B

American Specialties, Inc.
Yonkers, NY 10701
914-476-9000
www.americanspecialties.com



#360b

Inclusion or exclusion of a product does not indicate endorsement or disapproval of that product, nor does it suggest that any product is free of risk. All products must be in compliance with the Safety Risk Assessment for each location.

360c. Security Mirrors

Security mirror #JOC-161

McGrory Glass, Inc.
Paulsboro, NJ 08066
856-579-3200

www.mcgrory-glass.com

360d. Security Mirrors

Sole - Illuminated Mirror for High Abuse Applications

Visa Lighting
Milwaukee, WI 53209
800-788-84272

www.visalighting.com



#360d

361a. Mirror guard

Mirror Guard # SP-8

Odd Ball Industries
Greenlawn, NY 11740
631-754-0400

www.oddballindustries.com



#361a

370a. Recessed shelf

Ligature-Resistant Recessed Shelf (front mount through flange) # RS780

Behavioral Safety Products
Watkinsville, GA 30677
706-705-1500

www.besafepro.com



#370a

370b. Recessed Shelf

Ligature-Resistant Recessed Shelf (front mount through flange) #KG12

Kingsway Group USA
2807 Samoset Road, Suite 200
Royal Oak, MI 48073
800-783-7980

www.kingswaygroupusa.com



#370b

370c. Recessed shelf

BestCare® Recessed Shelf (front mount through flange) # WH1820FA

Whitehall Manufacturing
 City of Industry, CA 91744-0527
 800-782-7706
www.whitehallmfg.com



370d. Recessed shelf

Recessed Shelf (front mount through side) # Model 412

American Specialties, Inc.
 Yonkers, NY 10701
 914-476-9000
www.americanspecialties.com



371c. Shelf – surface-mounted

Bookshelf # SA56

Bradley Corporation
 Menomonee Falls, WI 53051
 800-272-3539
www.bradleycorp.com



380a. Shower seat

ADA Shower Seat

Norix Group, Inc.
 West Chicago, IL 60185
 800-234-4900
www.norix.com



380b. Shower seat

ADA Shower Seat

Brey-Krause Manufacturing Co.
 Bethlehem, PA 18018
 610-867-1401
www.breykrause.com

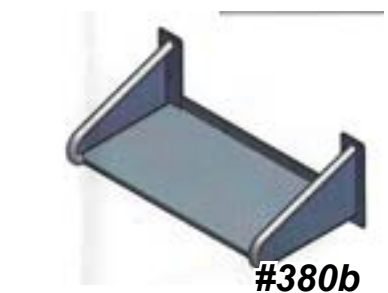

Inclusion or exclusion of a product does not indicate endorsement or disapproval of that product, nor does it suggest that any product is free of risk. All products must be in compliance with the Safety Risk Assessment for each location.

390a. Soap Dish

**Bestcare Bathroom Accessory Solutions #WH1832-PF
(front mount with plaster flange)**

Whitehall Manufacturing
City of Industry, CA 91744
1-800-782-7706
www.whitehallmfg.com



390b. Soap dish

Norix Group Inc.; Recessed Soap Dish (rear mount)

Norix Group, Inc.
West Chicago, IL 60185
1-800-234-4900
www.norix.com

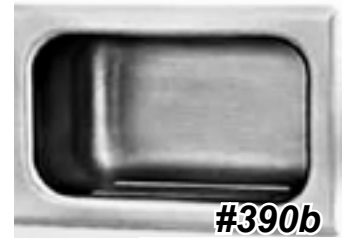

391a. Soap dispenser

KG08 Manual Soap Dispenser – Gojo Compatible

Kingsway Group USA
Royal Oak, MI 48073
800-783-7980
www.kingswaygroupusa.com



391b. Soap dispenser

ADX-12TM Security Enclosure

GOJO Industries, Inc.
Akron, OH 44309
800-321-9647
www.gojo.com



391c. Soap dispenser

Suicide Prevention Soap Dispenser

Norva Plastics, Inc.

Norfolk, VA 23508

800-826-0758

www.norvaplastics.com



391d. Soap dispenser

Ligature Resistant Soap Dispenser #SD750

Behavioral Safety Products

Watkinsville, GA 30677

706-705-1500

www.besafepro.com



#391d

400a. Toilet paper holder

Toilet Roll Holder # KG13

Kingsway Group USA

Royal Oak, MI 48073

800-783-7980

www.kingswaygroupusa.com



#400a

400b. Toilet paper holder

**Toilet Roll Holder #WH1847B Series (Recessed model
(1845B) also available)**

Whitehall Manufacturing

City of Industry, CA 91744

1-800-782-7706

www.whitehallmfg.com



#400b

Inclusion or exclusion of a product does not indicate endorsement or disapproval of that product, nor does it suggest that any product is free of risk. All products must be in compliance with the Safety Risk Assessment for each location.

400c Toilet paper holder

Surface Mount Toilet Roll Holder # KG03

Kingsway Group USA
Royal Oak, MI 48073
800-783-7980

www.kingswaygroupusa.com



400d Toilet paper holder

Ligature Resistant Toilet Paper Holder #TR740

Behavioral Safety Products
Watkinsville, GA 30677
706-705-1500

www.besafepro.com



400f. Toilet paper holder

Safety Toilet Paper Holder #C-400

Cascade Specialty Hardware, Inc.
Vancouver, WA 98660
360-823-3995

www.cascadesh.com



400h. Toilet paper holder

Suicide-Resistant Toilet Paper Dispenser

Norva Plastics, Inc.
Norfolk, VA 23508
800-826-0758

www.norvaplastics.com



410a. Undersink protection

Truebro® Lav Shield®

IPS® Corporation
Compton, CA 90220
310-898-3300

www.truebro.com



410b. Undersink protection

Undersink Enclosure #831-S27 SRTM

Weizel Security
800-308-3627

www.securingshospitals.com

Inclusion or exclusion of a product does not indicate endorsement or disapproval of that product, nor does it suggest that any product is free of risk. All products must be in compliance with the Safety Risk Assessment for each location.

10 86 00 – Security Mirrors and Domes

420a. Convex mirrors

DuraVision Quarter Dome Mirror

Norix Group, Inc.
West Chicago, IL 60185
800-234-4900
www.norix.com



12 21 13 – Horizontal Louver Blinds

430a. Aluminum window with integral blind

Storefront with hinged sash and integral blind #2450 Series

Manko Window Systems, Inc.
Manhattan, KS 66502
800-642-1488
www.mankowindows.com

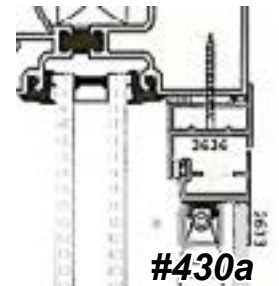

430b. Aluminum window with integral blind

Psychiatric Windows with integral blind #2187-DT

Wausau Window and Wall Systems
Wausau, WI 54401
877-678-2983
www.wausauwindow.com

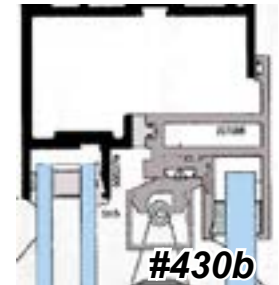

430c. Aluminum window with integral blind - removable

Medium-Security Mental Health Security Window # SS-5100

Sherwood Windows Group
Toronto, Ontario M9W 5E3
Canada
800-770- 5256
www.sherwoodwindows.com



Inclusion or exclusion of a product does not indicate endorsement or disapproval of that product, nor does it suggest that any product is free of risk. All products must be in compliance with the Safety Risk Assessment for each location.

434a. Exterior windows - ventilation

Safevent Windows

Britplas
 Woolston, Warrington WA1 4RW
 England
 +44-1925-824317
www.britplas.com



434b. Exterior windows - ventilation

Operable Security Window # SW-6300

Sherwood Windows Group
 Toronto, Ontario M9W 5E3
 Canada
 800-770-5256
www.sherwoodwindows.com



434c. Exterior windows - ventilation

512 Ventrow Ventilator

Kawneer North America
 Norcross, GA 30092
 770-449-5555
www.kawneer.com

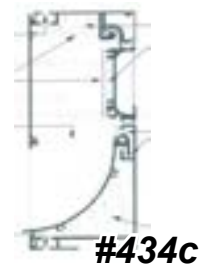

12 21 33 – Roll-Down Blinds

440a. Roller blinds

Webb Lok cordless roller shades

Inpro
 Muskego, WI 53150
 800-222-5556
<https://www.inprocorp.com/clickeze-privacy-systems/specialty-window-shades>



12 35 70 – Healthcare Case Work

460a. Cabinet pulls

Cabinet Pull # DP74C

Doug Mockett & Company, Inc.

Torrance, CA 90501

800-523-1269

www.mockett.com

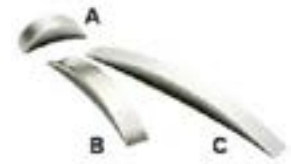

#460a

460b. Cabinet pulls

Zinc Handle – polished chrome finish #104.66.200

Hafele America Co.

Archdale, NC 27263

800-423-3531

www.hafele.com/us/en



#460b

460c. Cabinet pulls

Arc Cabinet Pull #DP18

Doug Mockett & Company, Inc.

Torrance, CA 90501

800-523-1269

www.mockett.com



#460c

465a. Cabinet locks – keyless

eLock®: Cabinet version #300 Series

CompX Security Products

847-752-2500

www.compxelock.com



#465a

465b. Cabinet locks – keyless

dialock

Hafele America Co.

800-423-3531

www.hafele.com/us/en



#465b

465c. Cabinet locks – keyless

eLock: Cabinet Version #100 Series

CompX Security Products

Mauldin, SC 29662

864-297-6655

www.compxelock.com

Inclusion or exclusion of a product does not indicate endorsement or disapproval of that product, nor does it suggest that any product is free of risk. All products must be in compliance with the Safety Risk Assessment for each location.

470a. Tamper-resistant screws

Socket Security & Torx Security

Tamperproof Screw Company, Inc.

Hicksville, NY 11801

516-931-1616

www.tamperproof.com



#470a

470b. Tamper-resistant screws

Security Pin Torx Screws and Bits

Northwest Specialty Hardware, Inc.

Clackamas, OR 97015

503-557-1881

www.northwestsh.com



#470b

12 44 16 – Shower Doors

473a. Shower doors

Wanford ShowerDoor

Safehinge-Primera

UK

0330-058-0988

www.safehingeprimera.com



473b. Shower doors

En-Suite Patient Bathroom Door w/ Shower Door**Option: #SHDUS02**

Kingsway Group USA

Royal Oak, MI 48073

800-783-7980

www.kingswaygroupusa.com



#473b

473c. Shower doors

Sentinel Event Reduction Shower Door

Norva Plastics, Inc.

Norfolk, VA 23508

800-826-0758

www.norvaplastics.com



473c

Inclusion or exclusion of a product does not indicate endorsement or disapproval of that product, nor does it suggest that any product is free of risk. All products must be in compliance with the Safety Risk Assessment for each location.

473d. Shower doors

Soft Suicide Prevention Door

Kennon Products, Inc.

Sheridan, WY 82801

307-674-6498

www.suicideproofing.com

473e. Shower door hinge

SwingHinge double action continuous hinge for SHOWER DOOR with surface cap and hinge cover plate # KG203

Kingsway Group USA

Royal Oak, MI 48073

800-783-7980

www.kingswaygroupusa.com

473e. Shower door rubber fin

Shower System Rubber Fin and mounting Section with top fixing bracket #SRF01

Kingsway Group USA

Royal Oak, MI 48073

800-783-7980

www.kingswaygroupusa.com

#473e

12 46 23 – Decorative Crafts

475. Vinyl artwork

Soft Suicide Prevention Artwork (SSPA)

Kennon Products, Inc.

Sheridan, WY 82801

307-674-6498

www.suicideproofing.com

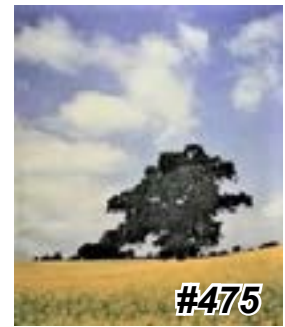

#475

476a. Ligature-resistant frames

Solid surface frames

Custom Design Frameworks

Mechanicsville, VA 23111

804-476-4233

www.customdesignframeworks.com



#476a

476b. Ligature-resistant frames

AF550 Ligature-Resistant Art Frame

Behavioral Safety Products

Watkinsville, GA 30677

706-705-1500

www.besafepro.com

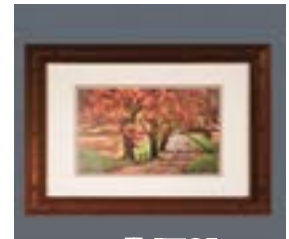

#476b

476c. Display boards

Tak-Les Bulletin Board with Guardian Frame

RAO Contract Sales, Inc.

Paterson, NJ 07501

800-445-7065

www.rao.com



#476c

12 52 70 – Healthcare Seating

479a. Stools

OFS Brands; Boost Ottoman

OFS Brands

Huntingburg, IN 47542

800-521-5381

info@ofsbrands.com



#479a

Inclusion or exclusion of a product does not indicate endorsement or disapproval of that product, nor does it suggest that any product is free of risk. All products must be in compliance with the Safety Risk Assessment for each location.

479b. Stools

Norix: Slammer Stool Series

Norix Group, Inc.
West Chicago, IL 60185
800-234-4900
www.norix.com



480a. Sand-ballasted seating

Ultra-Max Series

Norix Group, Inc.
West Chicago, IL 60185
800-234-4900
www.norix.com



480b. Sand-ballasted seating

Pineapple; Skye Plus ASKYP1-400

Pineapple Contracts
Clawson, MI 48017
800-496-9324
www.pineapplecontracts.com



480c. Sand-ballasted seating

Hardi Series Dining Chair #8701

Spec Furniture Inc.
Toronto, Ontario M9W 5B1
Canada
888-761-7732
www.specfurniture.com



481a. Lightweight seating

Integra Series chairs

Norix Group, Inc.
West Chicago, IL 60185
800-234-4900
www.norix.com



Inclusion or exclusion of a product does not indicate endorsement or disapproval of that product, nor does it suggest that any product is free of risk. All products must be in compliance with the Safety Risk Assessment for each location.

481b. Lightweight seating

RazorBack Chair

Cortech® USA
 Willowbrook, IL 60527
 800-571-0770
www.cortechusa.com



#481b

481c. Lightweight seating

Stackable chair #5000-20 Modumaxx

Moduform
 Fitchburg, MA 01420
 800-221-6638
www.moduform.com



#482e

481d. Lightweight seating

Boden Series seating

Pineapple Contracts, Inc.
 Clawson, MI 48017
 800-496-9324
www.pineapplecontracts.com



#481d

482a. Upholstered seating

Sierra Series chairs with solid arms

Norix Group, Inc.
 West Chicago, IL 60185
 800-234-4900
www.norix.com



#482a

482b. Upholstered seating

Meridian Behavioral Health Seating – chair # ML30/27BH

Nemschoff
 Sheboygan, WI 53081
 800-203-8916
www.nemschoff.com



#482g

#482b

482c. Upholstered seating

Wink Series Chair

Norix Group, Inc.
 West Chicago, IL 60185
 800-234-4900
www.norix.com



#482c

Inclusion or exclusion of a product does not indicate endorsement or disapproval of that product, nor does it suggest that any product is free of risk. All products must be in compliance with the Safety Risk Assessment for each location.

482d. Upholstered seating

Endurance Series

Blockhouse Company, Inc.
York, PA 17406
800-346-1126
www.blockhouse.com



#482d

482e. Upholstered seating

Dignity Series #4501M

Spec Furniture Inc.
Toronto, Ontario M9W 5B1
Canada
888-761-7732
www.specfurniture.com



482f. Upholstered seating

Carrara

Kwalu
Atlanta, GA 30328
877-695-9258
www.kwalu.com



#482f

482g. Upholstered seating

Arcadia Series

Blockhouse Company, Inc.
York, PA 17406
800-346-1126
www.blockhouse.com



482h. Upholstered seating

Sierra Series chairs with open arms

Norix Group, Inc.
West Chicago, IL 60185
800-234-4900
www.norix.com



#482h

Inclusion or exclusion of a product does not indicate endorsement or disapproval of that product, nor does it suggest that any product is free of risk. All products must be in compliance with the Safety Risk Assessment for each location.

482i. Upholstered seating

Skye Plus ASKYP1-400

Pineapple Contracts, Inc.

Clawson, MI 48017

800-496-9324

www.pineapplecontracts.com



482j. Upholstered seating

Domus Lounge Seating

Pineapple Contracts, Inc.

Clawson, MI 48017

800-496-9324

www.pineapplecontracts.com



482k. Upholstered seating

Chaise Lounge Chair

Blockhouse Company, Inc.

York, PA 17406

800-346-1126

www.blockhouse.com



483a. Rockers

RockSmart

Norix Group, Inc.

West Chicago, IL 60185

800-234-4900

www.norix.com



483b. Rockers

Hardi Rocking Chair

Spec Furniture

888-761-7732

specfurniture.com



Inclusion or exclusion of a product does not indicate endorsement or disapproval of that product, nor does it suggest that any product is free of risk. All products must be in compliance with the Safety Risk Assessment for each location.

483c. Rockers

Endurance Series Rocker

Blockhouse Company, Inc.
 York, PA 17406
 800-346-1126
www.blockhouse.com

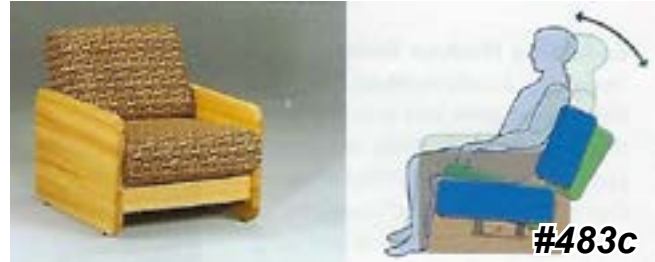

484a. PVC molded seating

Forté™ Lounge

Norix Group, Inc.
 West Chicago, IL 60185
 800-234-4900
www.norix.com



484d. PVC molded seating

Hondo® Nuevo

Norix Group, Inc.
 West Chicago, IL 60185
 800-234-4900
www.norix.com



12 56 70 – Healthcare Furniture

485a. Tables

Jupiter Series Tables

Norix Group, Inc.
 West Chicago, IL 60185
 800-234-4900
www.norix.com



485b. Tables

Madera Series Tables

Norix Group, Inc.
West Chicago, IL 60185
800-234-4900
www.norix.com



#485b

485c. Tables

Tabla Series Drum Tables

Norix Group, Inc.
West Chicago, IL 60185
800-234-4900
www.norix.com



#485c

490a. Electrically adjustable hospital bed

Behavioral Health Bed™

Sizewise
Lenexa, KS 66215
800-814-9389
www.sizewise.com



#490a

490b. Electrically adjustable hospital bed

Spirit Bed with Mental Health Package

CHG Hospital Beds
London, ON N6E 1R6
Canada
866-516-5446
www.chgbeds.com



#490b

490c. Electrically adjustable hospital bed

MedSurg Bed #S3

Stryker
Kalamazoo, MI 49002
269-385-2600
www.stryker.com



#490c

Inclusion or exclusion of a product does not indicate endorsement or disapproval of that product, nor does it suggest that any product is free of risk. All products must be in compliance with the Safety Risk Assessment for each location.

490d. Electrically adjustable hospital bed

Mental Health Electric Bed

Umano Medical, Inc.
G0R 2Co, Canada
1-844-409-4030

www.umanomedical.com



#490d

491a. Bedding

One Piece Comfort and Safety Linen

Harm Reduction Solutions
San Diego, CA 92117
858-500-2110

www.harmreductionsolutions.com



#491a

492a. Behavioral health mattresses

Comfort Shield® Remedy Sealed Seam Mattress

Norix Group, Inc.
West Chicago, IL 60185
800-234-4900

www.norix.com

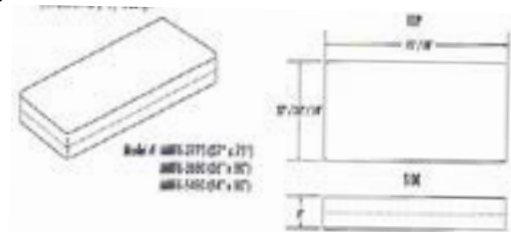

#492a

492b. Behavioral Health Mattresses

Victory Series Mattresses

Sizewise
Lenexa, KS 66215 800-814-9389

www.sizewise.net

492c. Behavioral health mattresses

**Behavioral Health Mattress with Bed Bug Protection
BioArmour™ Infection Control Composite Lamina
Surface**

American Innovation Products
Trinity, NC 27370
814-490-0660

www.americaninnovationproducts.com



#492c

Inclusion or exclusion of a product does not indicate endorsement or disapproval of that product, nor does it suggest that any product is free of risk. All products must be in compliance with the Safety Risk Assessment for each location.

492d. Behavioral health mattresses

Closed System™ Behavioral Health Mattress

Comfortex®

Winona, MN 55987

800-445-4007

www.comfortexinc.com

493a. Platform bed

Attenda Series Roto Cast Bed

Norix Group, Inc.

West Chicago, IL 60185

800-234-4900

www.norix.com

#493a

493d. Platform bed

Behavioral Health Beds # BHBP/68 and BHHD/68

Nemschoff

Sheboygan, WI 53081

800-203-8916

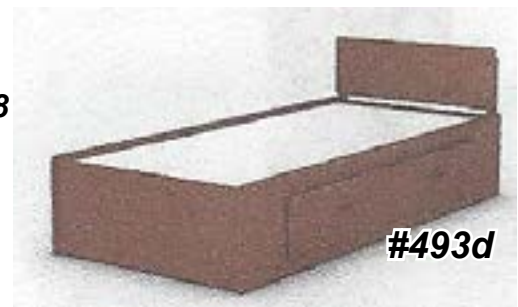
www.nemschoff.com

#493d

493e. Platform bed

Pineapple; Sovie Bed 1SVFA-100

Pineapple Contracts, Inc.

Clawson, MI 48017

800-496-9324

www.pineapplecontracts.com

493g. Platform bed

Behavioral Health Bed™ - Platform

Sizewise

Lenexa, KS 66215

800-814-9389

www.sizewise.com

#493g

Inclusion or exclusion of a product does not indicate endorsement or disapproval of that product, nor does it suggest that any product is free of risk. All products must be in compliance with the Safety Risk Assessment for each location.

493h. Platform bed

Frontier bed

Stance Healthcare
 Kitchener, ON N2C 0B8
 877-395-2623
www.stancehealthcare.com



#493h

494a. Platform bed – lift-accessible

Sleigh Bed

Norix Group, Inc.
 West Chicago, IL 60185
 800-234-4900
www.norix.com



#494a

494b. Platform bed riser – lift-accessible

Platform Bed Riser

Norix Group, Inc.
 West Chicago, IL 60185
 800-234-4900
www.norix.com



#494b

495a. Patient room furniture

VISTA Series

Blockhouse Company, Inc.
 York, PA 17406
 800-346-1126
www.blockhouse.com



#495a

495b. Patient room furniture

Safehouse Series

Norix Group, Inc.
 West Chicago, IL 60185
 800-234-4900
www.norix.com



#495b

Inclusion or exclusion of a product does not indicate endorsement or disapproval of that product, nor does it suggest that any product is free of risk. All products must be in compliance with the Safety Risk Assessment for each location.

495c. Patient room furniture

Safe & Tough series

This End Up® Furniture Company, Inc.
 Sanford, NC 27331
 800-605-2130
www.thisendup.com/groupliving.com



#495c

495d. Patient room furniture

Endurance Series

Cortech® USA
 Willowbrook, IL 60527
 800-571-0770
www.cortechusa.com



#495d

495e. Patient room furniture

Attenda Series

Norix Group, Inc.
 West Chicago, IL 60185
 800-234-4900
www.norix.com



#495e

496a. Patient room cabinets

Fortress Wardrobes

Moduform
 Fitchburg, MA 01420
 800-221-6638
www.moduform.com



496b

496b. Patient Room cabinets

Frontier bedside cabinet – flip style

Stance Healthcare
 Kitchener, ON N2C 0B8
 877-395-2623
www.stancehealthcare.com



#496e

Inclusion or exclusion of a product does not indicate endorsement or disapproval of that product, nor does it suggest that any product is free of risk. All products must be in compliance with the Safety Risk Assessment for each location.

496c. Patient Room cabinets

CPAP Cabinet

Blockhouse Company, Inc.

York, PA 17406

800-346-1126

www.blockhouse.com

#496c

497a. Restraint bed

450 Series Seclusion Beds (restraint loops optional)

Moduform

Fitchburg, MA 01420

800-221-6638

www.moduform.com

#497a

497b. Restraint bed

Duraguard bed with side bars

Glasspec Corporation

Miami, FL 33256-0116

800-328-0888

www.glasspec.com

#497b

498a. Removable Restraint Loops

Attenda Restraint Rings (for use with Attenda beds)

Norix Group, Inc.

West Chicago, IL 60185

800-234-4900

www.norix.com

#498a

498b. Removable Restraint Loops

Restraint Adapter and Buckle System

SydLo Design LLC

South Range, Wisconsin

218-310-4351

SydLoDesignLLC.com

#498b

Inclusion or exclusion of a product does not indicate endorsement or disapproval of that product, nor does it suggest that any product is free of risk. All products must be in compliance with the Safety Risk Assessment for each location.

499a. Nurse servers

WALLAroo®

Carstens®, Inc.
Chicago, IL 60706
800-782-1524
www.carstens.com



499b. Nurse servers

Proximity EXT-28

Proximity Systems
800-437-8111
www.proximiiitysystems.com



12 93 43 – Site Furnishings - Seating and Tables

510. Outdoor Furniture

Hilltop Outdoor Furniture

Norix Group, Inc.
West Chicago, IL 60185
1-800-234-4900
www.norix.com



21 00 00 - Fire Suppression

21 13 13 - Fire Suppression Sprinkler Systems

520a. Fire sprinklers

Raven 5.6K Institutional Sprinklers

TYCO Fire Protection Products
Lansdale, PA 19446
800-523-6512
www.tyco-fire.com



520b. Fire sprinklers

819-S17 SR Sprinkler

Weizel Security
800-308-3627
www.securinhospitals.com

#520a

Inclusion or exclusion of a product does not indicate endorsement or disapproval of that product, nor does it suggest that any product is free of risk. All products must be in compliance with the Safety Risk Assessment for each location.

- 521a. Fire extinguisher cabinet
BestCare® Ligature-Resistant Recessed Fire Extinguisher Cabinet WH1704
 Whitehall Manufacturing
 City of Industry, CA 91744-0527
 800-782-7706
www.whitehallmfg.com



22 43 00 – Plumbing Fixtures

22 43 13 – Healthcare Water Closets

531. Toilet fixture, ADA–floor-mounted, back outlet
Huron EverClean Flushometer Toilet with integral seat
 American Standard
 Piscataway, NJ 08855
 800-488-8049
www.americanstandard-us.com



533. Solid-surface toilet fixture
CWC-156 AST-FF Behavioral HealthCare Toilet
 Intersan Manufacturing Company
 Phoenix, AZ 85007
 602-254-3101
www.intersan.us



- 534a. Stainless steel toilet
ETW-1490 Series
 Willoughby Industries
 Indianapolis, IN 46268
 800-428-4065
www.willoughby-ind.com



Inclusion or exclusion of a product does not indicate endorsement or disapproval of that product, nor does it suggest that any product is free of risk. All products must be in compliance with the Safety Risk Assessment for each location.

534b. Toilet fixture – stainless steel

BestCare® Ligature-Resistant Toilet, Wall Supply, WH2142-W

Whitehall Manufacturing
City of Industry, CA 91744
800-782-7706
www.whitehallmfg.com



#534b

536. Bariatric toilet fixtures

BET-1490 Series – Bariatric toilets

Willoughby Industries
Indianapolis, IN 46268
800-428-4065
www.willoughby-ind.com



#536

22 43 16 – Healthcare Sinks

540a. Wall-Hung Corner Lavatories

BestCare® Ligature-Resistant, ADA Compliant Corterra Cast Solid Surface Corner Basin; WH3776 Series

Whitehall Manufacturing
City of Industry, CA 91744-0527
800-782-7706
www.whitehallmfg.com



#540a

541a. Wall-Hung Lavatories

HSL1 SafeCare Ligature-Resistant Lavatory – stainless steel or high- impact polymer trap cover

Bradley Corporation
Menomonee Falls, WI 53051
800-272-3539
www.bradleycorp.com



#541a

542a. Vanity top lavatory

Suicide Prevention Patient Sink Faucet

Norva Plastics, Inc
Norfolk, VA 23508
800-826-0758
www.norvaplastics.com



#542a

Inclusion or exclusion of a product does not indicate endorsement or disapproval of that product, nor does it suggest that any product is free of risk. All products must be in compliance with the Safety Risk Assessment for each location.

542b. Vanity top lavatory

Avonite® Acrylic Solid Surfaces

Avonite Surfaces
Florence, KY 41042
800-354-9858
www.avonite.com

545. Hand Washing

Wallgate; Thrii (soap, water, drying)

Intersan Manufacturing Company
Phoenix, AZ 85007
602-254-3101
www.intersan.us



#545

22 43 19 – Healthcare Bathtubs and Showers

550a. Shower head – ligature resistant

SP-7 Shower Head

Odd Ball Industries Mfg. Co., Inc.
Greenlawn, NY 11740
631-754-0400
www.oddballindustries.com



#545

550c. Shower head – ligature resistant

Ligature-Resistant Shower Head – SH330

Behavioral Safety Products
Watkinsville, GA 30677
706-705-1500
www.besafepro.com



#550a

552a. Shower Control Valve



#550c

Inclusion or exclusion of a product does not indicate endorsement or disapproval of that product, nor does it suggest that any product is free of risk. All products must be in compliance with the Safety Risk Assessment for each location.

WH538-CSH Ligature-Resistant Shower Head and Valve

Whitehall Manufacturing
City of Industry, CA 91744-0527
800-782-7706
www.whitehallmfg.com



#563c

552b. Shower valve

Ligature-Resistant Shower Valve – SV230

Behavioral Safety Products
Watkinsville, GA 30677
706-705-1500
www.besafepro.com



#552b

552c. Shower valve

834-S40 SRTM Retrofit Shower Knob

Weizel Security
800-308-3627
www.securingshospitals.com



#552c

552d. Shower valve

Sense™ DMV2 – Individual Shower concealed electronic mixing valve with optional stainless steel cover

Armstrong International
Three Rivers, MI 49093
269-273-1415
www.armstronginternational.com



#552d

555a. Shower diverter valve

834-SN2 SRTM Diverter Valve Assembly

Weizel Security
800-308-3627
www.securingshospitals.com



#555a

Inclusion or exclusion of a product does not indicate endorsement or disapproval of that product, nor does it suggest that any product is free of risk. All products must be in compliance with the Safety Risk Assessment for each location.

560a. Shower assembly

BestCare® Flush-Mount Ligature-Resistant Security Shower WH1741-CSH

Whitehall Manufacturing
 City of Industry, CA 91744-0527
 800-782-7706
www.whitehallmfg.com

#560a



560b. Shower assembly

SR834-S35 SRTM Shower Panel

Weizel Security
 800-308-3627
www.securingshospitals.com

#560b



560c. Shower assembly

Ligature-Resistant Shower Panel #SV710

Behavioral Safety Products
 Watkinsville, GA 30677
 706-705-1500
www.besafepro.com

#560c



562. Shower assembly – recessed hand-held

M0418-E508 in locking box

Acorn Engineering
 City of Industry, CA 91746
 800-488-8999
www.acorneng.com

#562

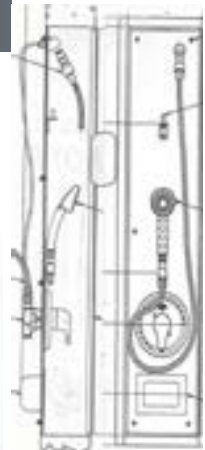

563a. Shower assembly – handicapped accessible

Dual Quick Connect – Wall Mounted Shower Head with Integral Diverter #42020US

Intersan Manufacturing Company
 Phoenix, AZ 85007
 602-254-3101
www.intersan.us

#563a



563b. Shower assembly – handicapped accessible

Quick release hand held shower head; Model 40707

Intersan Manufacturing Company

Phoenix, AZ 85007

800-999-3101

www.intersanus.com



563c. Shower assembly – handicapped accessible

BestCare® Flush-Mount Ligature-Resistant Security Shower with Dual Heads WH1741-FH-CSH

Whitehall Manufacturing

City of Industry, CA 91744-0527

800-782-7706

www.whitehallmfg.com

#563c



22 43 23 – Shower Receptors and Basins

564a. Shower linear drain

ProLine drain with “dots” cover

QuickDrain USA

Frisco, CO 80443

866-998-6685

www.quickdrainusa.com

#563c



#564a

565a. Ligature Resistant Drain Cover

Crocodile Roll Resistant Floor Drain; 303070X

Intersan Manufacturing Company

Phoenix, AZ 85007

800-999-3101

www.intersanus.com



#565a

565b. Ligature Resistant Drain Cover

Tower Industries; Anti-Ligature Drain Cover – Model SDC-AL-1-S

Tower Industries

Massillon, OH 44647

330-837-2216

www.towershowers.com



#565b

Inclusion or exclusion of a product does not indicate endorsement or disapproval of that product, nor does it suggest that any product is free of risk. All products must be in compliance with the Safety Risk Assessment for each location.

565c. Ligature Resistant Drain Cover

BestCare® Ligature-Resistant Floor Drain Grate WHDG Series

Whitehall Manufacturing
 City of Industry, CA 91746
 800-782-7706
www.whitehallmfg.com



565d. Ligature Resistant Drain Cover

BestCare® Ligature-Resistant Linear Drain with Flashing Flange WHLD Series

Whitehall Manufacturing
 City of Industry, CA 91746
 800-782-7706
www.whitehallmfg.com



566. One-piece patient toilet room floor

UniFloor

Bestbath®
 Caldwell, ID 83605
 800-727-9907
www.bestbath.com



567a. Shower floor basin

The Swan Corporation, Swanstone Solid Surface Shower Floors

The Swan Corporation
 St. Louis, MO. 63101
 1-314-231-8148
www.theswancorp.com



567b. Shower floor basin

Roll-in shower with front trench

Watermark
 Nashville, TN 37204
 615-291-6111
www.watermarksolidsurface.com



567c. Shower floor basin

AquaSurf solid surface shower bases

Willoughby Industries
Indianapolis, IN 46268
800-428-4065

www.willoughby-ind.com



#567c

568a. Pre-built bathrooms

Pre-Built Bathrooms

Eggrock, LLC
Littleton, MA 01460
978-952-8800

www.eggrock.com



#568a

568b. Pre-built bathrooms

SurePods™

Oldcastle®
Orlando, FL 32837
407-859-7034

<https://oldcastlesurepods.com>

22 43 39 – Healthcare Faucets

570a. Lavatory faucet

Ligature-Resistant Metering Faucet – SF380

Behavioral Safety Products
Watkinsville, GA 30677
706-705-1500

www.besafepro.com



#570a

570b. Lavatory faucet

Suicide Prevention Patient Sink Faucet

Norva Plastics, Inc
Norfolk, VA 23508
800-826-0758

www.norvaplastics.com



#570b

570c. Lavatory faucet

**BestCare® Ligature-resistant, ADA-compliant faucet
3377 w/2 pneumatic buttons**

Whitehall Manufacturing
City of Industry, CA 91744-0527
800-782-7706
www.whitehallmfg.com



3570c

570d. Lavatory faucet

**BestCare® Ligature-resistant, ADA-compliant Sensor
faucet #WH3375-SO**

Whitehall Manufacturing
City of Industry, CA 91744-0527
800-782-7706
www.whitehallmfg.com



#570d

574. Lavatory with countertop valve

Lavatory Valve

Odd Ball Industries
Greenlawn, NY 11740
631-754-0400
www.oddballindustries.com



#574

22 43 43 – Plumbing Fixture Flushometers

580. Recessed flush valve

Royal 611 & WB-1-A Easy Access Wall Box

Sloan®
Franklin Park, IL 60131
800-982-5839
www.sloan.com



#580

581a. Recessed flush valve

**Regal 955 Hydraulic Concealed Flushometer & WB-1-A
Easy Access Wall Box**

Sloan®
Franklin Park, IL 60131
800-982-5839
www.sloan.com



#581a

581b. Recessed flush valve

CX Manual Flushometer (Recessed)

Sloan®

Franklin Park, IL 60131

800-982-5839

www.sloan.com



#581b

581c. Recessed flush valve

3-inch Push Button Assembly for Concealed Flush Valves – P6000-NL3

Zurn Industries

Milwaukee, WI 53204

855-663-9876

www.zurn.com



#585a

585a. Flush valve cover

HSC79 SafeCare Ligature-Resistant Flush Valve Cover

Bradley Corporation

W142N9101 Fountain Boulevard Menomonee Falls, WI 53051

800-272-3539

www.bradleycorp.com

585b. Flush valve cover

FV500 (2 piece) & FV600 (1 piece) Ligature Resistant Flush Valve Cover

Behavioral Safety Products

Watkinsville, GA 30677

706-705-1500

www.besafepro.com



#585b

585c. Flush valve cover

831-S39 SRTM Flush Valve Cover

Weizel Security

Coquitlam, BC, Canada V3K 6V5

800-308-3627

www.securingshospitals.com



#585c

585d. Flush valve cover

Ligature-Resistant Box with Flush Valve WH2802 – for various toilet or urinal

Whitehall Manufacturing
City of Industry, CA 91744-0527
800-782-7706
www.whitehallmfg.com



588. Recessed bedpan washer

Recessed Bedpan Washer

Willoughby Industries
Indianapolis, IN 46268
800-428-4065
www.willoughby-ind.com

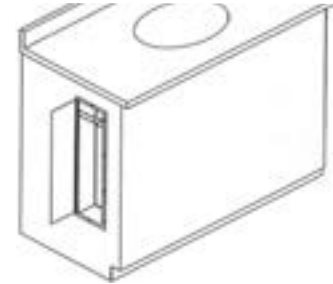

#588

22 47 00 – Water Station Water Coolers

589a. Drinking water cup filling stations

B103-C2-HR Water Bottle Filling Station Cup Dispenser and Disposal with security features

Filtrine Manufacturing Company
Keene, NH 03431
800-930-3367
www.filtrine.com



#589a

589b. Drinking water cup filling stations

Quench 755 Countertop Filtered Water Cooler with UV

Quench
King of Prussia, PA 19406
888-877-0561
www.quenchonline.com



#589b

589c. Drinking water cup filling stations

Pushbutton Ligature-Resistant Cup Filler – WHBF3

Whitehall Manufacturing
City of Industry, CA 91744-0527
800-782-7706
www.whitehallmfg.com



22 60 00 – Gas and Vacuum Systems

590a. Medical gas covers

Security Patient Console

Hospital Systems, Inc.
Pittsburg, CA 94565
925-427-7800
www.hsiheadwalls.com



590b. Medical gas covers

Recessed Security Console

Modular Services Company
Oklahoma City, OK 73114
800-687-0938
www.modularservices.com/products-services/



590c. Medical gas covers

Security Headwalls w/ 3/8" polycarbonate locked cover bottom hinge

Modular Services Company
Oklahoma City, OK 73114
800-687-0938
www.modularservices.com
www.filtrine.com



23 00 00 – Heating, Ventilating, A/C

23 37 13 – Diffusers, Registers and Grilles

600a. Air grille - “S” vane

Security Grille – “S” vane # RSPA41

Carnes® Company

Verona, WI 53593

608-845-6411

www.carnes.com

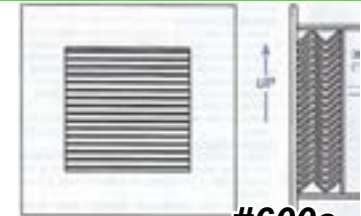

#600a

600c. Air grille - “S” vane

V-Vent High Security Grille #814-R17 SRTM

Weizel Security

800-308-3627

www.securingshospitals.com

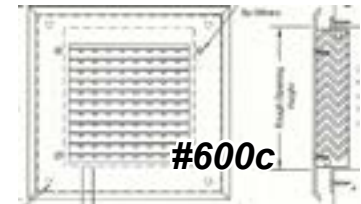

#600c

600d. Air grille - “S” vane

Maximum Security Ceiling Diffuser # SSV432

Anemostat® Air Distribution

Carson, CA. 90745

310-835-7500

www.anemostat.com

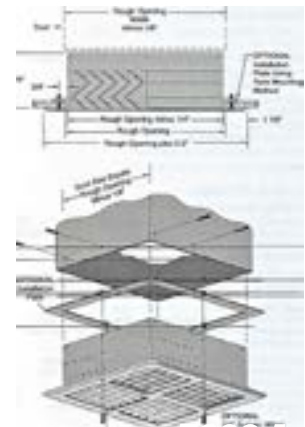

#600d

602a. Air grille – max security

Extra Heavy Duty Grille with Removable Steel Perforated Face Plate # RRMX

Anemostat® Air Distribution

Carson, CA. 90745

310-835-7500

www.anemostat.com



#602a

602b. Air grille – max security

Maximum Security Suicide Deterrent Grille, steel with 3/16-inch holes # SG-SD

Titus

Plano, TX 75074

972-212-4800

www.titus-hvac.com



603a. Air grilles - Perforated

Security Grille – Perforated # RSPA51

Carnes® Company

Verona, WI 53593

608-845-6411

www.carnes.com



603b. Air grilles - Perforated

Security Grille – supply or return # SEG-4P3

Kees Incorporated

Elkhart Lake, WI 53020-0327

920-876-3391

www.kees.com

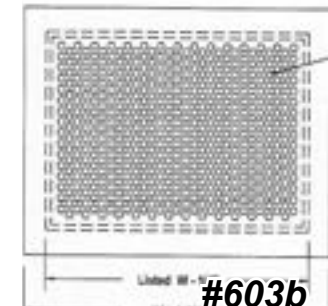

603c. Air grilles - Perforated

Ligature-Resistant Exhaust/Supply Grille #EG450

Behavioral Safety Products

Watkinsville, GA 30677

706-705-1500

www.besafepro.com



#603c

606a. Fan coil enclosures

Fan Coil Covers - Security

ARSCO Manufacturing Company

Cincinnati, OH 45248

800-543-7040

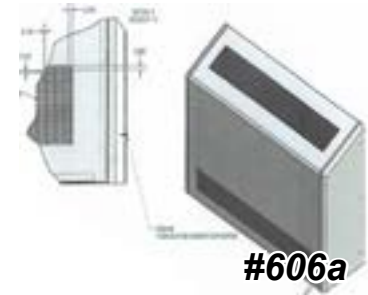
www.arscomfg.com

#606a

609b. Air grilles - Perforated

Ligature-Resistant PTAC Cover #TA460

Behavioral Safety Products

Watkinsville, GA 30677

706-705-1500

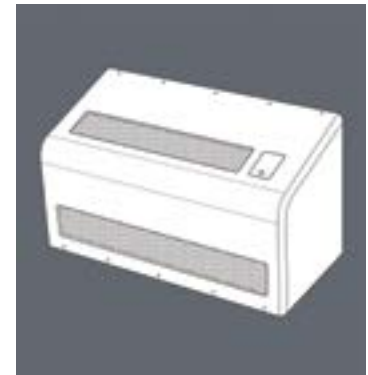
www.besafepro.com

609b

607a. Room Temperature Sensor – tamper-resistant

Flush-Mount Thermistor; KTP Series Stainless Steel

Kele, Inc.

Bartlett, TN 38133

877-826-9045

www.kele.com

#607a

607b. Room Temperature Sensor – tamper-resistant

Flush-Mount Room Temperature Sensor #540-520

Siemens Building Technologies, Inc.

1000 Deerfield Parkway

Buffalo Grove, IL 60089

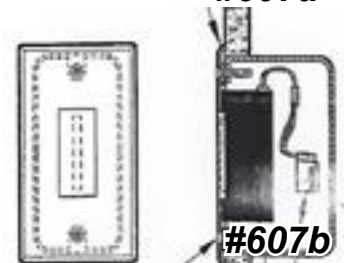
www.siemens.com

#607b

26 27 26 – Electrical Devices

610a. Hospital-grade receptacles

Hospital Grade Tamper-Resistant GFCI Receptacles

Hubbell Incorporated

Shelton, CT 06484

800-288-6000

www.hubbell-wiring.com



#610a

610b. Hospital-grade receptacles

Hospital Grade Tamper-Resistant GFCI Receptacles

Cooper Industries

Houston, TX 77210-4446

713-209-8400

www.cooperindustries.com



#611a

611a. Key-operated electric switches

Pass & Seymour Locking Keyed Switch

Legrand North America, LLC

<http://www.legrand.us/passandseymour.aspx>



#611b

611b. Key-operated electric switches

Leviton 1221-2KL Key Locking Extra Heavy Duty Switch

Leviton Manufacturing Co., Inc.

www.leviton.com



#612a

612a. Polycarbonate electrical coverplates

Tiger Plates

Cortech® USA

Willowbrook, IL 60527

800-571-0700

www.cortechusa.com

26 51 00 – Interior Lighting

620a. Light fixture

NASL-RND LED 2' diameter w/ flat polycarbonate lens Day-O-Lite

Warwick, RI 02888

401-467-8232

www.dayolite.com

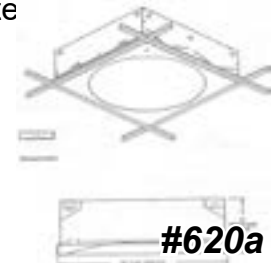

620b. Individual reading light

Symmetry tamper-resistant light fixture

Visa Lighting

Milwaukee, WI 53209

www.visalighting.com



620c. Light fixture

Fino® ceiling mount and wall mount light fixtures

Amerlux®, LLC

Oakland, NJ 07436

973-882-5010

www.amerlux.com

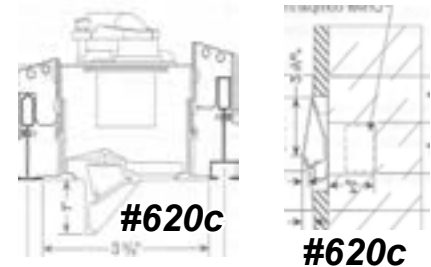

620d. Light fixture

Mighty Mac TW Series TUNABLE Color SSA Slope Sided Surface Mount or RMCD Recessed Mount vandal resistant light fixtures

Kenall®

Kenosha, WI 53144

800-453-6255

www.kenall.com



620e. Light fixture

Fail-Safe SGI recessed, sealed, and gasketed with polycarbonate lens

Eaton's Cooper Lighting

Peachtree City, GA 30269

770-486-4800

www.cooperindustries.com



620f. Light fixture

818-R13 SRTM Recessed Ceiling Lighting with polycarbonate lens

Weizel Security

800-308-3627

www.securingshospitals.com



620g. Light fixture

Serenity Series

Visa Lighting

Milwaukee, WI 53209

800-788-8472

www.visalighting.com



620h. Light fixture

Ligature and Vandal-Resistant 6" LED downlight #MRV-0685

Kirlin Company

Detroit, MI 48207

313-259-6400

www.kirlinlighting.com



620j. Light fixture

Sonar 12 SPC12 Vandal Resistant wall mount fixture

Luminaire Lighting Corporation

P. O. Box 2162

Edison, NJ 08818

732-549-0056

www.luminairerlighting.com



620k. Light fixture

Shat-R-Shield - Ironclad VR Pro surface mounted vandal-resistant fixture #494F12

Grainger

Lake Forest, IL 60045

800-472-4643

www.grainger.com



620l. Light fixture

**Vandal Resistant round wall/ceiling mount fixture
Anyx-13, ARV-13**

Luminaire Lighting Corporation
Edison, NJ 08818
732-549-0056
www.luminairelighting.com



620m. Light fixture

Kenall MedMaster MedSlot Series

Kenall®
Kenosha, WI 53144
800-453-6255
www.kenall.com

620n. Light fixture

Fail-Safe FW WaveStream Wall LED Luminaire

Eaton Lighting
770-486-4800
www.eaton.com/lighting



624. Individual reading light

Visa Lighting; Gig with BH1 mounting bracket & polycarbonate lens

Visa Lighting
Milwaukee, WI 53209
800-788-8472
www.visalighting.com



630. Downlight cover

Recesso Lights

Recesso Lighting by Dolan Designs
Kirkland, WA 98034
877-357-6127
<http://recessolighting.com>



637. Exterior lighting

Exterior Vandal Resistant Lighting

The Kirlin Company

Detroit, MI 48207

313-259-6400

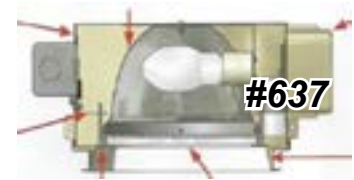
www.kirlinlighting.com

639a. Night-light

LNT-03092 Night Light

The Kirlin Company

Detroit, MI 48207

313-259-6400

www.kirlinlighting.com

639b. Night-light

CM-25500 PathMaster Step Light

Phillips Lighting North America Corp.

(Chloride)

Somerset, NJ 08873

855-486-2216

www.lightingproducts.phillips.com

26 53 00 – Exit Signs

640a. Exit signs, LED – vandal-resistant

Commercial Exist Signs SC Series – Cast Aluminum LED with lens and tamperproof hardware

Philips Lighting North America Corporation (Chloride)

Somerset, NJ 08873

855-486-2216

www.lightingproducts.philips.com

640b. Exit signs, lighted – vandal-resistant

Mighty Mac MMEX Surface, Wall, or Ceiling Mount Single/Dc full-length mounting canopy

Kenall®

Kenosha, WI 53144

800-453-6255

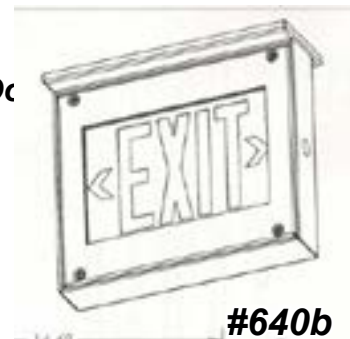
www.kenall.com

642. Exit signs - photoluminescent

EX424246-100G Ecoglo® Photoluminescent Exit Sign

Access Products Inc.
Buffalo, NY 14203
888-679-4022
www.us.ecoglo.com

26 55 53 – Security Lighting

643. Covers

Norva Plastics – Life/Fire Safety Lexan Covers

Norva Plastics, Inc
Norfolk, VA 23508
800-826-0758
www.norvaplastics.com



27 00 00 – Communications

27 32 13 – Telephone Sets

645a. Stainless steel wall phones

GB306V-14 Vandal-Resistant Telephone with 14” armored cord

Allen Tel Products, Inc.
Henderson, NV 89014
702-855-5700
www.allentel.com



645b. Stainless steel wall phones

SSW-321-X Ceeco Stainless Steel Wall Phone

TWAcomm.com
Fountain Valley, CA 92708
877-389-0000
www.twacomm.com



645c. Stainless steel wall phones

JP3500 Armored Courtesy Phone

G-Tel Enterprises, Inc.

Houston, TX 77084

800-884-4835

www.payphone.com



#645c

27 52 23 – Nurse Call/Code Blue Systems

650a. Wireless duress alarm

INSTANTalarm® 5000

Pinpoint®, Inc.

Birmingham, AL 35209

205-414-7541

www.pinpointinc.com



#650a

650f. Wireless duress alarm

B3000n Communication Badge

Vocera®

San Jose, CA 95126

888-986-2372

www.vocera.com



#650f

653. Nurse call system – vandal-resistant

HSS401 Responder Health Care Communications System High Security Staff Duty Station

Rauland-Borg Corporation

Mount Prospect, IL 60056

800-752-7725

www.rauland.com

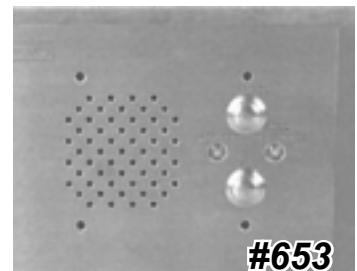

#653

654. Pushbutton switch – vandal-resistant

PV1-PV8 Anti-Vandal Switches

Lamb Industries
 Minneapolis, MN 55428
 800-867-2717
<http://www.e-switch.com/>



#654

28 00 00 – Electronic Safety and Security

28 40 00 – Electronic Monitoring and Control

660. Metal Detectors

Metrasens; Proscreen 200

Metrasens
 Lisle, IL 60532
 630-541-6509
<http://www.metrasens.com/>



#660

32 00 00 – Exterior Improvements

32 31 13 – Security Fencing

675a. Security fencing

Mini-Mesh chain-link fencing

Fence Factory
 Agoura Hills, CA 91301
 800-613-3623
www.fencefactory.com



#675a

675b. Security fencing

WireWall® High Security Fencing - Maximum Security

Riverdale Mills Corporation
 Northbridge, MA 01534
 800-762-6374
www.riverdale.com



#675b

675c. Security fencing

Steel fence systems

METALCO Fence & Railing Systems, Inc.

Las Vegas, NV 89102

800-708-2526

fence-system.com



675d. Security fencing

Fortress Fencing

Britplas

Woolston

Warrington, Cheshire, England WA1 4RW

+44(01)-1925-824317

www.britplas.com



About the Authors

James M. Hunt, AIA, is a practicing architect and facility management professional with more than 40 years of experience. He is a registered architect and began his career practicing architecture for several major health care projects. He then served as director of facility management for the Menninger Clinic for 20 years. In addition to managing the clinic's main campus, he consulted on behavioral health care unit remodeling projects for their Clinical Network program in eight states. During this time, Mr. Hunt was a founding member of the Health Care Council of the International Facility Management Association. He held several offices in the council, including chair. He publishes articles and speaks at major conferences frequently. He is founder and Senior Consultant of Behavioral Health Facility Consulting, LLC (BHFC), an organization that consults with behavioral health organizations and architects who design behavioral health facilities regarding their unique requirements for patient and staff safety. He has worked with behavioral health facilities in more than 40 years and may be reached at www.bhfcllc.com.

David M. Sine, DrBE, CSP, ARM, CPHRM - 25 years in safety, risk management, human factors, and organizational consulting. He has been state safety director of two eastern states, senior staff engineer for the Joint Commission, and a senior consultant for the American Hospital Association. Founding partner and one-time contributing editor for Briefings on Hospital Safety, co-author of Quality Improvement Techniques for Hospital Safety, and one-time vice chair of the board of Brackenridge Hospital in Austin, Texas, Mr. Sine is certified by the Joint Board of the American Board of Industrial Hygiene and Certified Safety Professionals and as a Certified Professional Healthcare Risk Manager by ASHRM. He has been a health care risk management consultant since 1980 and has conducted more than 1,300 Joint Commission compliance assessment surveys. He serves as a member of the NFPA 101 Life Safety Code Subcommittee on Health Care Occupancies, the Joint Commission Committee on Healthcare Safety, and the FGI Health FGI Guidelines Revision Committee and acts as a risk management adviser to the National Association of Psychiatric Health Systems. He served in the corporate offices of the Tenet Health System in Dallas as director of risk assessment and loss prevention and vice president of occupational health and safety. Mr. Sine continues to write and lecture extensively on health care policy, governance, quality improvement, and risk management as President of SafetyLogic Systems. He can be reached at dsine9@gmail.com.

Kimberly Newton McMurray, AIA, EDAC, MBA is Principal of Behavioral Health Facility Consulting, LLC. of Tuscaloosa, Alabama. McMurray is a practicing architect and healthcare planner with 32 years of leadership experience in healthcare and academic medical campus architecture; she has been responsible for the implementation of large architectural projects located within complex medical campus sites, delivering the highest quality for each project initiative. McMurray has a decade of experience from the owner's perspective and working with multi-disciplinary user groups, thereby embracing a unique perspective and response to client needs; applying her knowledge of clinical operations, evidence-based design, lean operational planning and conceptual design to architecture. Among McMurray's three decades of healthcare architectural expertise, she brings a high-level of experience with behavioral health project types. During her experience on-staff architect at The University of Alabama at Birmingham (UAB) Health System Center for Psychiatric Medicine, and development of the Psychiatric Treatment Unit for the UAB Emergency Services department. She has assisted 26 behavioral health facilities since joining BHFC in 2017. She can be reached at kimberly@bhfcllc.com.

This document is intended to represent leading current practices, in the opinion of the authors. It does not represent minimum acceptable conditions or establish a legal "standard of care" that facilities are required to follow.

List of Manufacturers

Access Products, www.us.ecoglo.com	Big John, www.bigjohntoiletseat.com
Accurate, www accuratelockandhardware.com	Blockhouse, www.blockhouse.com
Ace Security, www.smashandgrab.com	Bradley, www.bradleycorp.com
Acorn Engineering Co., www.acorneng.com	Brey-Krause www.breykrause.com
Allen Tel Products, www.allentel.com	Britplas, www.britplas.com
Alro Plastics, www.alro.com	Carnes, www.carnes.com
American Innovation, www.americaninnovationproducts.com	Carstens, www.carstens.com
American Specialties, www.americanspecialties.com	Cascade, www.cascadesh.com
American Standard, www.americanstandard-us.com/	Ceco, www.cecodoor.com
Anemostat, www.anemostat-hvac.com	CHG, www.chgbeds.com
Archer Manufacturing, www.vandalproof.org	Chloride, www.chloridesys.com/chloride
Armstrong Ceiling Solutions, www.armstrongceilings.com	CompX, www.compx.com
Armstrong Flooring, www.armstrong.com	Comfortex, www.comfortex.com
Armstrong International, http://armstronginternational.com	Cooper, www.cooperindustries.com
Arsco, www.arscomfg.com	Cortech, www.cortechusa.com
Avonite, www.avonitesurfaces.com	CS Acrovyn, www.c-sgroup.com
BASF, www.master-builders-solutions.basf.us	Curries, www.curries.com
Behavioral Safety Products, www.besafepro.com	Custom Design Frameworks, www.customdesignframeworks.com
Best Access Solutions, Inc., http://www.bestaccess.com/index.php/products/behavioral-health-products/	Dano Group, http://www.danogroup.com
Bath, www.best-bath.com	Designplan, www.designplan.com

Inclusion or exclusion of a product does not indicate endorsement or disapproval of that product, nor does it suggest that any product is free of risk. All products must be in compliance with the Safety Risk Assessment for each location.

Dex-O-Tex, www.dexotex.com	Hospital Systems Inc., www.HospitalSystems.com
DHSI, www.dhsi-seal.com	Hubbell, www.hubbell-wiring.com
Door Control Services, www.doorcontrolsusa.com	IE; Blinds, www.ieblinds.com
Door Switch, http://thedoorswitch.com	Intersan, www.intersan.us
Draper, Inc., www.draperinc.com	Ives, http://us.allegion.com/
Dur-A-Flex, www.dur-a-flex.com	J. L. Industries, www.jlindustries.com
Dynalock Corp, www.dynalock.com	Johnsonite, www.roppe.com
Eggrock, www.eggrock.com	Kane Mfg., www.kanescreens.com
Fence Factory, www.fencefactory.com	Kawneer Company, Inc., www.kawneer.com
Filtrine Manufacturing Co.; www.filtrine.com	Kees, www.kees.com
Flexco, www.flexcofloors.com/	Kele, Inc., www.kele.com
Flxsigns, www.290signs.com	Kenall, www.kenall.com
G-Tel, www.payphone.com/	Kennon Products, www.suicideproofing.com
Glasspec Corporation, www.glasspec.com	King Architectural Products, www.kingarchitecturalproducts.com
Global, www.security-glazing.com	Kingsway Group USA www.kingswaygroupusa.com
GoJo Industries, www.GOJO.com	Kirlin, www.kirlinlighting.com
Grahan Wood Doors, www.grahamdoors.com	Kwalu, www.kwalu.com
Grainger, www.grainger.com	L. C. Doane, www.lcdoane.com
Hafele, www.hafele.com/us/index.htm	LCN, http://us.allegion.com/brands/lcn/Pages/default.aspx
Hager Companies, www.hagerco.com	Lamb Industries, www.e-switch.com
Harm Reduction Solutions, www.harmreductionsolutions.com	Lee's Carpet, www.leescarpets.com

Inclusion or exclusion of a product does not indicate endorsement or disapproval of that product, nor does it suggest that any product is free of risk. All products must be in compliance with the Safety Risk Assessment for each location.

Lonseal,
<http://lonseal.com>

Luminaire,
www.luminairelighting.com

Manko Windows,
www.mankowindows.com

Maiman,
www.maiman.com

Marathon,
www.flexcofloors.com

Markar,
<https://www.assaabloydooraccessories.us/en/local/assaabloydooraccessories/products/hinges/continuous-pin-barrel-hinges/behavioral-health-hinges/>
Marks USA,

www.marksusa.com

Marshfield Door Systems, www.marshfielddoors.com

McMaster-Carr,
www.mcmaster.com

Metalco,
www.fence-system.com

Metrasens,
www.metrasens.com

Mockett, Doug,
www.mockett.com

Moduform,
www.moduform.com

Modular Services Company,
www.modularservices.com

National Gypsum,
www.nationalgypsum.com

Nemschoff,
www.nemschoff.com

Nora Systems, Inc.;
www.nora.com/us

Norix,
www.norix.com

Northwest Specialty Hardware.
www.northwestsh.com

Norva Plastics,
www.norvaplastics.com

Odd Ball,
www.oddballindustries.com

O’Keeffe’s, Inc.,
www.safti.com

Oldcastle,
www.oldcastlebe.com

Pabco Gypsum,
www.quietrock.com

Padded Surfaces,
paddedsurfaces.com/CAD.html

Pecora,
www.pecora.com

Peerless A-V,
www.perlessmounts.com

Pineapple,
www.pineapplecontracts.com

Pinpoint,
www.pinpointinc.com

Quench;
www.quenconline.com

Quick Drain USA,
www.quickdrain.com

RAL & Associates,
www.ieblinds.com

Rauland - Borg Corp.,
www.rauland.com

Re*cesso Lights,
<http://recessolighting.com/>

Riverdale Mills,
www.wirewall.com

ROA Contract Sales,
www.rao.com

Rockwood,
www.rockwoodmfg.com

Roppe,
www.roppe.com

Sabic,
www.sabic.com

SaftiFirst (O’Keeffe’s, Inc.),
www.safti.com

Safehinge-Primera
www.safehingeprimera.com

Sani-liner,
www.wisconsinconverting.com

Inclusion or exclusion of a product does not indicate endorsement or disapproval of that product, nor does it suggest that any product is free of risk. All products must be in compliance with the Safety Risk Assessment for each location.

Sargent Lock, www.sargentlock.com	Titus, www.titus-hvac.com
Schlage, http://us.allegion.com	Top Knobs, www.myknobs.com
Scotchshield, http://solutions.3m.com/	Total Door, www.total-door.com
Securitech Group, Inc., www.securitech.com	Total Lock and Security, www.totallock.com
Sheffield, www.sheffieldplastics.com	Townsteel, www.townsteel.com
Sherwood Windows Group, www.sherwoodwindows.com	Truebro, www.truebro.com/plumbing/truebro/lavshield
Siemens Building Technology, www.siemens.com	Truth Hdw., www.truth.com
Size wise, www.size wise.net	TWA Comm, www.twacomm.com
Sloan, www.sloanvalve.com	2/90 Sign Systems, www.290signs.com
Spec, www.specfurniture.com	Tyco, www.tyco-fire.com
Stanley Hardware, www.stanleyhardware.com	Umano Medical, Inc., www.umanomedical.com
Stanley Security, www.stanleysecuritysolutions.com	Unicel, www.unicelarchitectural.com/en/index.php
Sto Americas, www.stocorp.com	USG Sheetrock, www.usg.com/content/usgcom/en.html
Stryker, www.stryker.com/en-us/products/	Vistamatic, www.vistamaticvisionpanels.com/
Sugatsune, www.sugatsune.com	Vocera, www.vocera.com
Surebond, www.surebond.com	Wausau Windows, www.wausauwindow.com
SydLo Design, LLC, lrwendt02@gmail.com	Webb Shade, www.webbshade.com
Tamperproof Screws, www.tamperproof.com	Weizel Security, www.securingshospitals.com
Technical Glass Products (TGP), www.fireglass.com	Whitehall, www.whitehallmfg.com
This End Up, www.thisendup.com	Willoughby Industries, www.willoughby-ind.com
3M, www.3m.com	Zurn, www.zurn.com

Inclusion or exclusion of a product does not indicate endorsement or disapproval of that product, nor does it suggest that any product is free of risk. All products must be in compliance with the Safety Risk Assessment for each location.